

Temptop

PMD 331

**PARTICLE COUNTER
User Manual**

Notices about this User Manual

© Copyright 2020 Elitech Technology, Inc. All Rights Reserved in the United States and other countries. It is prohibited to use, arrange, duplicate, transmit, translate, store as a part or whole of this User Manual without the written or any form of permission of Elitech Technology, Inc.

Technical Support

If you require support, please advise this User Manual to resolve your problem. If you are still experiencing difficulty or have further questions, you may contact a customer service representative during business hours Monday to Friday, 8:30 a.m. to 5:00 p.m. (Pacific Standard Time).

USA:

Tel: (+1) 408-898-2866

Email: sales@temtopus.com

China:

Tel: (+86) 400-996-0916

Email: sales@temtopus.com.cn

United Kingdom:

Tel: +44 (0) 208-858-1888

Email: sales@elitech.uk.com

Brazil:





Tel: +55 (51)-3939-8634

Email: brasil@e-elitech.com



CAUTION!

Please read this manual carefully! Use of controls or adjustments or operation other than those specified in this manual, may cause danger or damage to the monitor.

WARNING!

-  The monitor features an internal laser transmitter. Do not open the monitor housing.
-  The monitor shall be maintained by the professional from the manufacturer.
-  Unauthorized maintenance may cause hazardous radiation exposure of the operator to laser radiation.
-  Elitech Technology, Inc. accepts no responsibility for any malfunction that are caused by improper handling of this product, and such malfunction will deem as falling outside the conditions of Warranty and Services outlined in this User Manual.

IMPORTANT!

-  PMD 331 has been charged and can be used after unpacking.
-  Do not use this monitor to detect heavy smoke, high-concentration oil mist, or high-pressure gas to avoid laser tip damage or air pump block.

After opening the monitor case, make sure that the parts in the case are complete according to the following table. If anything is missing, please contact our company.

Standard Accessories



PMD 331
&
PU Protective Case



Battery Charger



RS-232 Serial
Converter Cable



AC Power Cord



Filter Tube

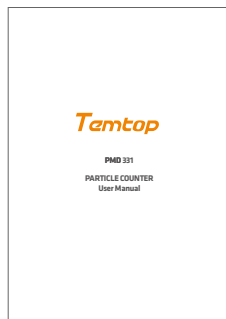

User Manual



Carrying Case



USB Flash Drive

Optional Accessories



Flow Meter



Filter Element

Table of Contents

1. Introduction	4
2. Product Overview	4
3. Operations	5
3.1 Power ON	5
3.2 Settings Menu	7
3.2.1 System Setting	7
3.2.2 System Calibration	10
3.2.3 Data History	11
3.2.4 System Information	14
3.3 Power OFF	14
4. Protocols	15
4.1 RS-232 Serial Communication	15
4.1.1 Register List	15
4.1.2 Function Code Description	17
4.1.3 Serial Setting	17
4.1.4 Application Example	17
4.2 USB Communication	19
5. Maintenance	20
5.1 Maintenance Schedule	20
5.2 Zero Calibration	20
5.3 Flow Calibration	21
5.4 Filter Element Replacement	21
5.5 Annual Maintenance	22
6. Troubleshooting	22
7. Specifications	23
8. Warranty & Services	24

1. Introduction

PMD 331 is a small, light, and battery-powered particle counter with seven channels for outputs the number of 0.3 μ m, 0.5 μ m, 0.7 μ m, 1.0 μ m, 2.5 μ m, 5.0 μ m, 10.0 μ m particles.

With a large display screen and seven buttons for operation, the monitor is simple and efficient, suitable for fast detection in multiple scenarios. The internal high-performance lithium battery allows the monitor to run continuously for 8 hours. PMD 331 also has a built-in 8GB large-capacity storage and supports two communication modes: USB and RS-232. The detected data can be viewed directly on the screen or exported through the USB port for analysis.







2. Product Overview



Fig. 1

-
- | | | | |
|---------------|-------------------|----------------------|----------------------|
| ① Intake Duct | ② Display Screen | ③ Buttons | ④ PU Protective Case |
| ⑤ USB Port | ⑥ 8.4V Power Port | ⑦ RS-232 Serial Port | |
-

Button Functions

	Hold for 2 seconds to turn on/off the instrument.
	When the instrument is on, press to enter MENU interface; In the MENU interface, press to switch options.
	Press to confirm the option.
	Press to back to the previous status.
	Press to start/stop sampling.
	Scroll up the options in the Menu interface; Increase parameter value.
	Scroll down the options in the Menu interface; Decrease parameter value.

3. Operations

3.1 Power ON

Press and hold  for 2 seconds to power on the instrument, and it will display an initialization screen (Fig 2).

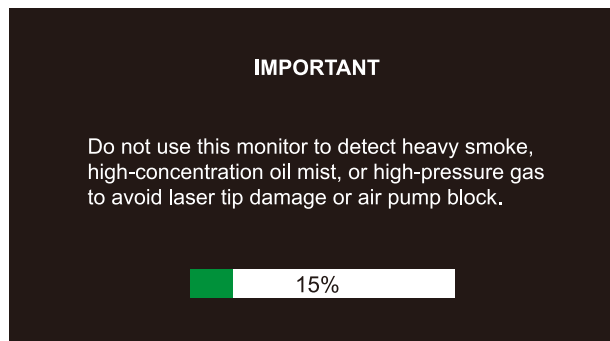

Fig. 2

After the initialization, the instrument enters the main interface. It will not start the measurement by default to save the power (Fig 3).

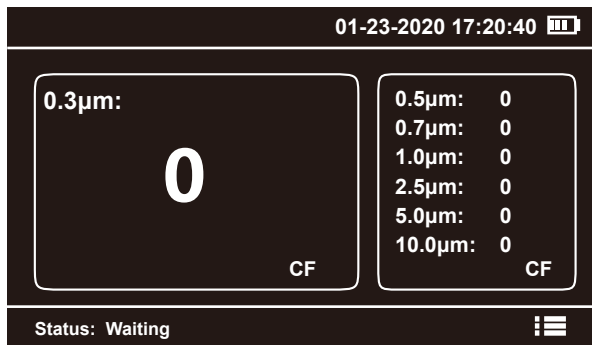



Fig. 3

Press  to start detection, and it will display the real-time data of all parameters. The instrument is factory-set with a sampling unit of CF and a sampling time of 60s (the sampling unit and time can be set as required, see **3.2.1 Sample setting** for details), and the bottom status bar displays the sampling countdown. The instrument defaults to continuous sampling. During the sampling process, you can press  to pause sampling (Fig. 4).

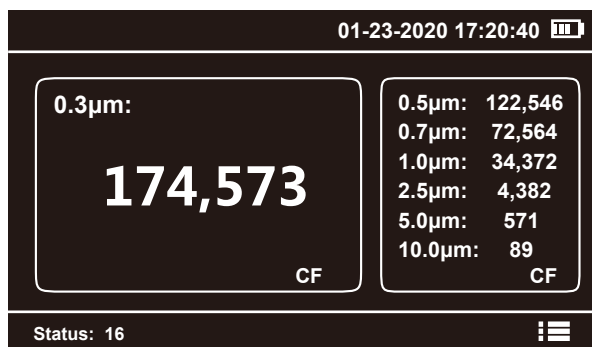



Fig. 4

The instrument default 0.3µm data is displayed in the main view box, press  or  to switch the measurement items displayed in the main view box (Fig. 5).

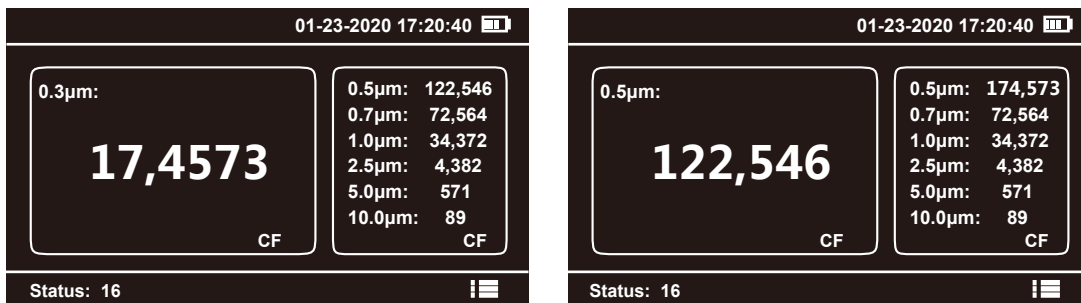





Fig 5

3.2 Settings Menu

Press  to enter the MENU interface, then press  or  to switch between the options. Press  to enter your preferred option to view or change settings (Fig. 6).

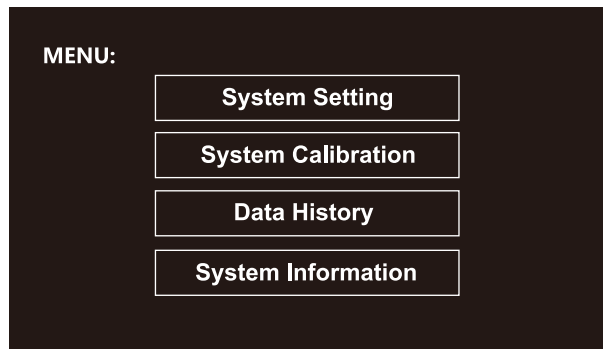





Fig. 6

MENU options are as follows:

Menu	Display as...	Description
System Setting	Setting	Set system time, sample, COM, language and backlight
System Calibration	Calibration	Calibrate zero and flow
Data History	History	Query, download and delete the data
System Information	Information	Display system information

3.2.1 System Setting

In the system setting interface MENU->Setting, you can set time, sample, COM, and language. Press  or  to switch the options (Fig. 7) and press  to enter.

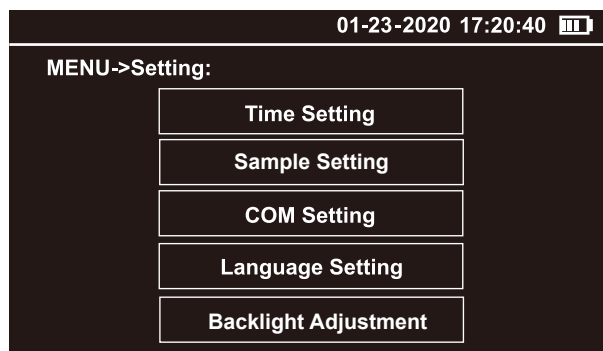

Fig. 7

• Time Setting

Press  to switch the option, press  or  to increase or decrease the value, finally switch to the option **Save** and press  to save the setting (Fig. 8).

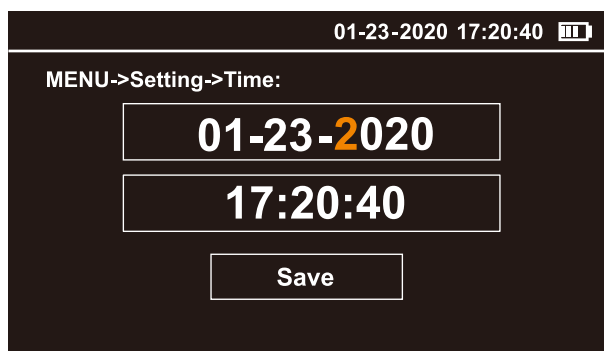





Fig. 8

• Sample Setting

In the system setting interface MENU->Setting->Sample, you can set the sample unit, sample time. Press  or  to switch the option and press  to enter.









The instrument supports three counting units: CF, L and TC. CF: number of particles per cubic foot, L: number of particles per liter, TC: total counts during the sample time. Press  or  to select, then press  to switch to **Save** and press  to save the setting (Fig. 9).



Fig. 9

The instrument supports setting the sample time in the range of 3-60s. Press  to switch the option, press  or  to increase or decrease the value, finally switch to the option **Save** and press  to save the setting (Fig. 10).

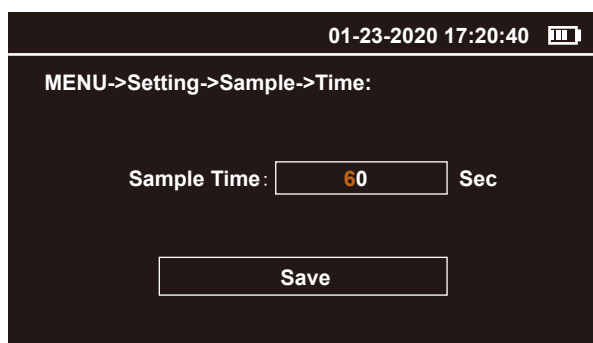





Fig. 10

• COM Setting

Press  or  to select the baud rates among three options: 9600, 19200, and 115200. Then press  to switch to **Save** and press  to save the setting (Fig. 11).

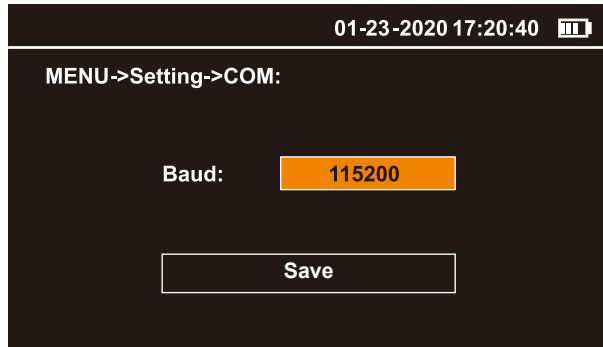





Fig. 11

• Language Setting

The instrument supports two languages, English and Chinese. Please press  or  to select the desired language, then press  to switch to **Save** and press  to save the setting (Fig. 12).

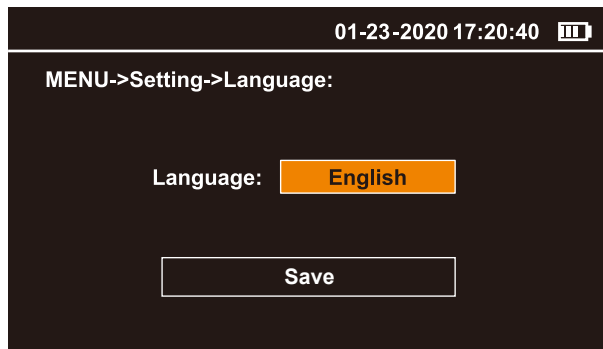





Fig. 12

The instrument supports setting the backlight in the range of 1-3. Press  to switch the option, press  or  to increase or decrease the value, finally switch to the option **Save** and press  to save the setting (Fig. 13).

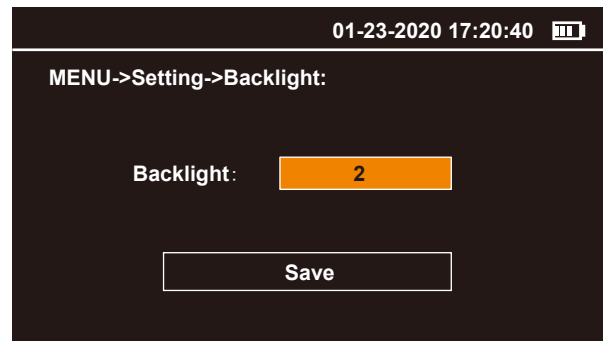

Fig. 13

3.2.2 System Calibration

In the system setting interface MENU->Calibration, you can operate Zero Calibration, K-Factor Calibration, and Flow Calibration. Press  or  to switch the option and press  to enter (Fig. 14).

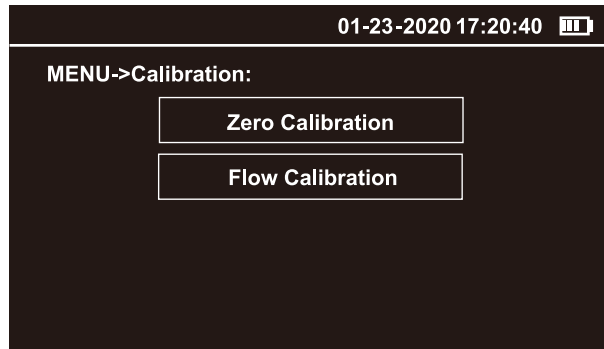



Fig. 14

• Zero Calibration

Before start, please install the filter and the air inlet according to the prompt reminder on the display. Please see **5.2 Zero Calibration** for more installation details. Press  to start the calibration. It takes about 90 seconds countdown. After the countdown finishes, the display prompts reminder to confirm the calibration finishes successfully and will return to the MENU-Calibration interface automatically (Fig. 15).

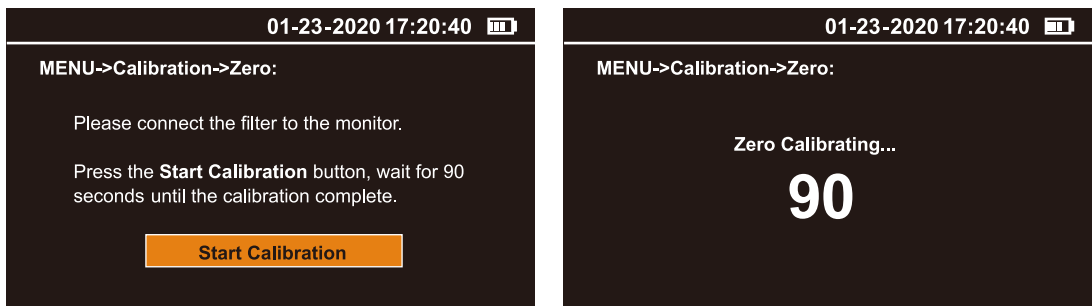





Fig. 15

• Flow Calibration

Before start, please install the flow meter to the air inlet as prompt on the display. Please see **5.3 Flow Calibration** for full installation operation.

Under Flow Calibration interface, press  to start calibrating. Then press  or  to increase or decrease the value until the flow meter reading reaches 2.83 L/min. After the setting finishes, press  to save the setting and exit (Fig. 16).

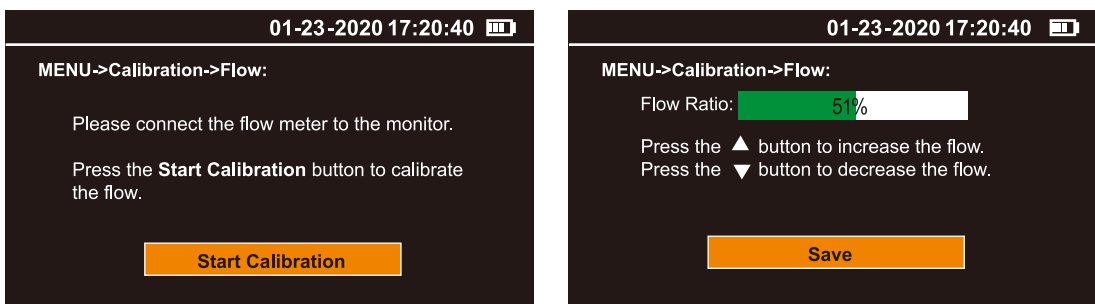





Fig. 16

3.2.3 Data History

The History menu interface allows data query, download and deletion. Press  or  to switch the options and press  to enter the corresponding interface (Fig. 17).

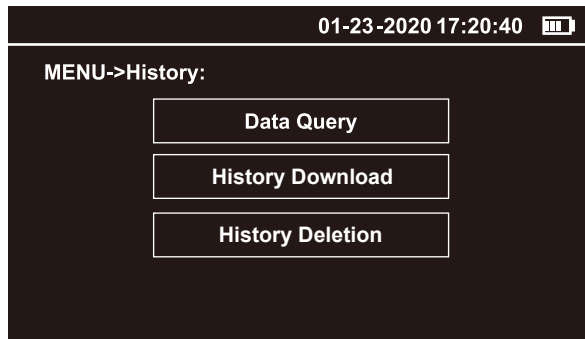







Fig. 17

• Data Query

Under the Query interface, the data can be queried by month. By default, the system will recommend the current month automatically. If you need data for other months, please press  switching to the year and month options, then press  or  to increase or decrease the value. After complete, press  to switch to **Query** and press  to enter. (Fig. 18).

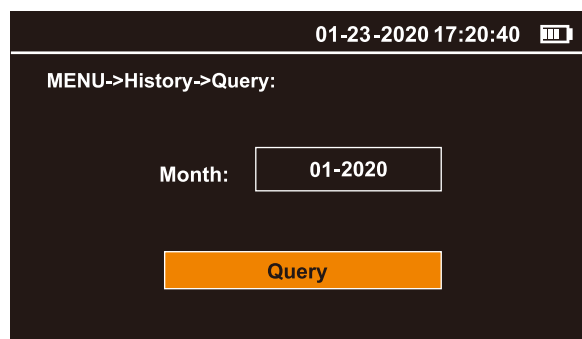



Fig. 18

The displayed data is sorted in descending time where the latest data is on the last page. Press  or  to turn the page (Fig. 19).

Page: 5312		01-23-2020 17:20:40 	
#5311	Date : 2020-01-23	Time : 14:13:10	
μm	Σ	Unit	Sample Time
0.3	103,956	CF	60 sec
0.5	16,620	CF	60 sec
0.7	9,524	CF	60 sec
1.0	5,241	CF	60 sec
2.5	4,105	CF	60 sec
5.0	3,169	CF	60 sec
10	346	CF	60 sec

Fig. 19

• Data Download

In the Download interface, insert a USB device such as a USB flash drive or card reader into the USB port of the monitor and press **OK**, the monitor will check the connection status of the USB device (Fig. 20).

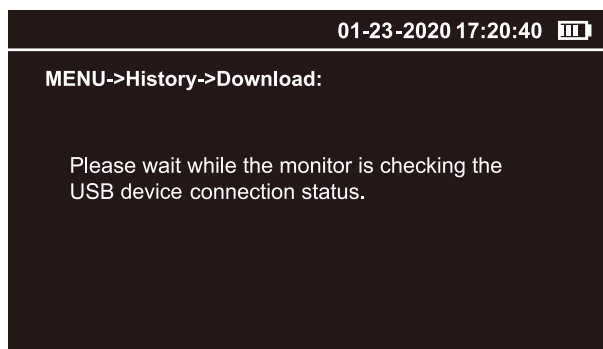

Fig. 20

If the USB device fails to connect or there is no USB device connected, the display will prompt a reminder. Please reconnect it or try again later (Fig. 21).

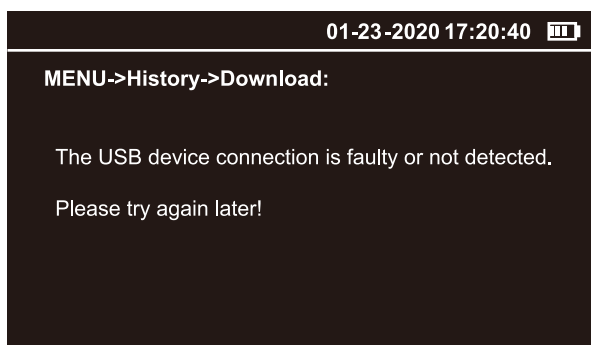

Fig. 21

If the USB device is successfully connected, press **OK** to download the data (Fig. 22).

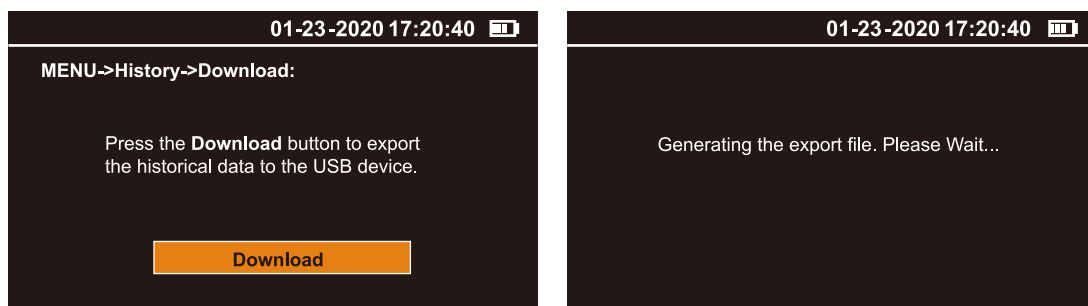

Fig. 22

After the data downloaded, unplug the USB device and insert it into the computer to find a folder named **TEMTOP**. You can view and analyze the data now.

• Data Deletion

In the Data Deletion interface, data can be deleted by month or all. Press  or  to switch options and press  to enter (Fig. 23).

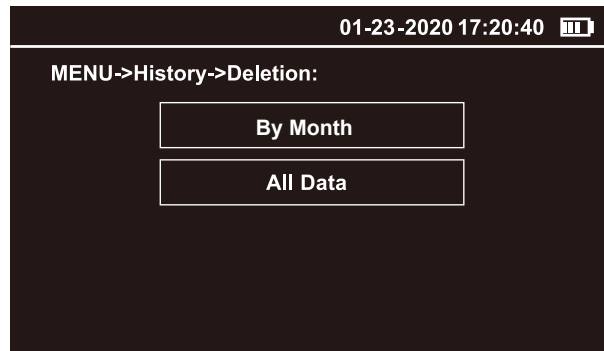







Fig. 23

For the Monthly Data interface, the current month will auto display by default. If you need to delete other months, please press  switching to the year and month options, then press  or  to increase or decrease the value. After complete, press  to switch to **Delete** and press  to complete the delete (Fig. 24).

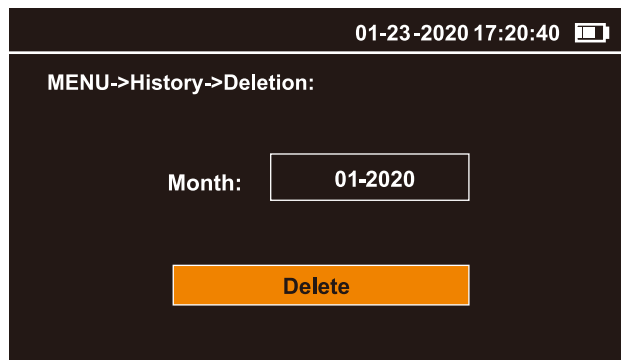



Fig. 24

For the Monthly Data and All Data interface, the display will prompt a confirmation reminder, press  to confirm it (Fig. 25).

Wait until the delete completed, if data delete successfully, then the display will prompt a reminder and will return to the MENU-History interface automatically.

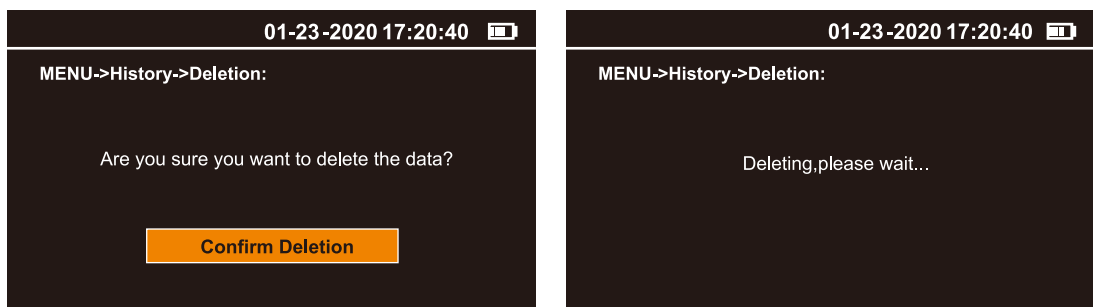

Fig. 25

3.2.4 System Information

The Information interface shows the following information (Fig. 26).

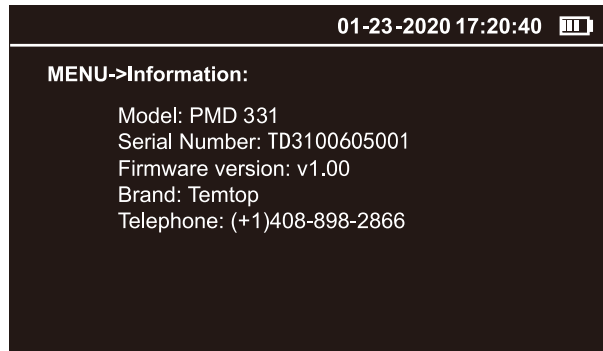



Fig. 26

3.3 Power OFF

Press and hold  for 2 seconds to turn off the monitor (Fig. 27).

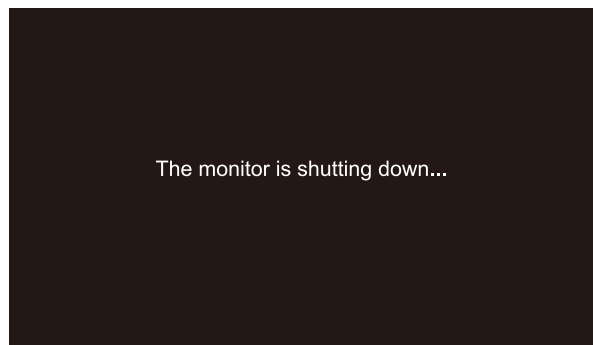

Fig. 27

4. Protocols

PMD 331 supports two communication modes: RS-232 and USB. RS-232 serial communication is used for real-time interaction. USB communication is used to export data history.

4.1 RS-232 Serial Communication

The PMD 331 is based on the Modbus RTU protocol.

Description

1) Master-Slave:

Only the master can initiate communication, as the PMD 331 is a slave and will not initiate communication.

2) Packet identification:

Any message(packet) starts with a silent interval of 3.5 characters. Another silent interval of 3.5 characters marks message end. Silence interval between characters in the message needs to be kept less than 1.5 characters.

Both intervals are from the end of Stop-bit of previous byte to the beginning of the Start-bit of the next byte.

3) Packet Length:

PMD 331 supports a maximum data packet (serial line PDU, including address byte and 2 bytes CRC) of 33 bytes.

4) Modbus Data Model:

PMD 331 has 4 main data tables (addressable registers) that can be overwritten:

- Discrete input (read-only bit)
- Coil (read / write bit)
- Input register (read-only 16-bit word, interpretation depends on application)
- Holding register (read / write 16-bit word)

Note: The sensor does not support bit-wise access to registers.

4.1.1 Register List

Restrictions:

1. Input registers and holding registers are not allowed to overlap;
2. Bit-addressable items (i.e., coils and discrete inputs) are not supported;
3. The total number of registers is limited: The input register range is 0x03~0x10, and the holding register range is 0x04~0x06, 0x64~0x69.

The register map (all registers are 16-bit words) is summarized in the table below.

Input Register List		
No.	Meaning	Description
0x00	N/A	Reserved
0x01	N/A	Reserved
0x02	N/A	Reserved
0x03	0.3µm Hi 16	Particles
0x04	0.3µm Lo 16	Particles
0x05	0.5µm Hi 16	Particles
0x06	0.5µm Lo 16	Particles
0x07	0.7µm Hi 16	Particles
0x08	0.7µm Lo 16	Particles
0x09	1.0µm Hi 16	Particles
0x0A	1.0µm Lo 16	Particles
0x0B	2.5µm Hi 16	Particles
0x0C	2.5µm Lo 16	Particles
0x0D	5.0µm Hi 16	Particles
0x0E	5.0µm Lo 16	Particles
0x0F	10µm Hi 16	Particles
0x10	10µm Lo 16	Particles

Holding Register List		
No.	Meaning	Description
0x00	N/A	Reserved
0x01	N/A	Reserved
0x02	N/A	Reserved
0x03	N/A	Reserved
0x04	Sample Unit Setting	0x00:TC 0x01:CF 0x02:L
0x05	Sample Time Setting	Sample Time
0x06	Start detection; Start detection	0x00:Stop detection 0x01:Start detection
0x64	Year	Year
0x65	Month	Month
0x66	Day	Day
0x67	Hour	Hour
0x68	Minute	Minute
0x69	Second	Second

4.1.2 Function Code Description

PMD 331 supports the following function codes:

0x03: Read holding register

0x06: Write a single holding register

0x04: Read input register

0x10: Write multiple holding register

The remaining Modbus function codes are not supported for the time being.

4.1.3 Serial Setting

Baud rate: 9600, 19200, 115200 (see **3.2.1 System Setting-COM Setting**)

Data bits: 8

Stop bit: 1

Check bit: N/A

4.1.4 Application Example

• Read Detected Data

The sensor address is 0xFE.

Use 0x04 (read input register) in Modbus to obtain detected data.

The detected data put in a register with a starting address of 0x03, the number of registers is 0x0E, and the CRC check is 0x95C1.

The master sends:

Slave Address	Function Code	Starting Address Hi	Starting Address Lo	Quantity Hi	Quantity Lo	CRC16 Hi	CRC16 Lo
0xFE	0x04	0x00	0x03	0x00	0x0E	0x95	0xC1

The slave responds:

Slave Address	Function Code	Quantity	0.3µm Hi 16 Hi	0.3µm Hi 16 Lo	0.3µm Lo 16 Hi	0.3µm Lo 16 Lo	0.5µm Hi 16 Hi	0.5µm Hi 16 Lo
0xFE	0x04	0x1C	0x00	0x02	0x34	0x24	0x00	0x02

0.5µm Lo 16 Hi	0.5µm Lo 16 Lo	0.7µm Hi 16 Hi	0.7µm Hi 16 Lo	0.7µm Lo 16 Hi	0.7µm Lo 16Lo	1.0µm Hi 16 Hi	1.0µm Hi 16 Lo	1.0µm Lo 16 Hi
0x34	0x24	0x00	0x02	0x34	0x24	0x00	0x02	0x34

1.0µm Lo 16 Lo	2.5µm Hi 16 Hi	2.5µm Hi 16 Lo	2.5µm Lo 16 Hi	2.5µm Lo 16 Lo	5.0µmHi 16 Hi	5.0µm Hi 16 Lo	5.0µm Lo 16 Hi	5.0µm Lo 16 Lo
0x24	0x00	0x02	0x34	0x24	0x00	0x00	0x08	0xE8

10.0µm Hi 16 Hi	10.0µm Hi 16 Lo	10.0µm Lo 16 Hi	10.0µm Lo 16 Lo	CRC16 Hi	CRC16 Lo
0x00	0x00	0x08	0xE8	0xD3	0xF5

- **Start Detection**

The sensor address is 0xFE.

Use 0x06 (write a single holding register) in Modbus to start the detection.

Write 0x01 to register 0x06 to start detection. The starting address is 0x01, and the registered value is 0x01. CRC calculated as 0xBC04, first sent in low byte.

The master sends:

Slave Address	Function Code	Starting Address Hi	Starting Address Lo	Value Hi	Value Lo	CRC16 Hi	CRC16 Lo
0xFE	0x06	0x00	0x06	0x00	0x01	0xBC	0x04

The slave responds:

Slave Address	Function Code	Starting Address Hi	Starting Address Lo	Value Hi	Value Lo	CRC16 Hi	CRC16 Lo
0xFE	0x06	0x00	0x06	0x00	0x01	0xBC	0x04

- **Stop Detection**

The sensor address is 0xFE.

Use 0x06 (write a single holding register) in Modbus to stop the detection.

Write 0x01 to register 0x06 to start detection. The starting address is 0x01, and the registered value is 0x00. CRC calculated as 0x7DC4, first sent in low byte.

The master sends:

Slave Address	Function Code	Starting Address Hi	Starting Address Lo	Value Hi	Value Lo	CRC16 Hi	CRC16 Lo
0xFE	0x06	0x00	0x06	0x00	0x00	0x7D	0xC4

The slave responds:

Slave Address	Function Code	Starting Address Hi	Starting Address Lo	Value Hi	Value Lo	CRC16 Hi	CRC16 Lo
0xFE	0x06	0x00	0x06	0x00	0x00	0x7D	0xC4

- **Set Time**

The sensor address is 0xFE.

Use 0x10 (write multiple holding registers) in Modbus to set the time.

In the register with start address 0x64, the number of registers is 0x06, and the number of bytes is 0x0C, which respectively correspond to the year, month, day, hour, minute, and second.

Year is 0x07E4 (actual value is 2020),

Month is 0x0005 (actual value is May),

Day is 0x001D (actual value is 29th),

Hour is 0x000D (actual value is 13),

Minute is 0x0018 (actual value is 24 minutes),

Second is 0x0000 (actual value is 0 seconds),

The CRC check is 0xEC93.

The master sends:

Slave Address	Function Code	Starting Address Hi	Starting Address Lo	Value Hi	Value Lo	Byte Count	Year Hi
0xFE	0x10	0x00	0x64	0x00	0x06	0x0C	0x07

Year Lo	Month Hi	Month Lo	Day Hi	Day Lo	Hour Hi	Hour Lo	Minute Hi
0xE4	0x00	0x05	0x00	0x1D	0x00	0x0D	0x00

Minute Lo	Second Hi	Second Lo	CRC16 Hi	CRC16 Lo
0x18	0x00	0x00	0xEC	0x93

The slave responds:

Slave Address	Function Code	Starting Address Hi	Starting Address Lo	Value Hi	Value Lo	CRC16 Hi	CRC16 Lo
0xFE	0x10	0x00	0x64	0x00	0x06	0x15	0xDB

4.2 USB Communication

Please see **3.2.3 Data History - Data Download** for detail USB operations.

5. Maintenance

5.1 Maintenance Schedule

To make better use of PMD 331, regular maintenance is required in addition to correct operation. Temtop recommends the following maintenance plan:

Service Items	Frequency	By
Zero calibration	Every week/User-defined	User/Manufacturer
Flow calibration	Every month	User/ Manufacturer
Air pump, pipeline, optical detector inspection and cleaning	Every year	Manufacturer only
Battery pack inspection	Every year	Manufacturer only

5.2 Zero Calibration

After the instrument has been used for a long time or the operating environment has been changed, the instrument should be zero-calibrated. Regular calibration is required, and the matching filter should be used for calibration by the following steps (Fig. 28):

1. Unscrew intake duct by turning it anti clockwise.

2. Insert the filter on the air inlet of the monitor. Please note that the direction of the arrow indicates the air intake direction.



Fig. 28

After the filter installed, open the Zero Calibration interface and refer to **3.2.2 System Calibration-Zero Calibration** for operation. After the calibration completed, remove the filter and screw the filter cover back.

5.3 Flow Calibration

PMD 331 sets the default flow rate to 2.83 L/min. The flow rate may change subtly due to continuous use and ambient temperature changes, thus reducing detection accuracy. Temtop offers flow calibration accessories for testing and adjusting flow.

1. Unscrew intake duct by turning it anti clockwise.

2. Insert the flow meter on the air inlet of the monitor. Please note that it should be connected downstream of the flow meter.

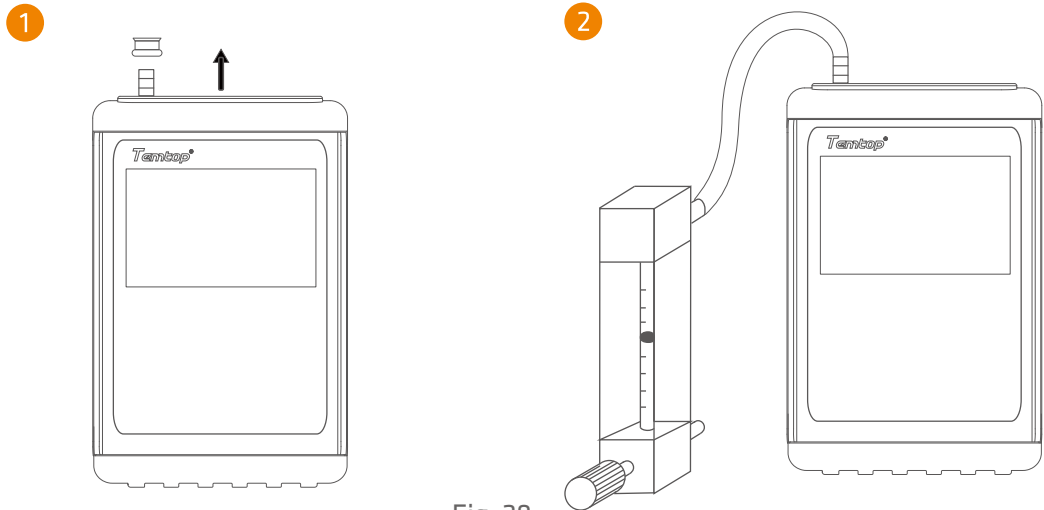

Fig. 29

After the flow meter installed, turn the adjustment knob to the maximum, and then open the Flow Calibration interface and refer to **3.2.2 System Calibration-Flow Calibration** for operation. After the calibration completed, remove the flow meter, and screw the intake duct cover back.

5.4 Filter Element Replacement

After the instrument runs for a long time or runs under high pollution conditions for a long time, the filter element will become dirty, affecting the filtering performance, and then affecting the measurement accuracy. The filter element should be replaced regularly. Temtop offers filter element accessories that can be replaced.

The replacement operation is as follows:

1. Shut down the monitor.
2. Use a coin or U-shaped screwdriver to remove the filter cover on the back of the instrument.
3. Remove the old filter element from the filter tank. If necessary, flush the filter tank with compressed air.
4. Place the new filter element in the filter tank and close the filter cover.

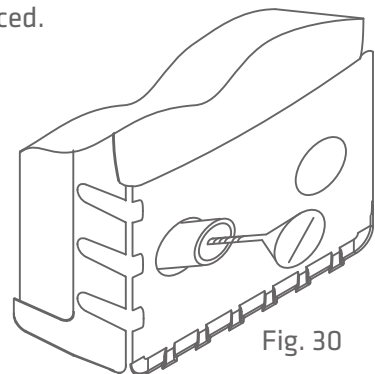

Fig. 30

5.5 Annual Maintenance

It is recommended to return PMD 331 to the manufacturer for annual calibration by specialized maintenance personnel in addition to weekly or monthly calibration by users. Annual return-to-factory maintenance also includes the following preventative items to reduce accidental failures:

- Check and clean the optical detector;
- Check air pumps and pipes;
- Cycle and test the battery.

6. Troubleshooting

Failure	Possible Causes	Solution
Noise	The flow is excessive	Flow calibration
	The pump is faulty	Send to the service center
Cannot be turned on, no display	Battery discharged	Charge the battery for 3-5 h
	The battery is faulty	Send to the service center
Display is on, but pump does not run	Low battery level	Charge the battery for 3-5 h
	The pump is faulty	Send to the service center
Detected value is not reliable	Flow deviation	Flow calibration
	Inlet screen clogged	Check the inlet screen
	Contamination inside the monitor	Replace the filter element
Send to the service center		
Unable to charge the battery	The battery is faulty	Send to the service center
	Charger failure	Contact the service center

7. Specifications

Item	Parameter	Remark
Particle Diameter	0.3、 0.5、 0.7、 1.0、 2.5、 5.0、 10.0 μ m	Both detection and display
Measurement Range	3,000,000 CF	
Accuracy	$\pm 10\%$	Calibrate aerosol
Principle	Light scattering technique	
Light Source	50mW, 780nm	
Sampling Time	3-60s	
Flow	2.83 L/min	Error $\pm 5\%$
Display	4.0" TFT LCD screen	
Communication	USB/RS-232	
Memory	2,000,000 readings	
Battery	Rechargeable lithium battery	
Charging Time	3.5h	Under normal conditions
Operating Time	8h	Continuous operation
Operating Temperature	0~50 $^{\circ}$ C	
Storage Temperature	-20~60 $^{\circ}$ C	
Monitor Dimensions	170 x 110 x 48 mm	Not include intake duct and protective case
Weight	850g	

8. Warranty & Services

Warranty: Any defective monitors can be replaced or repaired during the warranty period. However, the warranty does not cover the monitors that have been altered or modified as a result of misuse, negligence, accident, natural behavior, or the ones that are not modified by Elitech Technology, Inc.

Calibration: During the warranty period, Elitech Technology, Inc. provides free calibration services with shipping charges at the customer's expense. The monitor to be calibrated must not be contaminated by pollutants such as chemicals, biological substances, or radioactive materials. If the pollutants mentioned above have contaminated the monitor, the customer shall pay the processing fee.

Temtop warrants the included item for 5 years from the date of the original purchase.

Item	Warranty Period
Monitor	5 years included
Accessories	N/A

Note: A sincere effort was made to ensure that all information in this manual was current at the time of publication. However, final products may vary from the manual, and the specifications, features, and displays are subject to change. Please check with your Temtop representative for the latest information.

Temtop

Elitech Technology, Inc.

2528 Qume Dr, Ste 2
San Jose, CA 95131 USA
Tel: (+1) 408-898-2866
Sales: sales@temtopus.com
Website: www.temtopus.com

Elitech (UK) Limited

Unit 13 Greenwich Centre Business Park
53 Norman Road, London, SE10 9QF
Tel: +44 (0) 208-858-1888
Support: service@elitech.uk.com
Website: www.elitecheu.com

Elitech Brazil Ltda

R.Dona Rosalina,90 - Lgara, Canoas - RS,
92410-695,Brazil
Tel: +(55) 51-3939-8634
Sales: brasil@e-elitech.com
Website: www.elitechbrasil.com.br

Temtop (Shanghai) Technology Co., Ltd.

Room 3004, China Merchants Building,
161 East Lujiazui Road, Shanghai, China
Tel: (+86) 400-996-0916
Email: sales@temtopus.com.cn
Website: www.temtopus.com