

## Digital output current transmitter

Sub-plate mount, Crimping terminal output. Detect AC and pulse current, High insulation between primary side and the vice side circuit.

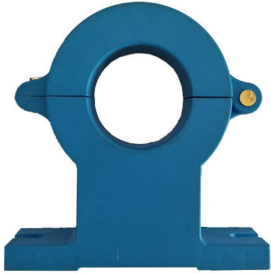

### Product features

- Light weight
- Low power consumption
- Good linearity
- No insertion loss
- Fast response time
- Good anti-interference ability

### Installation diagram

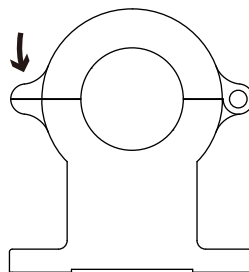

1. Loosen the screw

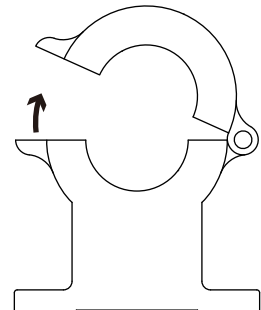

2. Open up

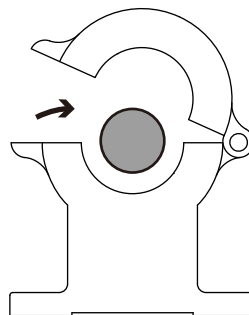

3. In the lead

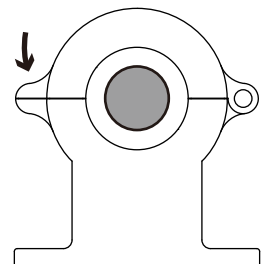

4. Tighten the screws

### Product application

- Railway
- Metallurgical
- Welding machine
- Robot
- Motor
- Inverter power supply
- Variable frequency governor
- Uninterrupted power supply and communication power supply

**Electrical parameters:** ( The following parameters are typical values and actual values will be subject to product testing )

**Remarks**

Rated input	200A	300A	500A	600A	800A	1000A	1500A	Standard input
Input measurement range	240A	360A	600A	720A	960A	1200A	1800A	Default is 1.2 times the input rating
Rated output	Hexadecimal measurements							
Accuracy	1%							
Linearity	0.5%							
Supply voltage ( $\pm 5\%$ )	$\pm 15V/+12V/+24V$							Choose three
Current consumption	$\leq 50mA$							Reference will be subject to the measured
Transmission distance	$\leq 1000m$							
Zero offset TA=25 C	$\leq \pm 15mV$							
Response time	$\leq 20ms$							500 m transmission line, baud rate is 56000bps, even check test results
Communication protocol	RS485 Modbus RTU							
Baud rate	9600bps(Acquiescence)							14400bps/19200bps/38400bps/56000bps(optional)
Device address range	0X01(Acquiescence)							0X01~0XF7(Can be modified)
Check digit	Parity check(Acquiescence)							Odd check/no check (optional)
Weight	172g							
Operation temperature	$-10 \sim +70^{\circ}C$							
Storage temperature	$-40 \sim +85^{\circ}C$							
Band width	50~60Hz							Factory test
Dielectric strength	2.5KV 50Hz 1min							

### Instruction for use:

1. Correct wiring as indicated
2. Full scale measurement, response time and following the speed for the best
3. Faulty wiring can lead to product damage and output uncertainty

### Safe operation:

- \*Please read this specification carefully before use.
- \*When you need to move the product, please be sure to disconnect the power and all the connected cables.
- \*If found shell, devices attached to the fixed parts, wire, or have any damaged, please immediately deal with hidden dangers.
- \*If there is any doubt about the safe operation of the equipment, the equipment and the corresponding accessories should be closed immediately, and the fastest time for troubleshooting.

### Proclamations:

As our products are constantly being improved and updated, we reserve the right to modify the content of this specification at any time without prior notice.

Dimensions(in mm±0.5) :

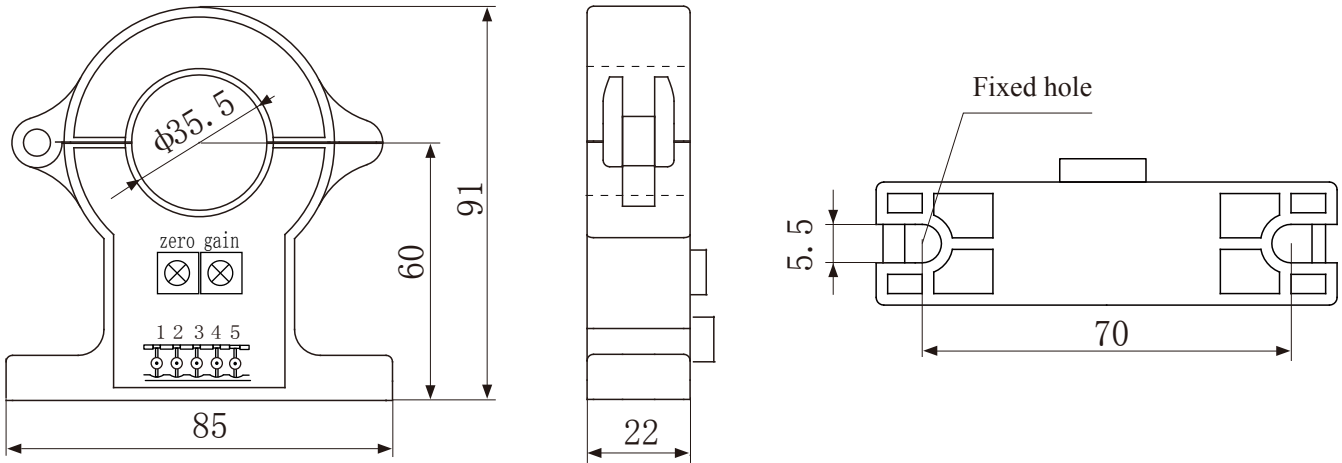

Connector Illustration:



Crimping terminal plug, spacing 5.08 mm

Wiring diagram:

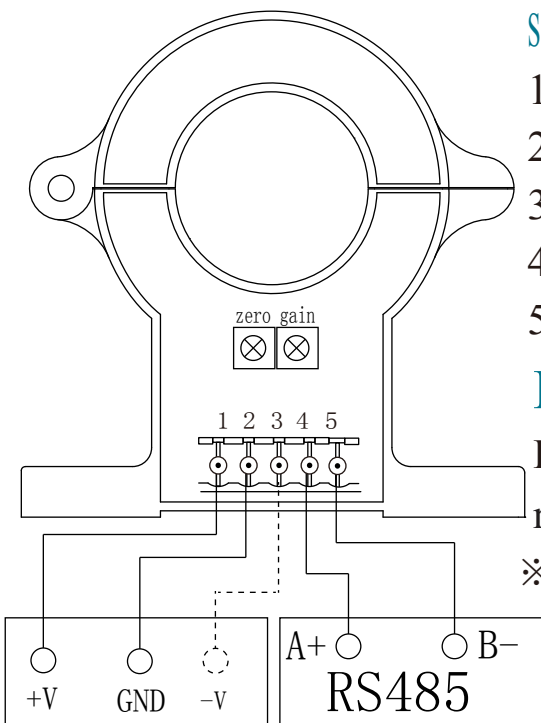

Single power terminal definition: Double power terminal definition:

- |        |        |
|--------|--------|
| 1: +V  | 1: +V  |
| 2: GND | 2: GND |
| 3: N.C | 3: -V  |
| 4: A+  | 4: A+  |
| 5: B-  | 5: B-  |

Potentiometer definition:

Left: zero  
right: gain

- ※①Choose ripple small ( $\leq 20\text{mV}$ )  
Stabilized auxiliary power supply
- ②Switch on auxiliary power
- ③Auxiliary power supply connection transmitter
- ④The transmitter detects primary current

# Communication protocol and instructions **YHDC**® 1992

Model: THST35A-RS485      Power supply:      Rated input:      Check bit: Parity check(Acquiescence)

Baud rate: 9600bps (Acquiescence)

Output signal: The serial communication RS485 interface is adopted, the transmission mode is semi-duplex asynchronous, the starting bit is 1 bit, the data bit is 8 bits, the stop bit is 1 bit, the data transmission rate is 9600bps. Use RTU mode in MODBUS communication protocol.

COMMAND(To command) :

0x01 0x03 0x00 0x01 0x00 0x01 0xD5 0xCA

RETURN(Return information) :

0x01	0x03	0x02	0x0X	0XX	0XX	0XX
Address of slave device	Function code	Register number	Data height	Low data	CRC-L	CRC-H

Start bit	Device address	Function code	Data	CRC	Check end
T1-T2-T3-T4	8Bit	8Bit	n 8Bit	16Bit	T1-T2-T3-T4

Input/Output Table (theoretical value) :

Current input (A)	RS485 output	corresponding decimal number
20%	0X0_ _ _ _ _	_ _ _ _ _
40%	0X0_ _ _ _ _	_ _ _ _ _
60%	0X0_ _ _ _ _	_ _ _ _ _
80%	0X0_ _ _ _ _	_ _ _ _ _
100%	0X0_ _ _ _ _	_ _ _ _ _
120%	0X0_ _ _ _ _	_ _ _ _ _

**Note:** (1) The input/output correspondence shall be negotiated between the manufacturer and the customer, and the signed version shall prevail

(2) 1V corresponds to the decimal number 1000 and the RS485 output is 0X03E8

2V corresponds to the decimal digit 2000, RS485 outputs 0X07D0

**Note:** Please ensure that the upper and lower parts of the sensor are tightly connected so that the measured data are accurate; The sensor is accurately calibrated before leaving the factory, and the user generally does not need to re-calibrate.