

Mini current type voltage transformer

Model: TAV14

Characteristics:TAV14is a current type voltage transformer, which USES ultra-crystal ring as the core. Different input voltages pass through current limiting resistance, so that different current flows through the primary side, and the secondary current is the same as the primary current.



Technical index:

- Mounting type: PCB mounting
- Material of the core: Nanocrystalline
- Flame resistance: UL94-V0
- Complaint with: GB1208-2006
- Operating temperature: -20 C ~+70 C
- Storage temperature: -30 C ~+80 C
- Frequency range: 20Hz-20KHz
- Dielectric strength: 3.5KV 50Hz 1min

Electrical parameters:

Rated input	5	mA
Rated output	5	mA
Turns	1500: 1500	
Linearity	0.2	%
Max. measuring voltage	380	V
Phase error(Reference)	≤30'	
Sampling resistance max	400	Ω
Weight	19.4	g

Schematic diagram:

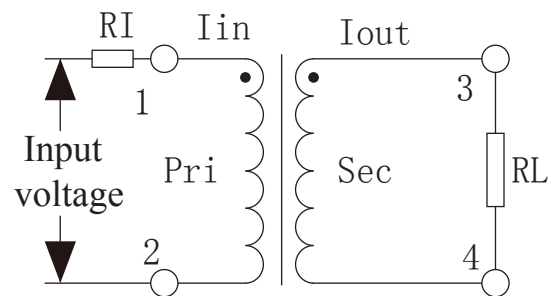

RI:Current limiting resistance

RL:Sampling resistance

Dimensions (in mm) :

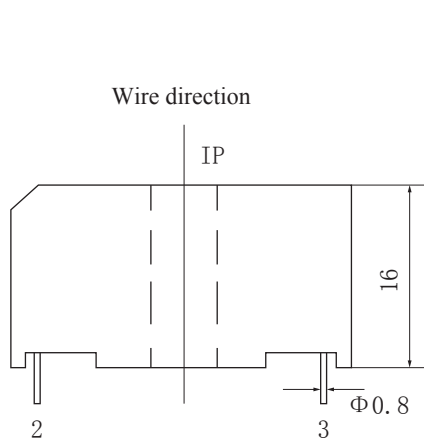

Side view

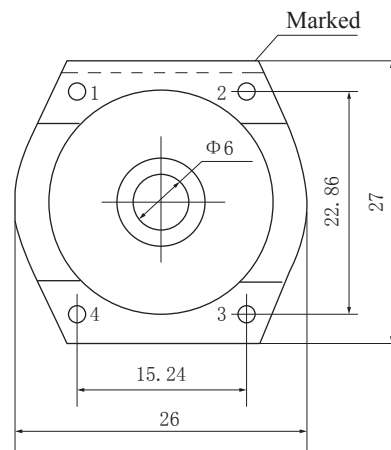

Bottom view