

Suspended type current transformer



Model:TA8420L

Characteristics:

Suspended mounting, high overload capacity. Electronics, electric power equipment current monitoring. Electric control system of current signal input. Phase loss monitoring. Monitoring the motor working condition.

Technical index:

Material of the core: Silicon steel sheet
 Flame resistance: UL94-V0
 Execution standard: GB1208-2006
 Operating temperature: $-20^{\circ}\text{C} \sim +75^{\circ}\text{C}$
 Storage temperature: $-30^{\circ}\text{C} \sim +80^{\circ}\text{C}$
 Frequency range: 50Hz ~ 60Hz
 Dielectric strength: 6KV 50Hz 1min

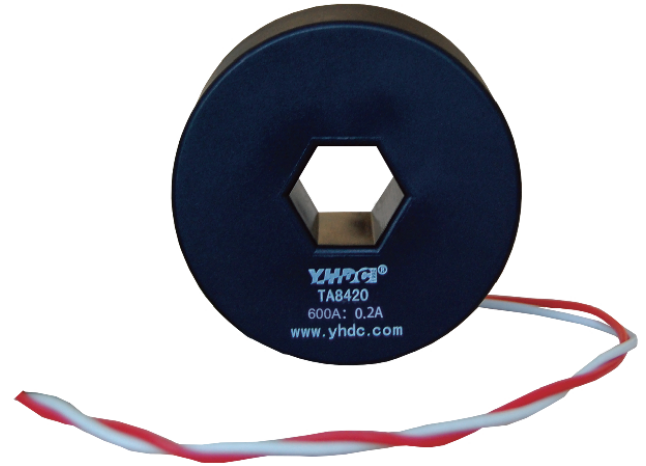

Electrical parameters:

Rated input	0-600	A
Max.input		A
Rated output	0-0.2	A
Turns ratio	1: 3000	
Accuracy	± 1	%
Linearity	0.5	%
Phase difference		
max: Max. sampling resistance	50	Ω
Weight		g

Schematic diagram:

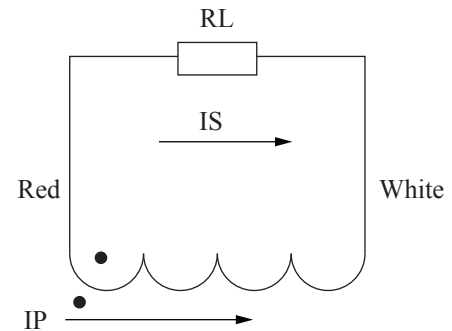

0.3 was red, white and soft line, lead to 40 cm

Dimensions (in mm) :

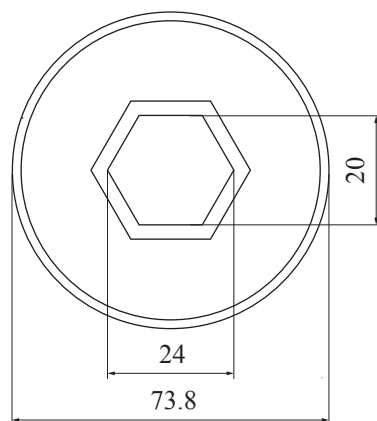

Front view

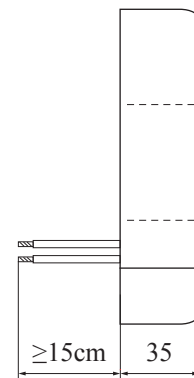

Side view