

## Model:TA2035FL-100

### Characteristics:

Vacuum epoxy resin encapsulated, silicon steel sheet core, high overload ability.

### Technical index:

- Mounting type: Plate type
- Material of the core: Silicon steel sheet
- Flame resistance: UL94-V0
- Execution standard: GB1208-2006
- Operating temperature:  $-20^{\circ}\text{C} \sim +75^{\circ}\text{C}$
- Storage temperature:  $-30^{\circ}\text{C} \sim +80^{\circ}\text{C}$
- Frequency range: 50Hz-60Hz
- Dielectric strength:  $\geq 3.5\text{KV}$  50Hz 1min

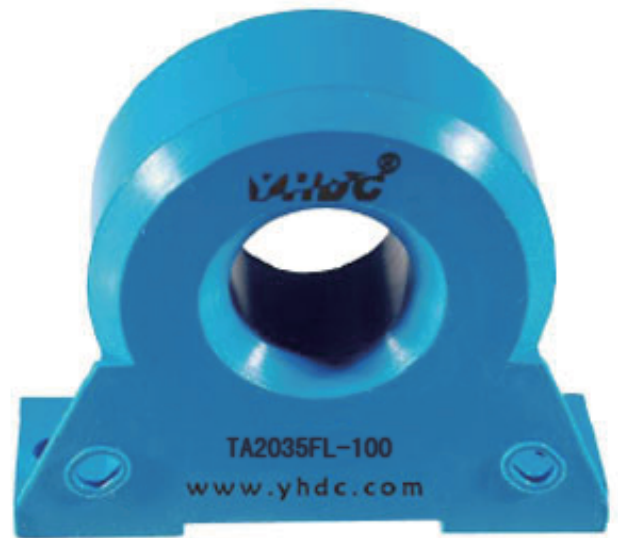

### Electrical parameters:

Rated input	0-400	A
Max.input	600	A
Rated output	0-0.4	A
Turns ratio	1: 1000	
Accuracy	$\pm 1$	%
Linearity	$\leq 0.5$	%
Phase difference	49.5'	
max: Max. sampling resistance	50	$\Omega$
Weight	335	g

### Schematic diagram:

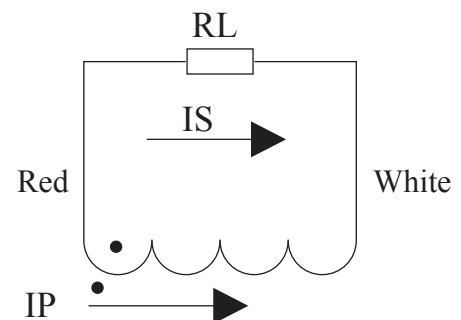

0.3mm<sup>2</sup> red and white line, leading to 40cm

### Dimensions (in mm) :

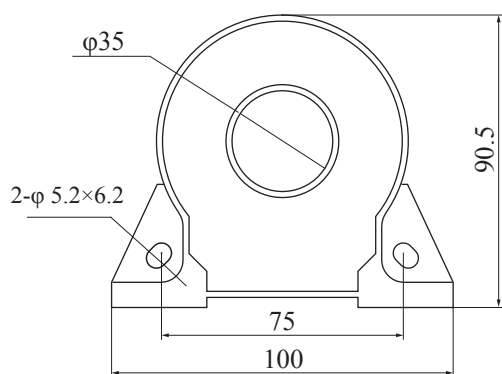

Front view

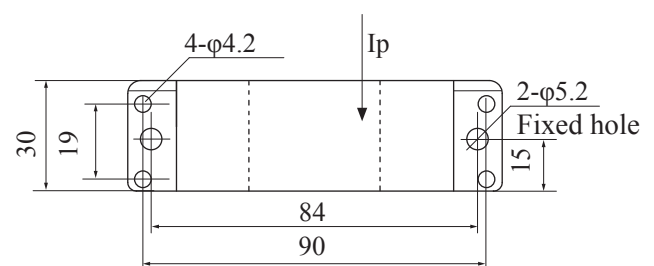

Bottom view