

# SMD5046



## IGBT, MOSFET drive and signal isolation transmission transformer

### Product application

- Medical equipment
- Aerospace equipment
- Power generation control equipment
- Electric heating equipment
- Disaster prevention security equipment
- Safety devices

### Typical technical index:

- Fair resistance: with UL94-V0
- Insulation grade: B grade (130 °C)
- Operating temperature——-25 °C ~ +70 °C
- Storage temperature: -40 °C ~ +85 °C
- Frequency range——30KHz ~ 200KHz
- Dielectric strength: Pri./Sec.3KV 50Hz AC/1min 5mA  
Sec.500V AC/1min 50Hz 5mA

### Product application

- Aerospace equipment
- Medical equipment
- Power generation control equipment
- Vehicle control equipment
- Electric heating equipment
- Disaster prevention security equipment
- Safety devices
- Other special equipment



### Standard product wiring schematic diagram:

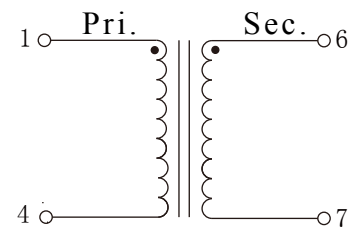

Single output  
2、3、5、8 No needle

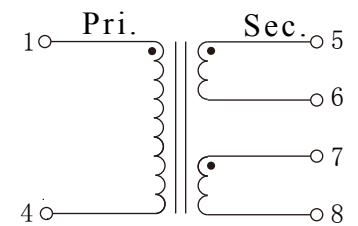

Dual output  
2、3 No needle

Electrical parameters: ( The following parameters are typical values and actual values will be subject to product testing )

Model	SMD5046	SMD5046	SMD5046	SMD5046	SMD5046	SMD5046	Unit
Project Data	-101	-201	-301	-111	-211	-311	
Vout microsecond integral	180	225	270	180	225	270	μvs
Input pulse amplitude	6	12	18	6	12	18	V
Output pulse amplitude	≥5	≥5	≥5	≥5 *2	≥5 *2	≥5 *2	V
Trigger current Max	100	100	100	100	100	100	mA
Turns ratio	1:1	2:1	3:1	1:1:1	2:1:1	3:1:1	
Load resistance	100	100	100	100	100	100	Ω
Duty ratio D=1:2	1:2	1:2	1:2	1:2	1:2	1:2	
Pulse width	30	19	15	30	19	15	μs
primary loop maximum working voltage	380	380	380	380	380	380	V
Weight	4.8	4.8	4.8	4.8	4.8	4.8	g

### Dimensions ( in mm±0.5 ) :

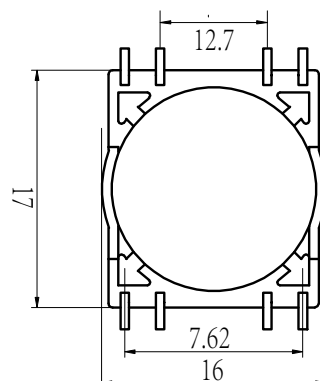
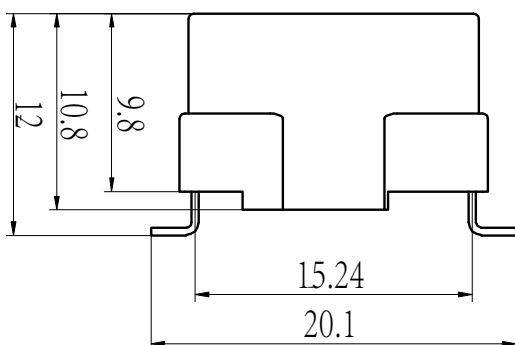

Bottom view

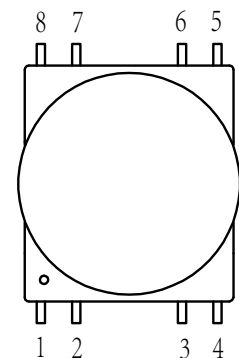

Top view

# packaging

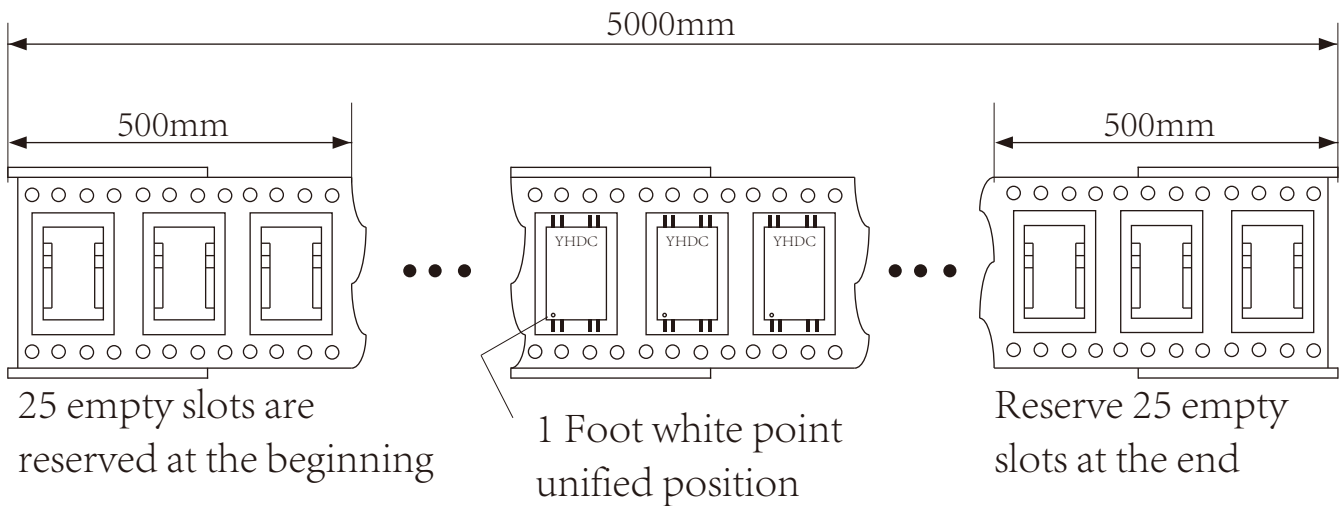
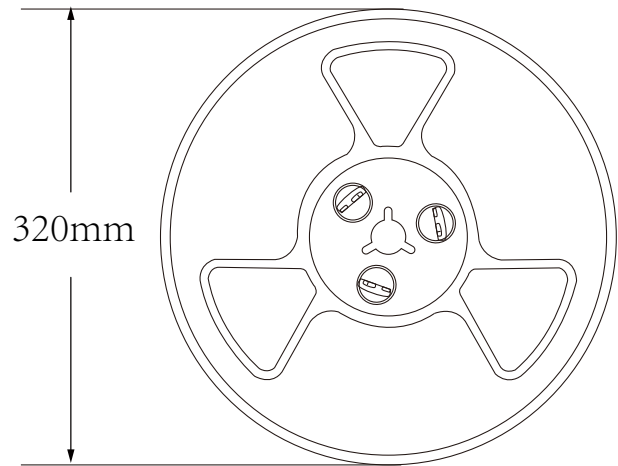

	1 pc	about4g	1pc
packing	1 salver	about1.36g	250pcs
	1 carton	about7Kg	1250pcs