

Φ65mm Aperture Split core current transformer



Front view



Opening view

Characteristic

- Opening and closing structure
- easy for installation
- Lead output
- Plate mounting

Product application

- Portable instrument
- Household metering
- Monitor motor load

Product advantage

- Economic and practical
- Improve efficiency
- High cost performance

Installation diagram

Primary threading method

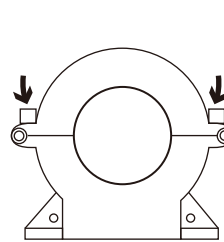

1. Unscrew the screw

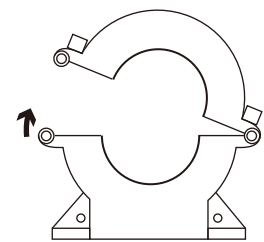

2. Open up

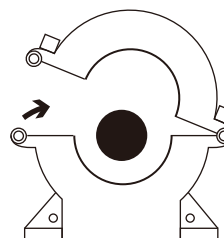

3. In the lead

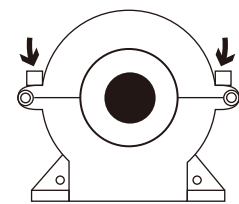

4. Buckle and screw

Typical technical index:

- Material of core——Silicon steel sheet
- Working voltage——Phase voltage $\leq 720V$
- Working temperature—— $-20^{\circ}C \sim +60^{\circ}C$
- Storage temperature—— $-25^{\circ}C \sim +65^{\circ}C$
- Frequency range—— $50Hz \sim 60Hz$
- Dielectric strength——output (outputbare conductor) AC 3.5KV/1min 5mA 50Hz
- Weight——550g

Electrical parameters: (The following parameters are typical values and actual values will be subject to product testing)

Can be made according to user requirements parameters

	Input current A	Output current A	Rated output power VA			number of turns
			0.5grade	1grade	3grade	
1A Output	100A	1A	1	2	3.75	1
	250A	1A	2	3.75	5	1
	400A	1A	2.5	3.75	5	1
	600A	1A	3.75	5	7.5	1
	800A	1A	3.75	7.5	10	1
	1000A	1A	5	7.5	10	1
	1500A	1A	5	7.5	10	1
5A Output	300A	5A	1.5	2.5	3.75	1
	400A	5A	2	3.75	5	1
	500A	5A	2.5	3.75	5	1
	600A	5A	2.5	5	7.5	1
	800A	5A	3.75	5	10	1
	1000A	5A	5	7.5	10	1
	1500A	5A	5	7.5	15	1

	Input current A	Output voltage V	Accuracy %	Sampling resistor Ω	Load resistance $K\Omega$	number of turns
0.333V Output	300A	0.333V	1%	built-in	$>10K\Omega$	1
	400A	0.333V				
	500A	0.333V				
	600A	0.333V				
	800A	0.333V				
	1000A	0.333V				
	1500A	0.333V				

Wiring diagram:

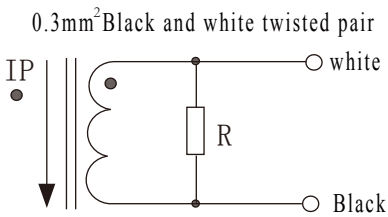

Voltage output type

Secondary are not allowed to short circuit

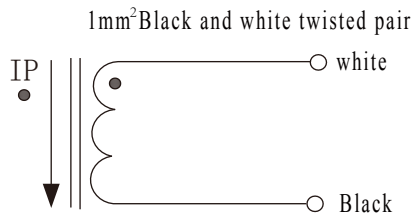

Current output type

secondary is not allowed to open the way

Cable:

Lead specification:

1mm² Black and white twisted pair
0.3mm² Black and white twisted pair

Lead color: white, Black

Lead length: 1m

Instructions:

1.Primary threading direction: mark by arrow

2.Secondary output direction:

white line → black line

Outline size: (in:mm)

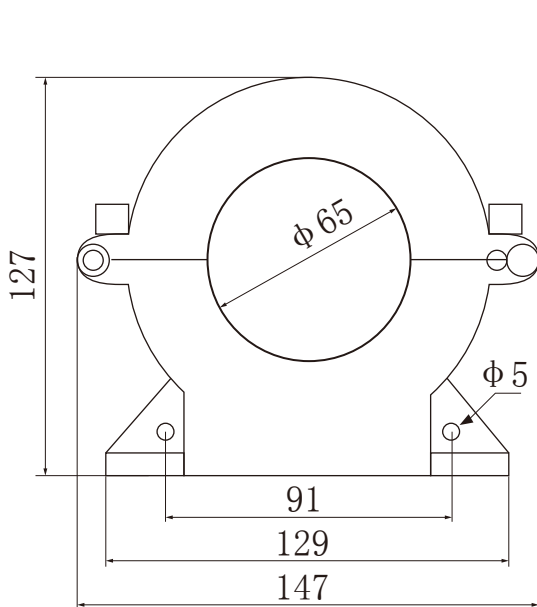

Front view

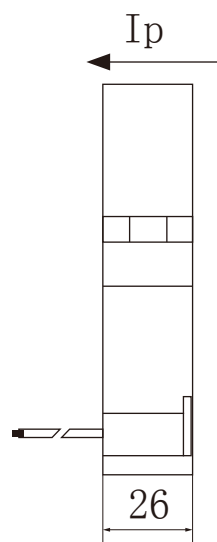

Side view

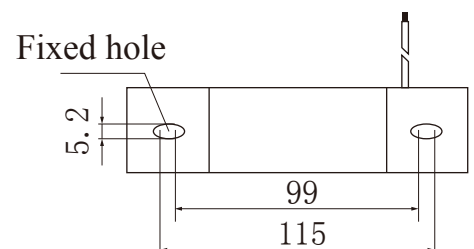

Bottom view