

Φ24mm Aperture Split core current transformer



Front view



Opening view



Terminal view

Characteristic

- Safety lock buckle, easy to install
- Crimping terminal output
- Can customize a variety of output
- Suspended type

Product application

- Portable instrument
- Household metering
- Monitor motor load

Product advantage

- Small volume, Light weight
- Low cost
- High turns, High precision

Installation diagram

Primary threading method (Firing line)

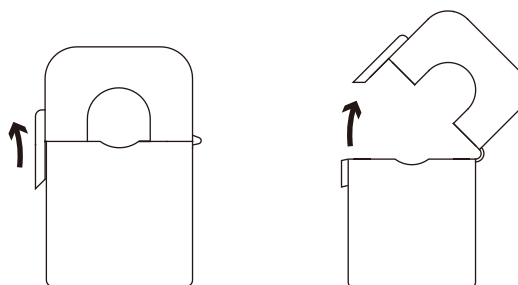

1. Open the buckle

2. Open upward

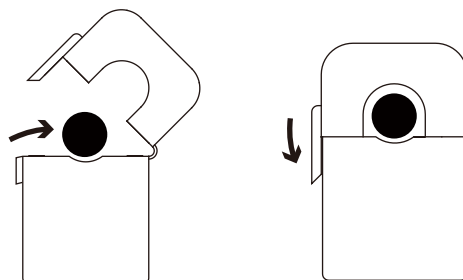

3. Put in lead wire

4. Fasten the buckle

Typical technical index:

- Material of core——Silicon steel sheet
- Working voltage——Phase voltage $\leq 720V$
- Working temperature—— $-25^{\circ}C \sim +60^{\circ}C$
- Storage temperature—— $-30^{\circ}C \sim +90^{\circ}C$
- Frequency range—— $50Hz \sim 60Hz$
- Dielectric strength——Input (bare conductor) /output AC 800V/1min 5mA 50Hz
Output/Outer shell AC 3.5KV/1min 5mA 50Hz

Electrical parameters: (The following parameters are typical values and actual values will be subject to product testing)

Model	Input current	Output	Turns ratio	Load resistance	Accuracy	Weight
SCT024TS	50A	0.1A	1:500	10 Ω	1%	204g
SCT024TS	100A	0.1A	1:1000	10 Ω	1%	204g
SCT024TS	200A	0.1A	1:2000	10 Ω	1%	204g
SCT024TS	300A	0.1A	1:3000	10 Ω	1%	204g
SCT024TS	400A	0.1A	1:4000	10 Ω	1%	204g

Model	Input current	Output	Turns ratio	Power	Accuracy	Weight
SCT024TS	50A	1A	1:50	0.5VA	1%	204g
SCT024TS	100A	1A	1:100	1VA	1%	204g
SCT024TS	200A	1A	1:200	1.5VA	0.5%/1%	204g
SCT024TS	300A	1A	1:300	2VA	0.5%/1%	204g
SCT024TS	400A	1A	1:400	2VA	1%	204g

Model	Input current	Output	Turns ratio	Power	Accuracy	Weight
SCT024TS	100A	5A	1:20	0.1VA	1%/5%	204g
SCT024TS	150A	5A	1:30	0.5VA	1%	204g
SCT024TS	200A	5A	1:40	1.5VA	0.5%/1%	204g
SCT024TS	300A	5A	1:60	2VA	0.5%/1%	204g

Model	Input current	Output	Turns ratio	Load resistance	Accuracy	Weight
SCT024TS	50A	0.333V	-	built-in	1%	204g
SCT024TS	100A	0.333V	-	built-in	1%	204g
SCT024TS	200A	0.333V	-	built-in	1%	204g
SCT024TS	300A	0.333V	-	built-in	1%	204g
SCT024TS	400A	0.333V	-	built-in	1%	204g

Wiring schematic diagram:

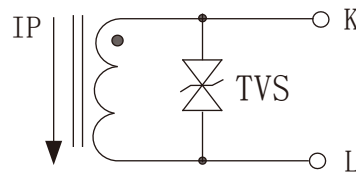
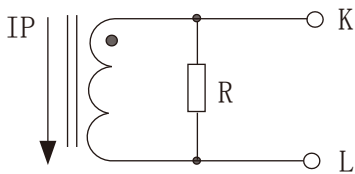

Built-in sampling resistance

Voltage output type

Secondary doesn't allow short circuit

TVS: Transient voltage suppressor (5 A output without)

Current output type

Secondary doesn't allow open circuit

Outline size: (in:mm):

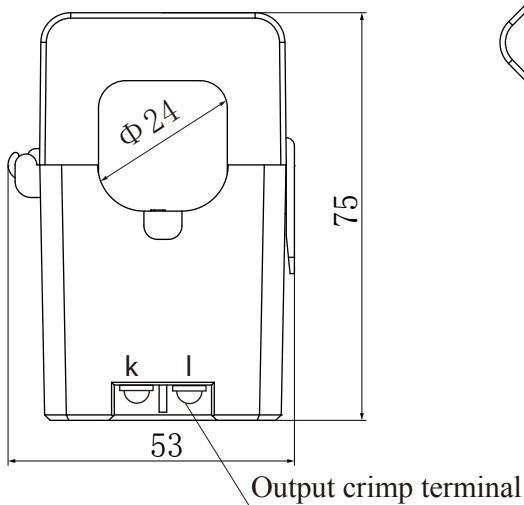

Front view

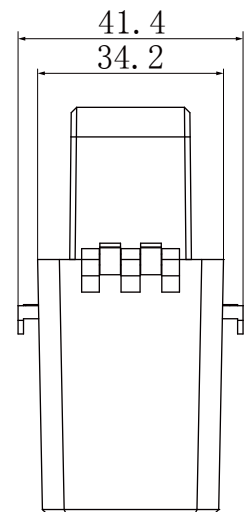
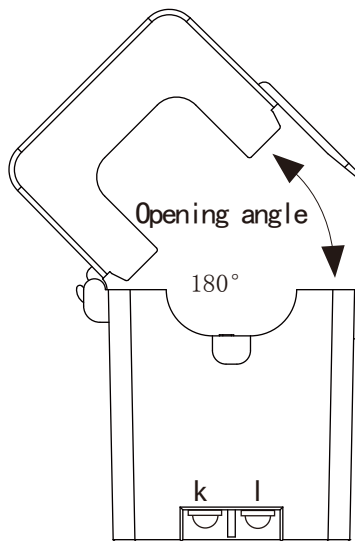

Side view