

Φ24 mm diameter Split core current transformer



Product features

- Secure locking buckle, easy to install
- Leading wire output(Three lead specifications)
- Can customize a variety of output
- Suspended mounting

Product application

- Portable instrument
- Household metering
- Monitoring the load of machine

Product advantage

- Small volume, Light weight
- Low cost
- High turns, High precision

Installation diagram

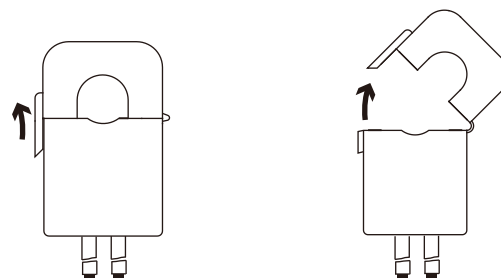

1. Open the buckle 2. Open upward

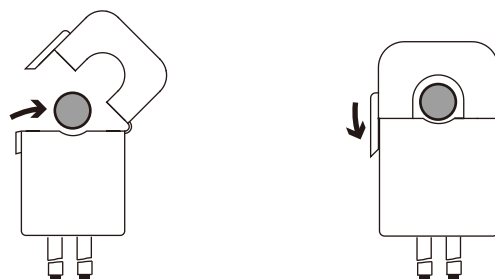

3. Put in lead wire 4. Fasten the buckle

Typical technical index:

- Material of core——Silicon steel sheet
- Working voltage——Phase voltage $\leq 720V$
- Working temperature—— $-25^{\circ}C \sim +60^{\circ}C$
- Storage temperature—— $-30^{\circ}C \sim +90^{\circ}C$
- Frequency range—— $50Hz \sim 60Hz$
- Dielectric strength——
input (Bare conductor) /output AC 800V/1min 5mA 50Hz
output/outshell AC 3.5KV/1min 5mA 50Hz)
- Weight———220g

Electrical parameters (The following parameters are typical values. The actual values shall be subject to the

1A output type						Dimensions ①
Model	Input current AC	output AC	Turns ratio	Accuracy	Lead specification	Diagram
SCT024TSL	50A	1A	50 : 1	1%	Leading wire specification: 0.5mm ² Black and white twisted pair lead length:100cm~105cm Lead wire Color:white,black	<p>current output type. the secondary is not allowed to open.</p>
SCT024TSL	100A	1A	100 : 1	1%		
SCT024TSL	150A	1A	150 : 1	1%		
SCT024TSL	200A	1A	200 : 1	1%		
SCT024TSL	250A	1A	250 : 1	1%		
SCT024TSL	300A	1A	300 : 1	1%		
SCT024TSL	350A	1A	350 : 1	1%		
SCT024TSL	400A	1A	400 : 1	1%		

5A output type						Dimensions ①
Model	Input current AC	output AC	Turns ratio	Accuracy	Lead specification	Diagram
SCT024TSL	100A	5A	100 : 5	2%	Leading wire specification: 2.5mm ² Jinwen soft wire lead length:100cm~105cm Lead wire Color:white,blue	<p>current output type. the secondary is not allowed to open.</p>
SCT024TSL	150A	5A	150 : 5	1%		
SCT024TSL	200A	5A	200 : 5	1%		
SCT024TSL	250A	5A	250 : 5	1%		
SCT024TSL	300A	5A	300 : 5	1%		

mA output type						Dimensions②
Model	Input current	output current	Turns ratio	Accuracy	sampling resistance	Lead specification/schematic diagram
SCT024TSL	50A	50mA	1:1000	1%	20 Ω	<p>Leading wire specification: 2x0.2mm² Two core shielded wire lead length: 100cm~105cm</p> <p>TVS: Transient voltage suppressor(7.5V) current output type. the secondary is not allowed to open.</p>
SCT024TSL	100A	50mA	1:2000	1%	20 Ω	
SCT024TSL	200A	20mA	1:10000	1%	50 Ω	
SCT024TSL	200A	50mA	1:4000	1%	20 Ω	
SCT024TSL	300A	50mA	1:6000	1%	20 Ω	
SCT024TSL	400A	50mA	1:8000	1%	20 Ω	
SCT024TSL	400A	80mA	1:5000	1%	20 Ω	
SCT024TSL	400A	100mA	1:4000	1%	8 Ω	

0.333V/1V/3V/5V AC voltage output type						Dimensions②
Model	Input current	Output voltage AC	Accuracy	Load impedance	Lead specification/schematic diagram	
SCT024TSL	50A	0.333V	1%	≥ 10K Ω	<p>Leading wire specification: 2x0.2mm² Two core shielded wire lead length: 100cm~105cm</p> <p>sampling resistance built-in voltage output type not allowed secondary short circuit</p>	
SCT024TSL	100A	or 1V				
SCT024TSL	200A	or 3V				
SCT024TSL	300A	or				
SCT024TSL	400A	5V				

Dimensions① : (in:mm ± 0.5)

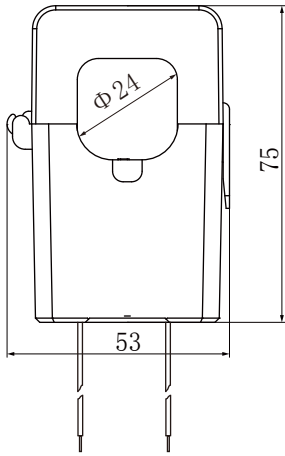

Front view

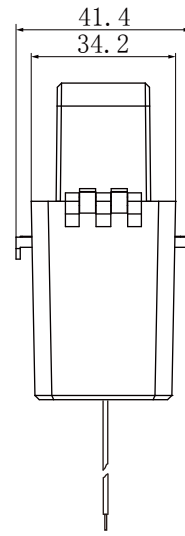
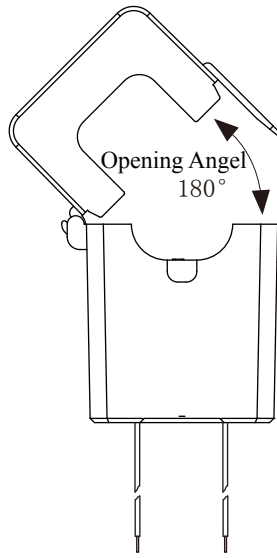

Side view

Dimensions② : (in:mm ± 0.5)

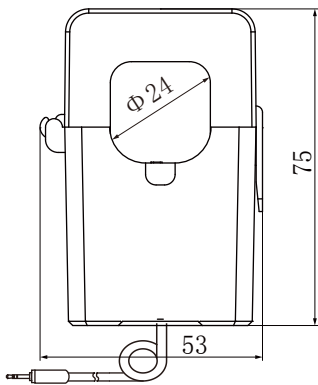

Front view

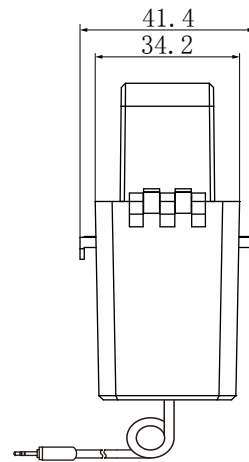
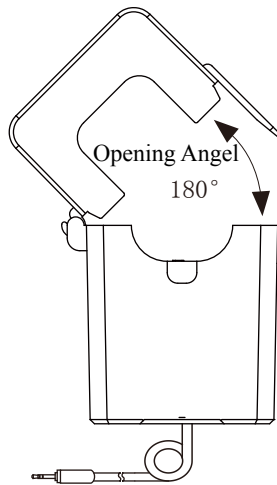

Side view

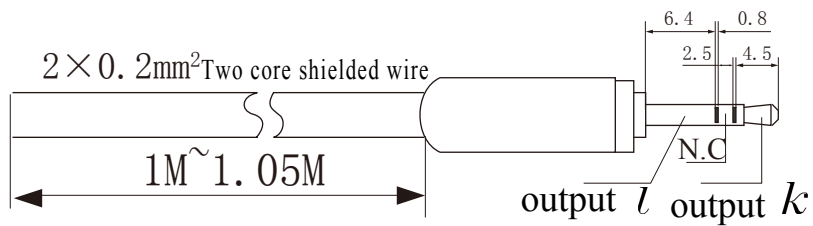

Standard Φ3.5mm three-pin plug diagram