

Φ 13mm Aperture Split core current transformer



Front view



Opening view

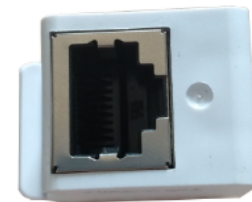

Bottom view

**Product features**

- Safety lock buckle, simple installation
- RJ45 interface output
- Suspended type

**Installation diagram**

Primary threading method:

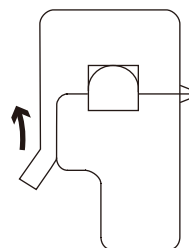

1. Open the buckle

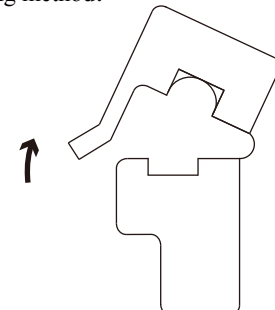

2. Open upward

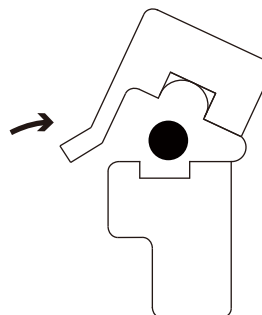

3. Put in lead wire

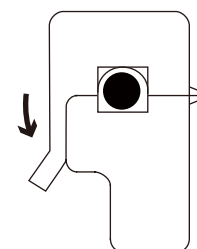

4. Fasten the buckle

**Product application**

- Portable instrument
- Household metering
- Monitoring the load of machine

**Product advantage**

- Small volume, Light weight
- Low cost
- High turns, High precision

**Typical technical index:**

- Material of core——Ferrite
- Working voltage——Phase voltage  $\leq 720V$
- Working temperature—— $-25^{\circ}C \sim +60^{\circ}C$
- Storage temperature—— $-30^{\circ}C \sim +90^{\circ}C$
- Frequency range—— $50Hz \sim 1KHz$
- Dielectric strength——Input (bare conductor) /output AC 800V/1min 5mA 50Hz  
Output/Outer shell AC 3.5KV/1min 5mA 50Hz

**Electrical parameters: ( The following parameters are typical values and actual values will be subject to product testing )**

Model	Input current	Output	Turns ratio	Load resistance	Accuracy	Linearity	Weight
SCT013-RJ45	100A	50mA	1: 2000	10 $\Omega$	1%	1%	47g
SCT013-RJ45	5A	1V	-	built-in	1%	1%	47g
SCT013-RJ45	10A	1V	-	built-in	1%	1%	47g
SCT013-RJ45	15A	1V	-	built-in	1%	1%	47g
SCT013-RJ45	20A	1V	-	built-in	1%	1%	47g
SCT013-RJ45	25A	1V	-	built-in	1%	1%	47g
SCT013-RJ45	30A	1V	-	built-in	1%	1%	47g
SCT013-RJ45	50A	1V	-	built-in	1%	1%	47g
SCT013-RJ45	60A	1V	-	built-in	1%	1%	47g
SCT013-RJ45	100A	1V	-	built-in	1%	1%	47g

Model	Input current	Output	Turns ratio	Load resistance	Accuracy	Linearity	Weight
SCT013-RJ45	5A	0.333V	-	built-in	1%	1%	47g
SCT013-RJ45	10A	0.333V	-	built-in	1%	1%	47g
SCT013-RJ45	15A	0.333V	-	built-in	1%	1%	47g
SCT013-RJ45	20A	0.333V	-	built-in	1%	1%	47g
SCT013-RJ45	25A	0.333V	-	built-in	1%	1%	47g
SCT013-RJ45	30A	0.333V	-	built-in	1%	1%	47g
SCT013-RJ45	50A	0.333V	-	built-in	1%	1%	47g
SCT013-RJ45	60A	0.333V	-	built-in	1%	1%	47g
SCT013-RJ45	100A	0.333V	-	built-in	1%	1%	47g

**\*Can be customized parameters**

Wiring schematic diagram :

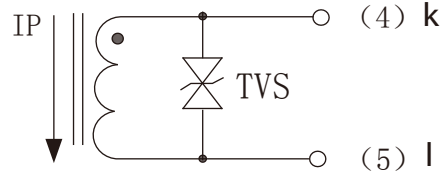
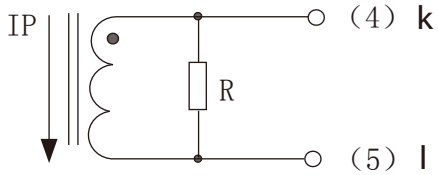

Built-in sampling resistance

Voltage output type

Secondary doesn't allow short circuit

TVS: Transient voltage suppressor

Current output type

Secondary doesn't allow open circuit

Outline size (in mm  $\pm 0.5$ ) :

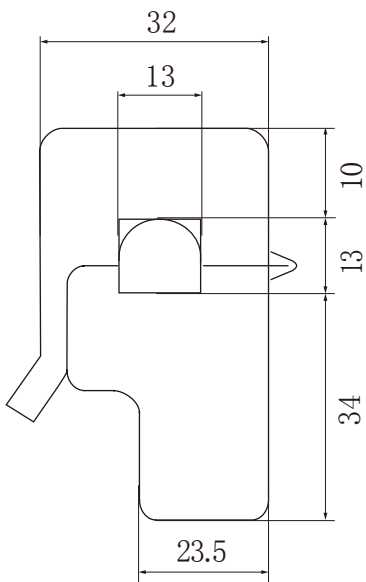

Front view

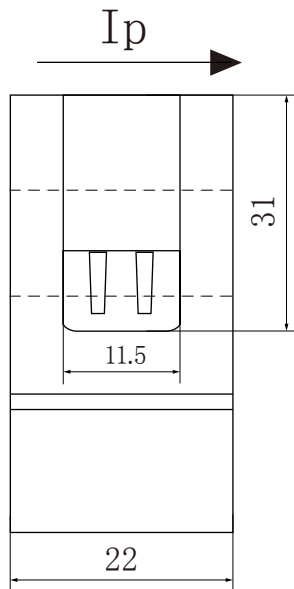

Side view

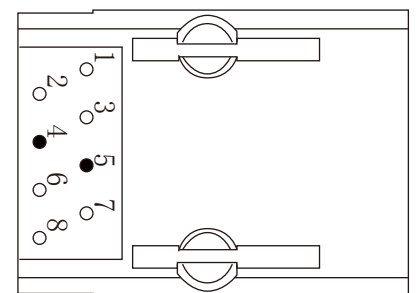

Interface terminal diagram

