

Φ6mm Aperture Split core current transformer



Front view



Opening view

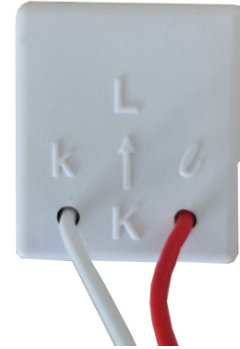

Bottom view

Characteristic

- Safety lock buckle, easy to install
- Built-in over-voltage protection device (TVS tube)
- Lead type output, length can be customized
- Suspended type

Product application

- Portable instrument
- Household metering
- Monitor motor load

Product advantage

- Small volume, Light weight
- Low cost
- High turns, High precision

Installation diagram

Primary threading method



1. Open the buckle

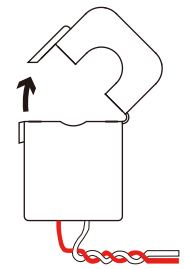

2. Open upward

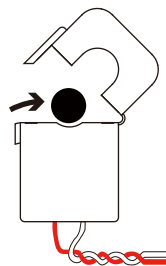

3. Put in lead wire

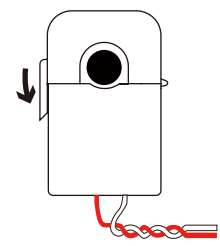

4. Fasten the buckle

Typical technical index:

- Material of core——Ferrite
- Working voltage——Phase voltage $\leq 720V$
- Working temperature—— $-25^{\circ}C \sim +60^{\circ}C$
- Storage temperature—— $-30^{\circ}C \sim +90^{\circ}C$
- Frequency range—— $50Hz \sim 1KHz$
- Dielectric strength——Input (bare conductor) /output AC 800V/1min 5mA 50Hz
Output/Outer shell AC 3.5KV/1min 5mA 50Hz

Electrical parameters: (The following parameters are typical values and actual values will be subject to product testing)

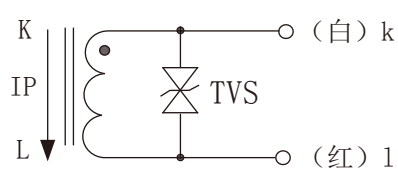
Model	Input current	Output voltage	Tums ratio	Accuracy	Sampling resistance	Lead specification/schematic diagram
SCT006	1A	1mA	1:1000	1%	5 Ω	Leading wire specification: 0.35mm ² Red and white high temperature wire lead length: 30cm~32cm 
SCT006	5A	2.5mA	1:2000	1%	10 Ω	
SCT006	5A	5mA	1:1000	1%	5 Ω	
SCT006	5A	10mA	1:500	1%	5 Ω	
SCT006	10A	5mA	1:2000	1%	10 Ω	
SCT006	10A	10mA	1:1000	1%	5 Ω	
SCT006	10A	20mA	1:500	1%	5 Ω	
SCT006	20A	20mA	1:1000	1%	5 Ω	
SCT006	20A	25mA	1:800	1%	5 Ω	

TVS: Transient voltage suppressor
current output type.
the secondary is not allowed to open.

*Can be customized parameters/lead length/lead specifications according to user requirements.

Wiring schematic diagram:

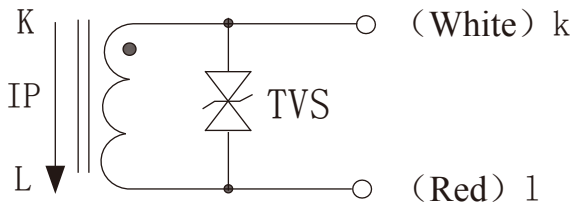

Cable:

Specifications of lead wire: 0.35mm² Red and white
 high temperature wire
 length of lead wire: 30cm
 color of lead wire: White, Red

TVS: Transient voltage suppressor
 Current output type
 Secondary doesn't allow open circuit

Outline size: (in:mm):

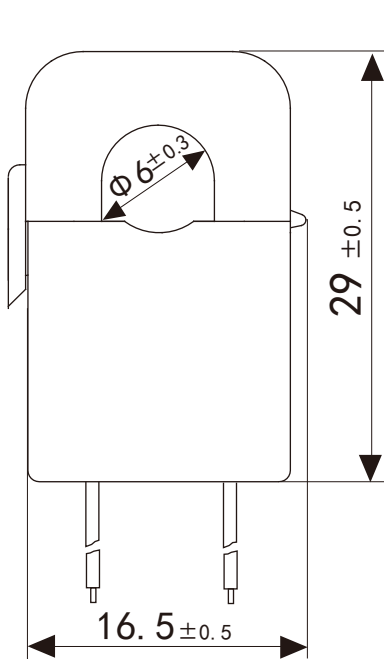

Front view

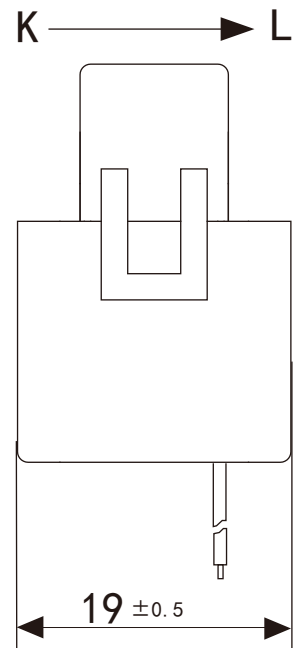
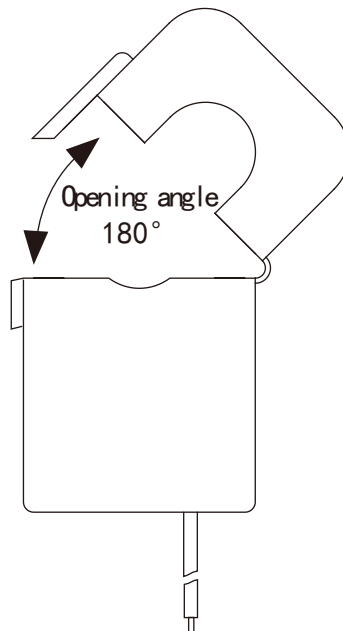

Side view

