

High Isolated Voltage SCR Trigger Transformer



Model:KMG308-201

characteristics:

High electrical strength,It applies to SCR or IGBT of rated current above 1000A.Main circuit maximum operating voltage is 2000V,KMG208 is amorphous core.Applicable for triggering of SCR over 1000A.

Technical indicators:

- Installation method: PCB
- Flame resistance: UL94-V0
- Operating temperature: -20°C~+50°C
- Storage temperature: -40°C~+85°C
- Frequency range: 1KHz~10KHz
- Dielectric strength: >15KV 50Hz 1min



Electrical parameters:

Vout microsecond integral	1600	μvs
Pulse width (D=1:2)	100	μs
Ratio	2:1	
Input amplitude	16	V
Output amplitude	≥6	V
Load impedance	7 Ω	Ω
Leading edge time	<10	μs
Main circuit operating voltage	3000	V
Weight		g

Dimensions (in mm) :

Connection diagram:

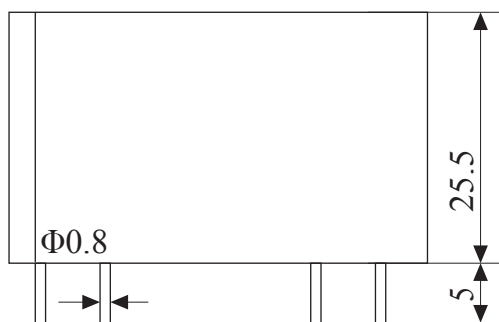
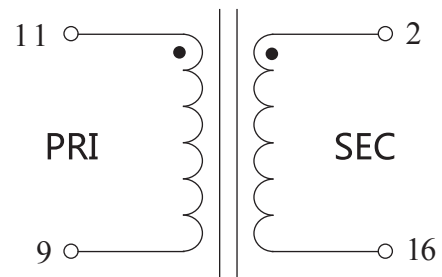

Front View

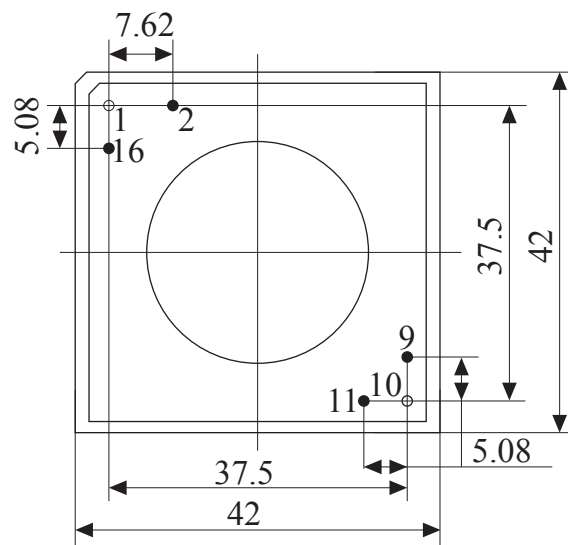

Bottom View