

# Universal SCR Trigger Transformer



Model:KMB229-101

characteristics:

It uses EI high quality magnetic core,overcoming shortcoming of toroidal core.The first pulse current amplitude is greater than 1A. applicable for SCR below 500A.

Technical indicators:

- Installation method: PCB
- Flame resistance: UL94-V0
- Operating temperature: -20°C~+50°C
- Storage temperature: -40°C~+85°C
- Frequency range: 1KHz~10KHz
- Dielectric strength: 5KV 50Hz 1min



Electrical parameters:

Vout microsecond integral	960	μvs
Pulse width (D=1:2)	120	μs
Ratio	1:1	
Input amplitude	8	V
Output amplitude	≥5	V
Load impedance	7	Ω
Leading edge time	≤5	μs
Main circuit operating voltage	660	V
Weight		g

Connection diagram:

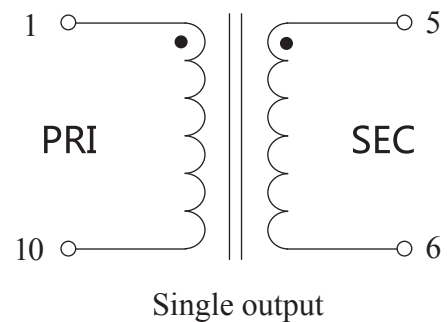

Dimensions (in mm) :

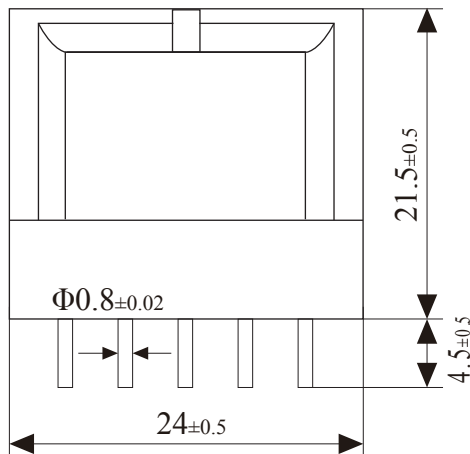

Front View

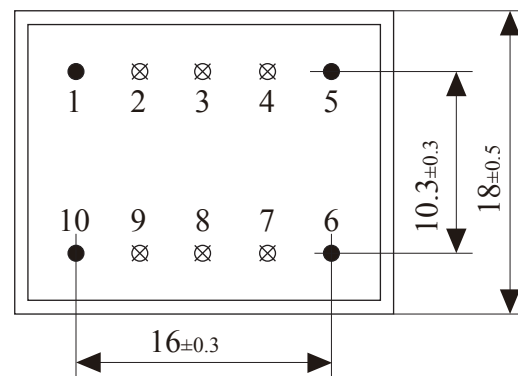

Bottom View