

machinery control transformer

JBK5 series machinery control transformer is produced by high permeability material, Silicon sheets, bottom plate and silicon sheets are welded in a group by arc, Frame is simple, Bottom plate increases the reliability to the GND by using anti-corrosion alloy material, Crimp terminal using group structure, increases the Electrical clearance & creepage distance and cable intensives, Protection class IP20, To prevent the risk of occasional access to the circuit, the transformer are used for 50-60Hz AC, Primary voltage is no more than 500V, secondary rated voltage is no more than 400V, can be as the general electric control power in mechanical equipment in industry, the power of Work lighting and signal lights.



Product application

- Power industry
- Oil industry
- Military engineering
- Chemical industry

Product advantage

- Good stability
- Low noise
- Power is sufficient
- Small idle current

Product features

- single crystal copper enameled wire
- High quality iron core-H18/0.35(annealing)
- EI silicon steel sheet adopts joint welding technology, Low loss, Low temperature
- Reasonable structure, Easy installation, Low noise, Strong earthquake

Typical technical index:

- Material of core——Silicon steel sheet
- Insulation grade: B grade (130℃)
- Operation temperature——-30℃~+40℃
- Frequency range——50Hz~60Hz
- Fair resistance: with UL94-V0
- Form test: Pri./Sec.3.5KV AC/1min 5mA (Multiple output: Sec.500V AC/1min 5mA)
(The samples for it is destructive experiment of samples, not recommended for normal use)
- Factory test: Pri./Sec.3.5KV AC/1s 5mA, (Multiple output: Sec.500V AC/1s 5mA)

Electrical parameters: (The following parameters are typical values and actual values will be subject to product testing)

Remarks:

Primary input voltage	110	220	380	V	Customizable other voltage inputs. example: Between 0 ~ 660 v
Primary input voltage range	± 10			%	Other input ranges can be ordered example: ± 20%
Power	1500			VA	Rated power
Voltage regulation	2			%	For reference only
No load loss	30			VA	For reference only
Weight	16			Kg	For reference only

Secondary output full load voltage Single	Secondary no-load voltage Single	Secondary full load current Single	1. Can be customized according to customer requirements output Voltage/current to each according to his need 2. If not specified, the secondary output is full load voltage (customized no-load). 3. Transformer input/output for communication Do the rectification notice 4. Other types can be customized tap pressure frequency shielding
110V	113.3V	13.6A	
220V	226.6V	6.81A	
380V	391.4V	3.94A	
—	—	—	

Standard product wiring schematic diagram:

Remarks:

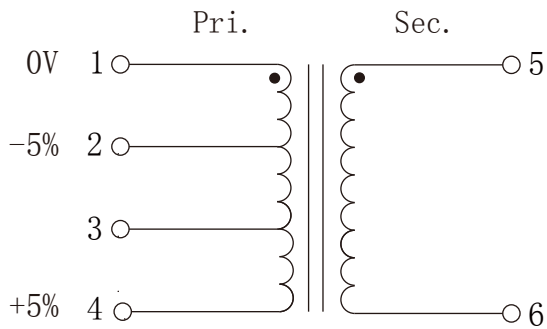

- Represents the same end
- No. 2 terminal is high pressure regulating tap
- Terminal 3 is rated input voltage
- No. 4 terminal is low pressure regulating tap

Dimensions (in mm ± 0.5) :

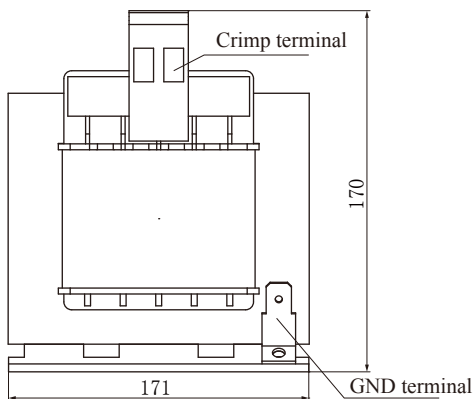

Front View

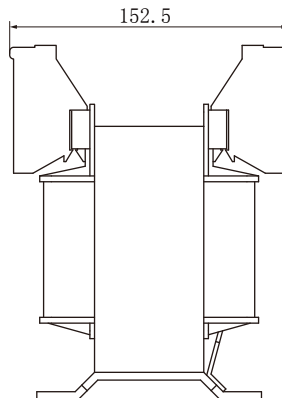

Side View

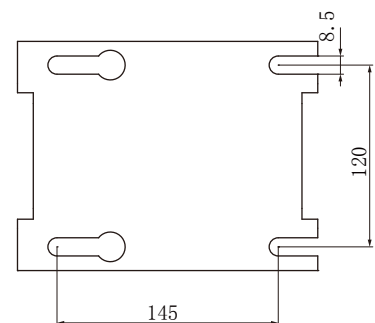

Bottom fixed diagram