

Hall voltage sensor

Din-rail installation, Crimping terminal output. Detect DC, AC and pulse current, High insulation between primary side and the vice side circuit.

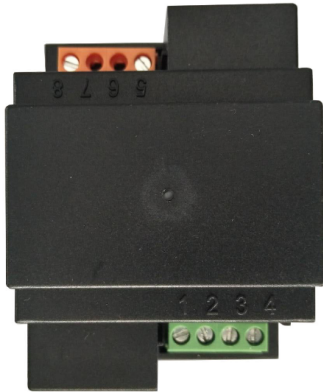

Front view

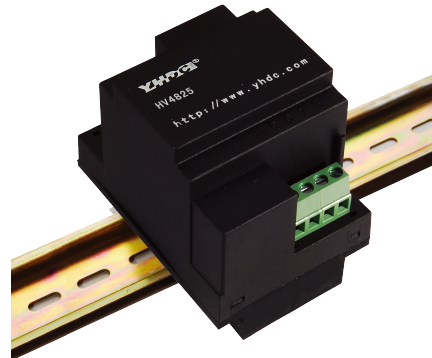

Bottom view

Product features

- Low power consumption
- Good linearity
- No insertion loss
- Fast response time
- Good anti-interference ability

Product application

- Railway
- Metallurgical
- Welding machine
- Robot
- Motor
- Inverter power supply
- Variable frequency governor
- Uninterrupted power supply and communication power supply

High side after wiring
Terminal proposal seal processing

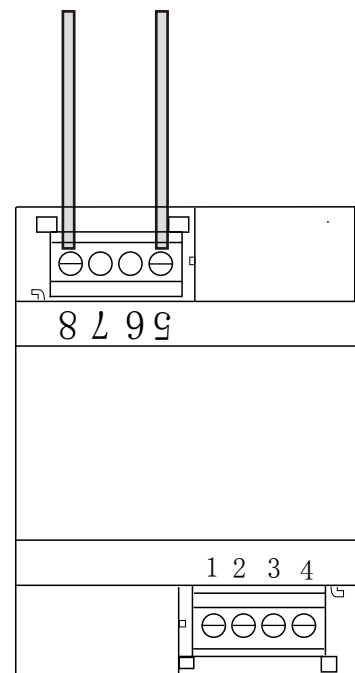

Electrical parameters: (The following parameters are typical values and actual values will be subject to product testing)

Remarks:

I_p	Rated input	$\pm 50V$	$\pm 100V$	$\pm 200V$	$\pm 300V$	$\pm 400V$	$\pm 500V$	Standard input
I_{pm}	Input measurement range	$\pm 70V$	$\pm 150V$	$\pm 300V$	$\pm 450V$	$\pm 600V$	$\pm 750V$	Default is 1.5 times of rated input
V_{out}	Rated output	$\pm 5V$						Standard output
X	Accuracy	1%						$I=I_p$
ϵ_L	Linearity	0.2%						$I=0 \sim \pm I_p$
V_c	Supply voltage	$\pm 12V / \pm 15V$						One or the other Supply voltage range $\pm 5\%$
I_c	Current consumption	$\leq \pm 15mA + I_s$						Reference will be subject to the measured
R_l	Load impedance	$\geq 10K \Omega$						Collection port impedance while lower voltage affect accuracy
V_{oe}	Zero offset voltage	$\leq \pm 30mV$						$T_A=25^\circ C$
T_r	Response time	$40 \sim 200 \mu s$						Reference will be subject to the measured
N_w	Weight	191g						Reference will be subject to the measured
T_a	Operation temperature	$-10 \sim +70^\circ C$						
T_s	Storage temperature	$-25 \sim +70^\circ C$						
B_w	Band width	-						Factory test according to DC
V_d	Delectric strength	3.5KV 50Hz 1min						

Instruction for use:

1. Correct wiring as indicated
2. Full scale measurement, response time and following the speed for the best
3. Faulty wiring can lead to product damage and output uncertainty

Safe operation:

- *Please read this specification carefully before use.
- *When you need to move the product, please be sure to disconnect the power and all the connected cables.
- *If found shell, devices attached to the fixed parts, wire, or have any damaged, please immediately deal with hidden dangers.
- *If there is any doubt about the safe operation of the equipment, the equipment and the corresponding accessories should be closed immediately, and the fastest time for troubleshooting.

Proclamations:

As our products are constantly being improved and updated, we reserve the right to modify the content of this specification at any time without prior notice.

Dimensions(in mm±0.5) :

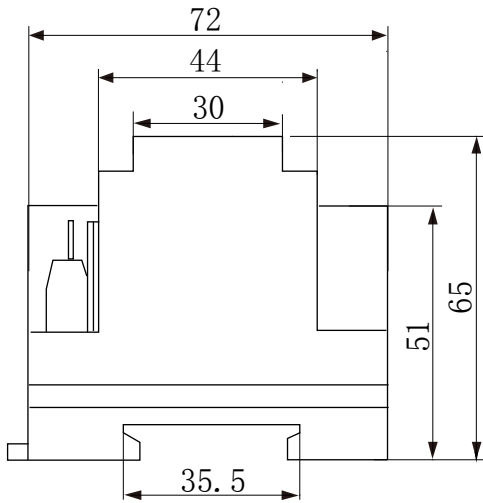

Front view

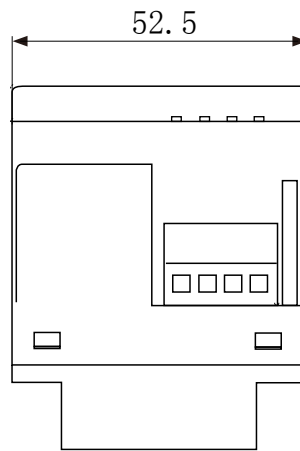

Side view

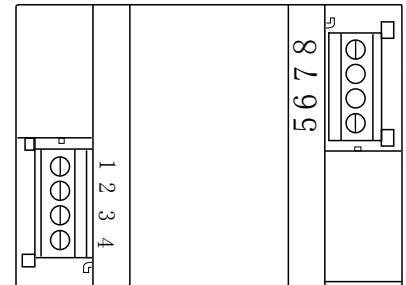

Top View

Wiring diagram:

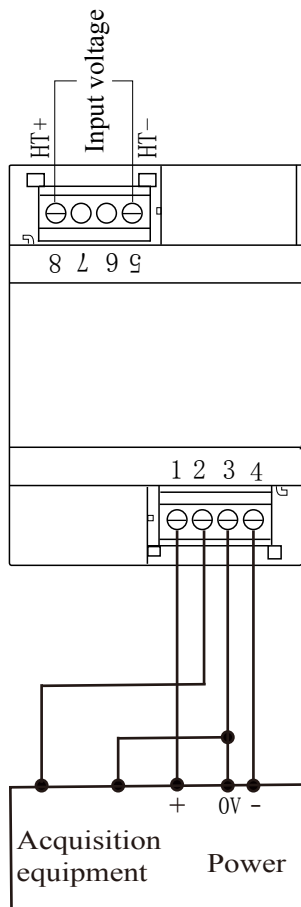

Terminal definition :

- 1: +V
- 2: Vout
- 3: 0V
- 4: -V
- 5: -HT
- 6: Air terminal
- 8: +HT
- 7: Air terminal

※ Detection :

- ① Choose the auxiliary power supply with small ripple ($\leq 10\text{mV}$)
- ② Switch on auxiliary power
- ③ The auxiliary power is connected to the sensor
- ④ The sensor detects the primary current