

Hall split core current sensor



Model: HSTS08L

Circular hole Suspended mounting, output with cable; Wrong connection will make the sensor bad, detection DC, AC, pulse current and primary detection current are linearly related to output, and the output signal can be directly entered into the automatic control equipment or PLC port



Technical Index:

Flame resistance: UL94-V0

Working temperature: $-25^{\circ}\text{C} \sim +70^{\circ}\text{C}$

Storage temperature: $-25^{\circ}\text{C} \sim +70^{\circ}\text{C}$

Dielectric strength: 2.5KV 50Hz 1min

Electrical parameters:

I_{PN}	Rated input	± 10	± 20	A
I_{PM}	Input measured range	± 10	± 20	A
V_{Out}	Rated output	2.5 ± 0.625		V
X	Accuracy	1		%
ϵ_L	Linearity	0.2		%
V_C	Supply voltage($\pm 5\%$)	+5		V
I_C	Current consumption	≤ 12	$\text{mA} + I_s$	
R_L	Load impedance	$\geq 10\text{K}$		Ω
I_{OE}	Zero offset TA= 25°C	$\leq \pm 15$		mV
T_R	Response time	≤ 1		μs
T_S	Band width	DC		
N.W	Weight	22		g

Connection diagram:

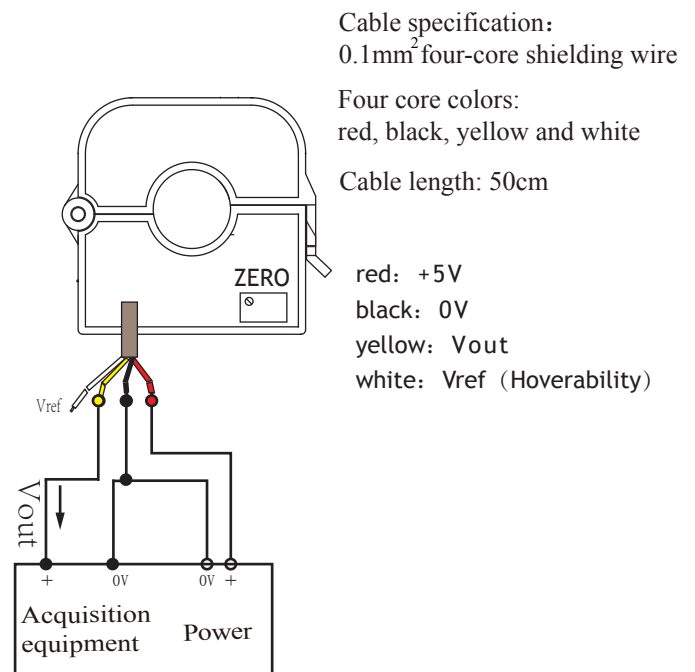

Dimensions (in mm ± 0.5) :

