

Hall split core current sensor

Open loop split core type, Sub-plate installation, terminal output. Detect DC, AC and pulse current, High insulation between primary side and the vice side circuit.

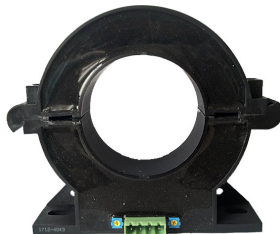

Front view



Back view



Fixed hole view

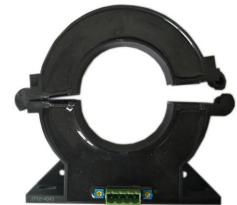

Opening view

Installation diagram

Product features

- Light weight
- Low power consumption
- Good linearity
- No insertion loss
- Fast response time
- Good anti-interference ability

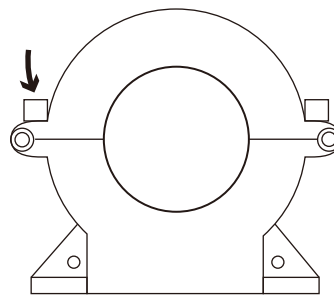

1. Loosen the screw

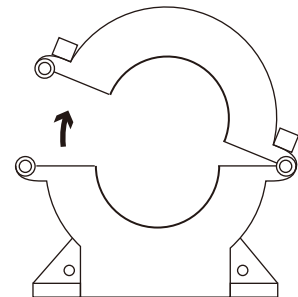

2. Open up

Product application

- Railway
- Metallurgical
- Welding machine
- Robot
- Motor
- Inverter power supply
- Variable frequency governor
- Uninterrupted power supply and communication power supply

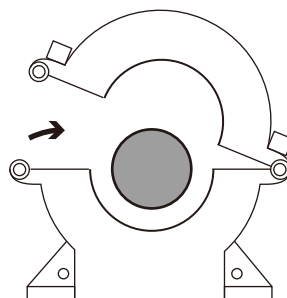

3. In the lead

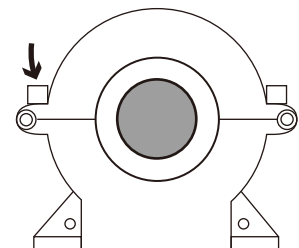

4. Tighten the screws

Electrical parameters: (The following parameters are typical values and actual values will be subject to product testing)

Remarks:

I _p	Rated input	±500A	±600A	±800A	±1000A	±1200A	±1500A	Standard input
I _{pm}	Input measurement range	±600A	±720A	±960A	±1200A	±1440A	±1800A	Default is 1.2 times of rated input
V _{out}	Rated output	2.5V ± 0.625V						Standard output
X	Accuracy	1%						I=I _p
ε _L	Linearity	1%						I=0 ~ ± I _p
V _c	Supply voltage	+5V						Supply voltage range±5%
I _c	Current consumption	≤ 16mA						Reference will be subject to the measured
R _l	Load impedance	≥ 10K Ω						Collection port impedance while lower voltage affect accuracy
V _{oe}	Zero offset voltage	≤ ± 15mV						T _A =25 °C
T _r	Response time	≤ 5 μ s						Reference will be subject to the measured
N.w	Weight	643g						Reference will be subject to the measured
T _a	Operation temperature	-10 ~ +70 °C						
T _s	Storage temperature	-25 ~ +70 °C						
Bw	Band width	DC ~ 10KHz						Factory test according to DC
V _d	Delectric strength	3KV 50Hz 1min						

Factory commissioning :

Calculation formula: 2.5V±0.625V 0V datum

1. Debugging with 0V as the reference point(acquiescence) Forward direction: $2.5 + (I/IP) * 0.625$
2. Debug with V_{ref} as the reference point(optional) Reverse direction: $2.5 - (I/IP) * 0.625$

Instructions for use:

1. According to the connection mode of correct connection
2. The direction shown by the arrow is positive
3. With hole measurement, response time and following the speed for the best
4. Faulty wiring can lead to product damage and output uncertainty

Safe operation:

- *Please read this specification carefully before use.
- *When you need to move the product, please be sure to disconnect the power and all the connected cables.
- *If found shell, devices attached to the fixed parts, wire, or have any damaged, please immediately deal with hidden dangers.
- *If there is any doubt about the safe operation of the equipment, the equipment and the corresponding accessories should be closed immediately, and the fastest time for troubleshooting.

Proclamations:

As our products are constantly being improved and updated, we reserve the right to modify the content of this specification at any time without prior notice.

Dimensions(in mm±0.5) :

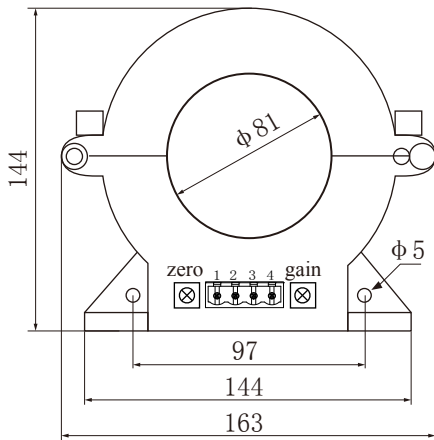

Front view

Current direction
positive ← Epoxy surface

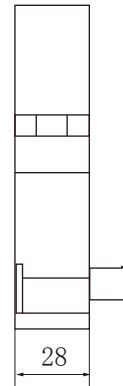

Side view

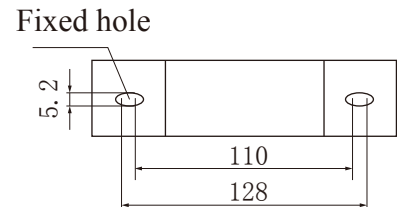

Bottom view

Connector Illustration

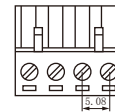

Wiring diagram (based on 0 V)

Crimping terminal fast plug 2EDG-5.08-4p spacing 5.08mm

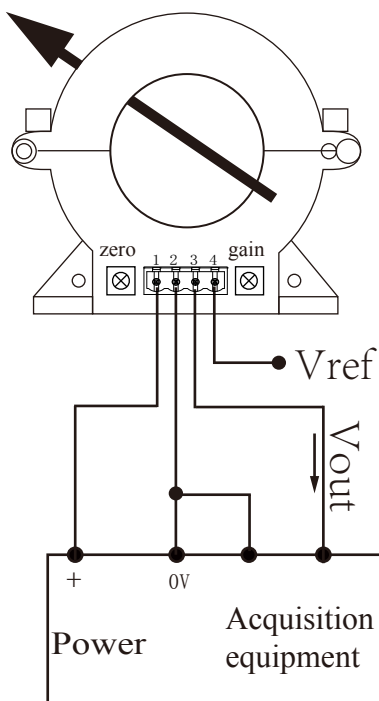

Terminal definition :

- 1: +5V
- 2: 0V
- 3: Vout
- 4: Vref (Can be suspended, not grounded)

Potentiometer definition :

- Left: zero
- right: gain

※ Detection :

- ① Choose the auxiliary power supply with small ripple ($\leq 10\text{mV}$)
- ② Switch on auxiliary power
- ③ The auxiliary power is connected to the sensor
- ④ The sensor detects the primary current