

Hall split core current sensor

Open loop split core type, Sub-plate installation, terminal output. Detect DC, AC and pulse current, High insulation between primary side and the vice side circuit.

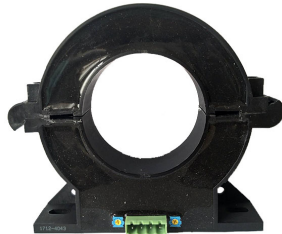

Front view



Back view



Fixed hole view

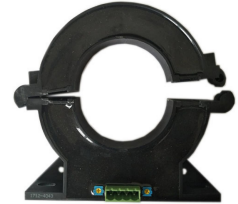

Opening view

Installation diagram

Product features

- Light weight
- Low power consumption
- Good linearity
- No insertion loss
- Fast response time
- Good anti-interference ability

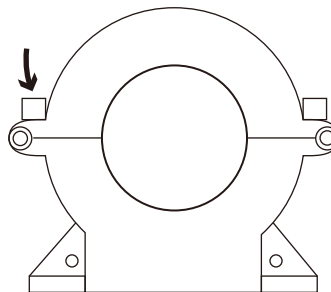

1. Loosen the screw

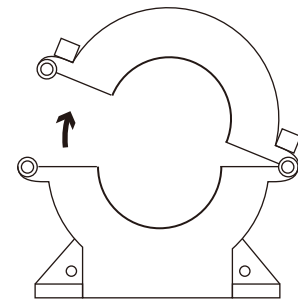

2. Open up

Product application

- Railway
- Metallurgical
- Welding machine
- Robot
- Motor
- Inverter power supply
- Variable frequency governor
- Uninterrupted power supply and communication power supply

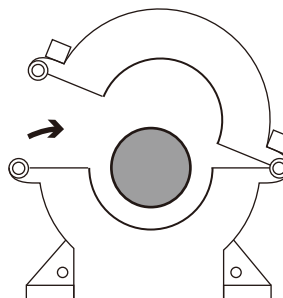

3. In the lead

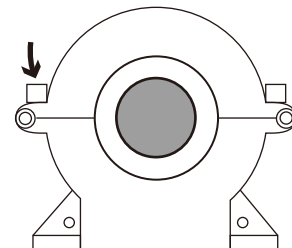

4. Tighten the screws

Electrical parameters: (The following parameters are typical values and actual values will be subject to product testing)

Remarks:

I_{PN}	Rated input	$\pm 300A$	$\pm 500A$	$\pm 800A$	$\pm 1000A$	$\pm 1200A$	$\pm 1500A$	Standard input
I_{pm}	Input measurement range	$\pm 360A$	$\pm 600A$	$\pm 960A$	$\pm 1200A$	$\pm 1440A$	$\pm 1800A$	Default is 1.2 times of rated input
V_{out}	Rated output	$\pm 4V$						Standard output
X	Accuracy	1%						$I=I_{PN}$
ϵL	Linearity	1%						$I=0 \sim \pm I_{PN}$
V_c	Supply voltage	$\pm 12V / \pm 15V$						One or the other Supply voltage range $\pm 5\%$
I_c	Current consumption	$\leq \pm 16mA$						Reference will be subject to the measured
Rl	Load impedance	$\geq 10K \Omega$						Collection port impedance while lower voltage affect accuracy
V_{oe}	Zero offset voltage	$\leq \pm 15mV$						$T_A=25^\circ C$
T_r	Response time	$\leq 5 \mu s$						Reference will be subject to the measured
N.w	Weight	542g						Reference will be subject to the measured
T_a	Operation temperature	$-10 \sim +70^\circ C$						
T_s	Storage temperature	$-25 \sim +70^\circ C$						
Bw	Band width	DC $\sim 10KHz$						Factory test according to DC
V_d	Dielectric strength	3KV 50Hz 1min						

Instructions for use:

1. According to the connection mode of correct connection
2. The direction shown by the arrow is positive
3. With hole measurement, response time and following the speed for the best
4. Faulty wiring can lead to product damage and output uncertainty

Safe operation:

- *Please read this specification carefully before use.
- *When you need to move the product, please be sure to disconnect the power and all the connected cables.
- *If found shell, devices attached to the fixed parts, wire, or have any damaged, please immediately deal with hidden dangers.
- *If there is any doubt about the safe operation of the equipment, the equipment and the corresponding accessories should be closed immediately, and the fastest time for troubleshooting.

Proclamations:

As our products are constantly being improved and updated, we reserve the right to modify the content of this specification at any time without prior notice.

Dimensions(in mm±0.5) :

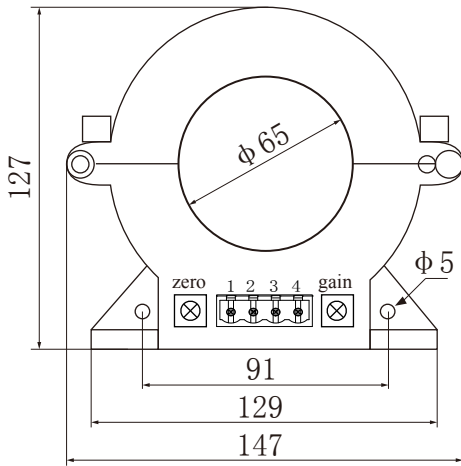

Front view

Current direction
Print surface ← Epoxy surface

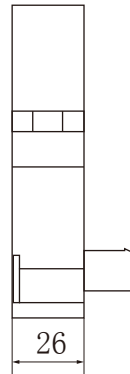

Side view

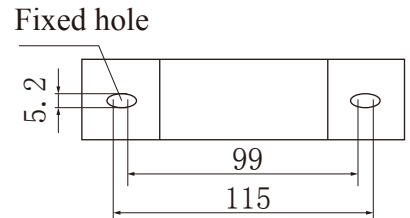

Bottom view

Connector Illustration

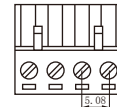

Crimping terminal fast plug 2EDG-5.08-4p spacing 5.08mm

Wiring diagram:

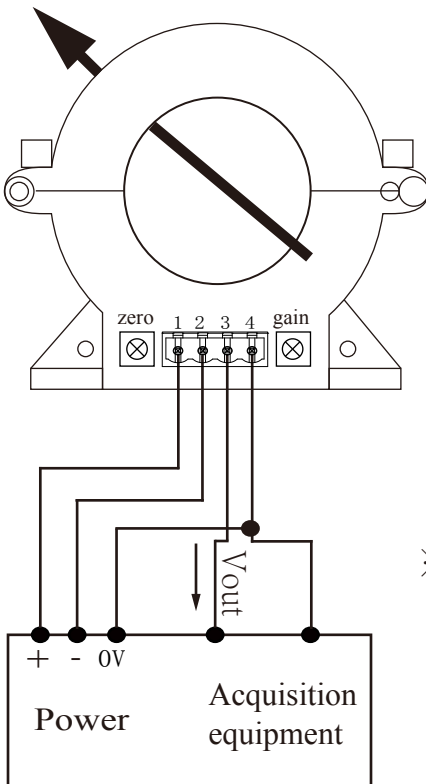

Terminal definition:

- 1 : +V
- 2 : -V
- 3 : Vout
- 4 : 0V

Potentiometer definition:

- Left: zero
- right: gain

※ **Detection:**

- ① Choose the auxiliary power supply with small ripple ($\leq 10\text{mV}$)
- ② Switch on auxiliary power
- ③ The auxiliary power is connected to the sensor
- ④ The sensor detects the primary current