

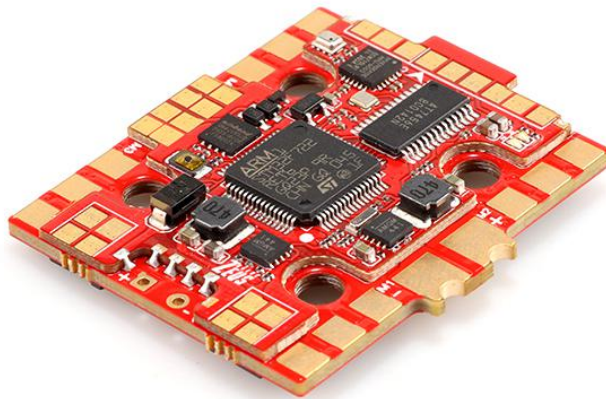

Zeus35 Pro AIO Flight Controller Manual



Contents

Product Specifications.....	1
Interface Description.....	2
Check the flight control drive.....	3
Calibration accelerometer.....	4
UART serial port use.....	5
Select aircraft model.....	6
Choose ESC protocol.....	7
Voltage and current parameters setting.....	8
Setting up the receiver.....	9
VTX serial port use. VTX uses OSD smart audio.....	10
GPS parameters setting.....	11
Check receiver signal.....	12
Select flight mode startup mode.....	13
OSD settings.....	14
LED settings.....	15
Troubleshooting.....	16

.....

Package Included

Zeus35 Pro AIO*1	Accessory Bag*1
------------------	-----------------

1. Product Specifications

Product parameters	
Model	Zeus35 Pro AIO
Weight	13.8g
Input Voltage	3-6S
Usage	for 100mm-450mm Frame Kit
Installing Hole	20x20mm/M3
Dimensions	40.0x34.0mm
FC Firmware	BF ZEUSF722_AIO(HGLR)
CPU	STM32F722
MPU	MPU6000
BEC	9V/1A 5/2A
BlackBox	8M
UARTS	5
ESC Firmware	BL_S
Current Sensor	not support
Constant Current	35A
Peak Current	40A (5s)

2. Interface Description

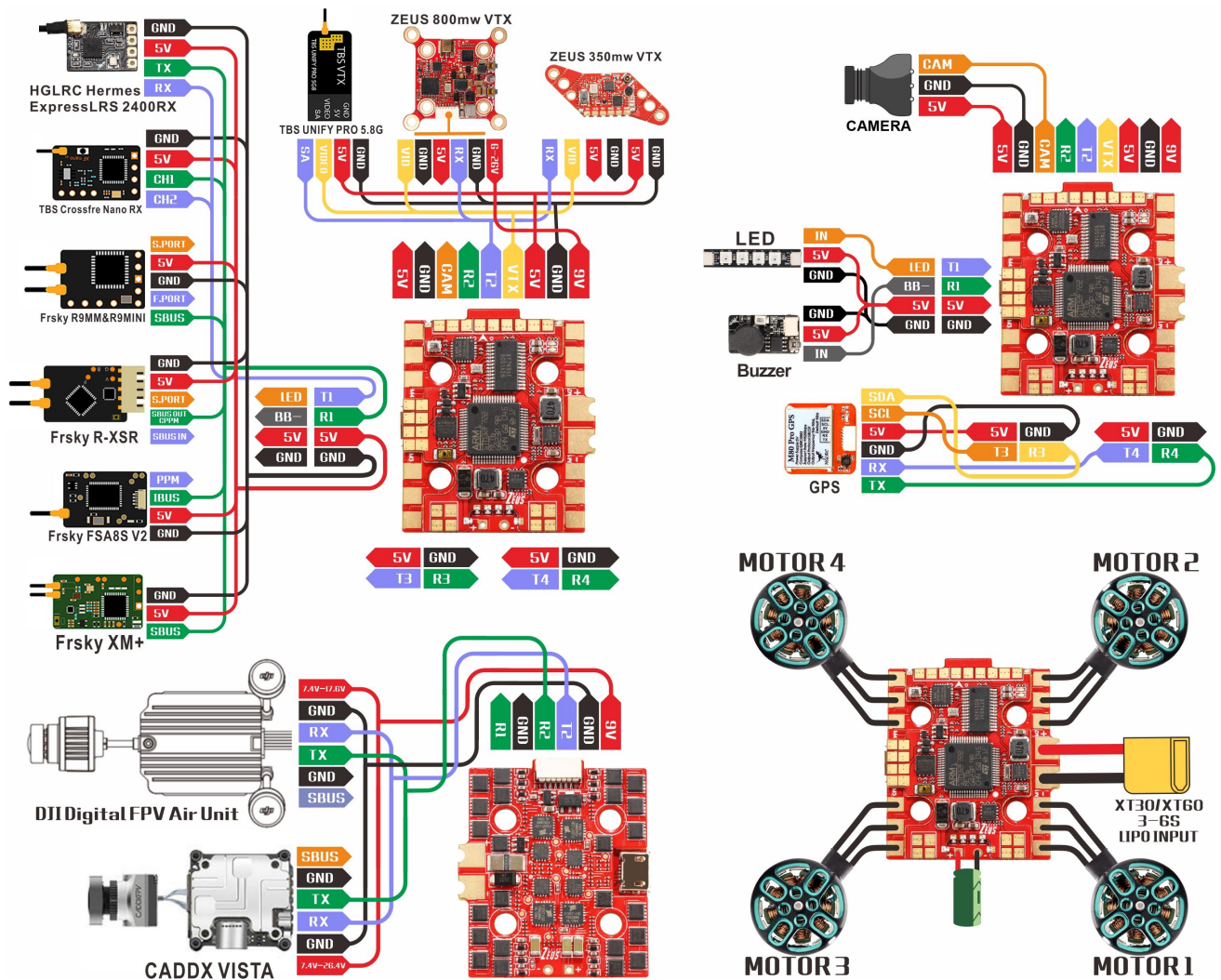

3. Check the flight control drive

1. Long Press BOOT buttons.connect USB.The system automatically install the driver



2.Driver cannot be installed, please download ImpulseRC_Driver_Fixer



3.Double-click on the run(Plug in the flight controller to automatically install the driver)

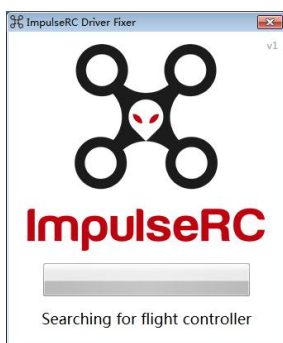

4.open betaflyght configurator , enter DFU mode

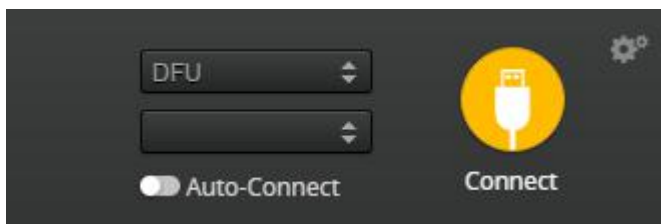

5.Click  Select firmware version

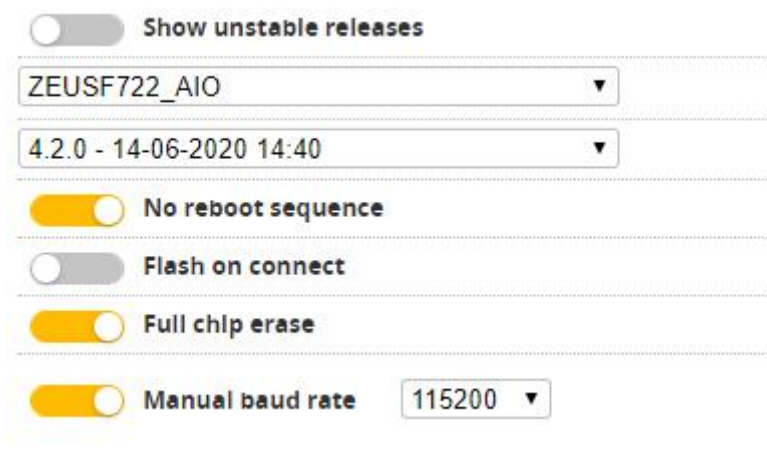

6. Click **Load Firmware [Online]** Load firmware. **Flash Firmware** Waiting for completion **Erasing ...** It will be prompted upon completion. **Programming: SUCCESSFUL**

7. open betaflyght configurator . Controller plugged into the computer. Betaflight Automatically assigned port, click "Connect" Enter setup interface (Different computer COM)

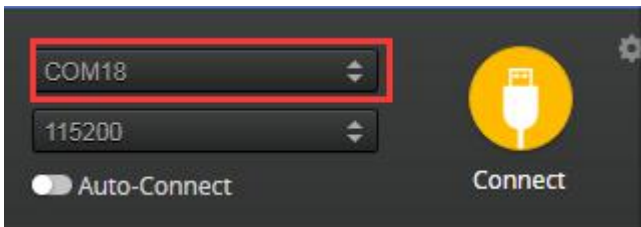

4. Calibration accelerometer

1. Put the aircraft horizontal and click “Reset Z axis”

Click again 

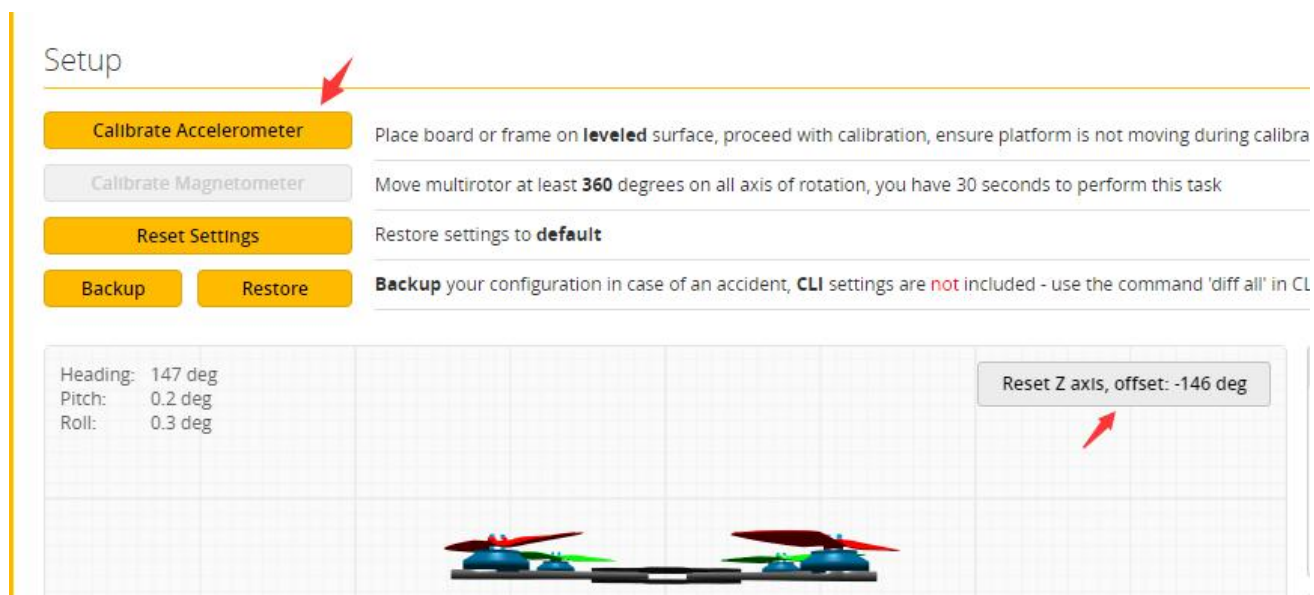

5. UART serial port use

1. UART1 uses the receiver

2. UART2 uses VTX/DJI

3. UART3

4. UART4 uses GPS

5. UART6

6. Select aircraft model

1. Click **Configuration** Select model

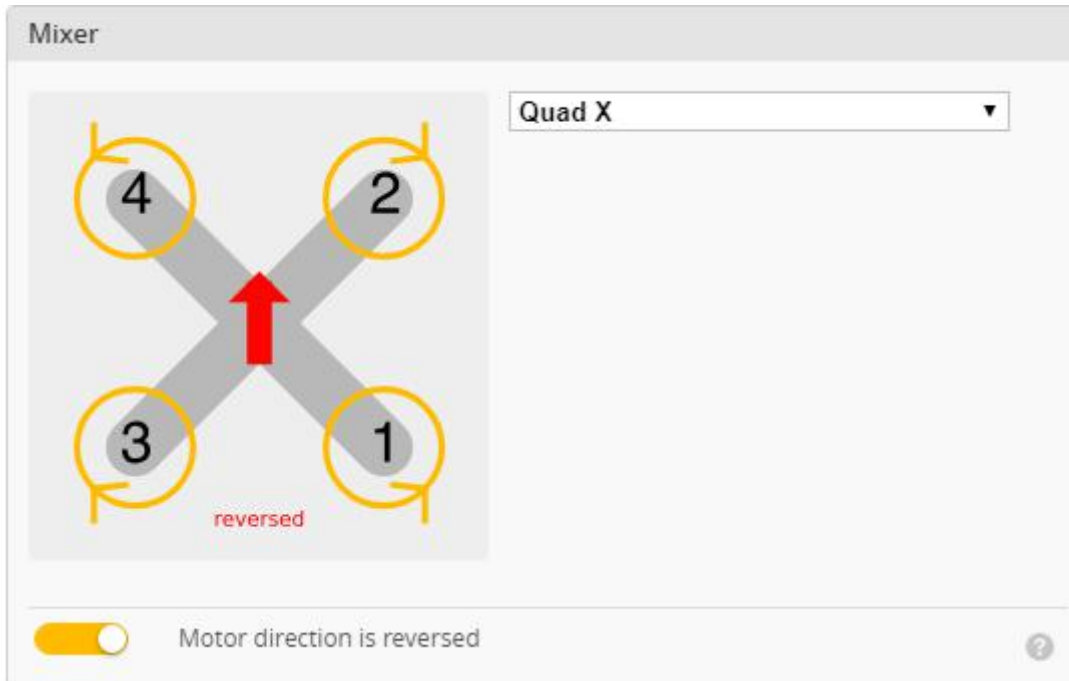

2. Click **Motors** Click “**I understand the risks**” Push Master to check motor steering “**Master**” Steering can be changed at [BLHeliSuite32](#)

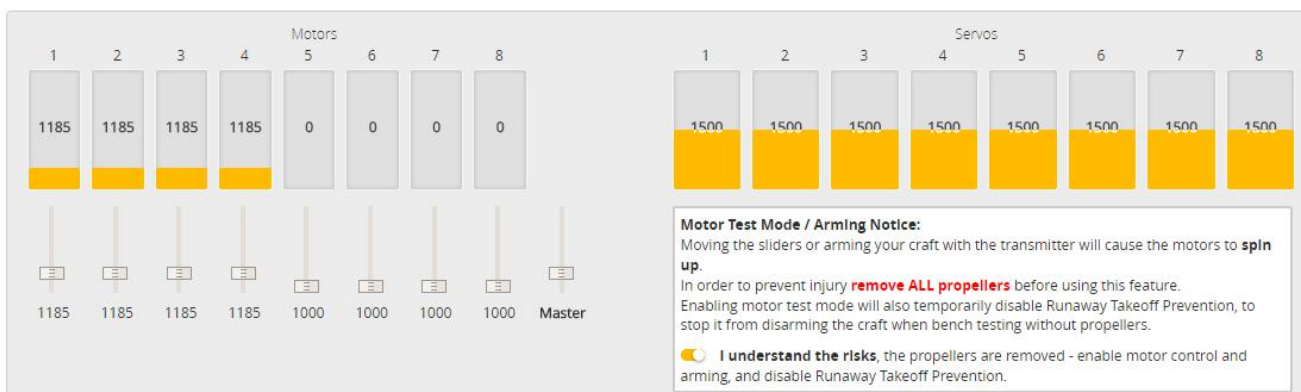

7. Choose ESC protocol

1. Choose the right ESC protocol, the optional universal protocol DSHOT600.

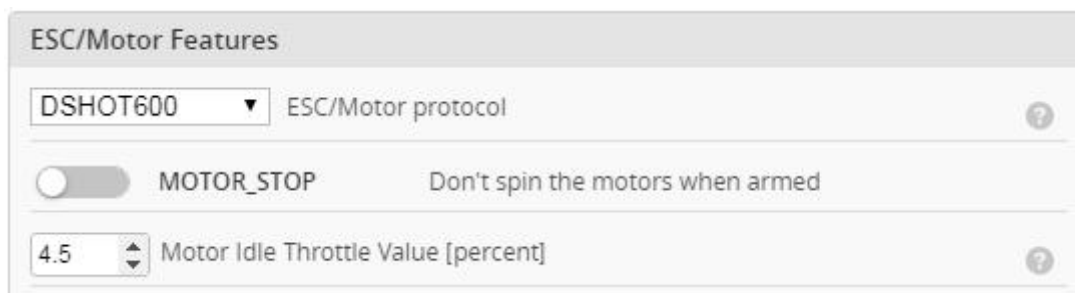

ESC/Motor Features

DSHOT600 ESC/Motor protocol

MOTOR_STOP Don't spin the motors when armed

4.5 Motor Idle Throttle Value [percent]

8. Voltage and current parameters setting

1. Click **Power & Battery** Setting parameters

Power & Battery

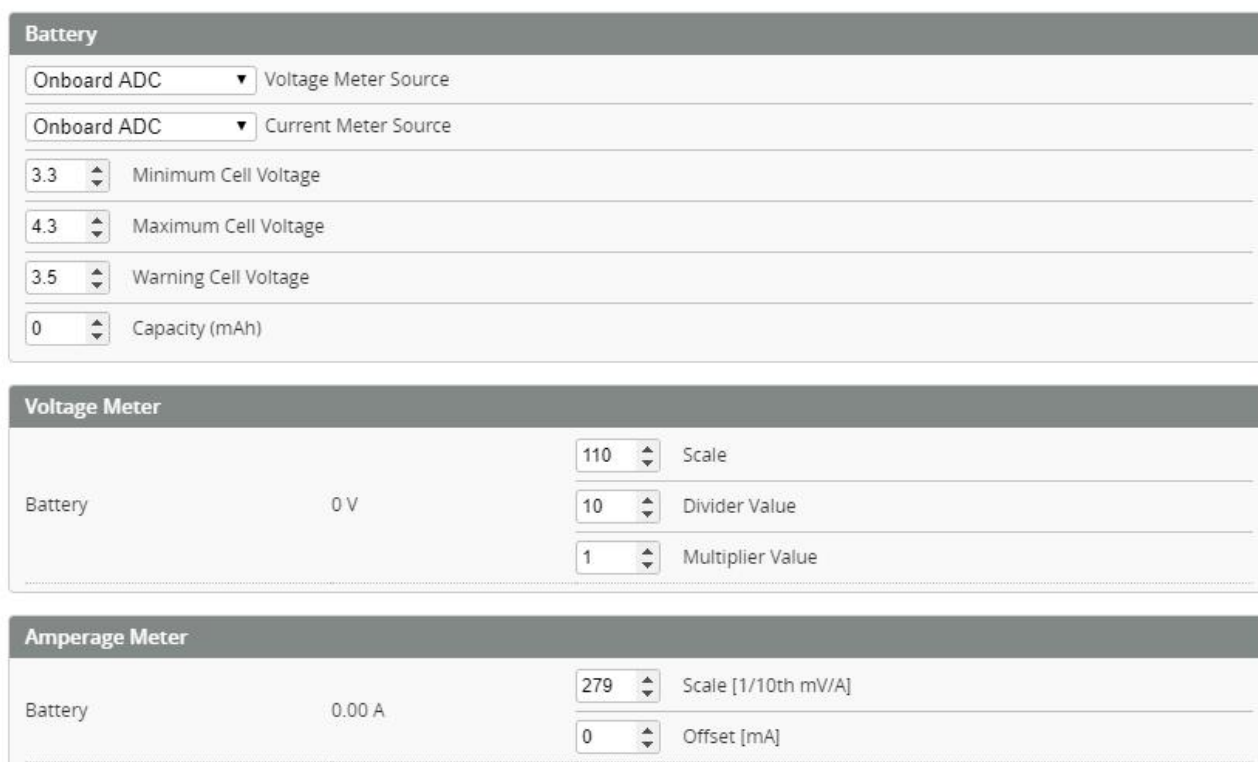

Battery

Onboard ADC Voltage Meter Source

Onboard ADC Current Meter Source

3.3 Minimum Cell Voltage

4.3 Maximum Cell Voltage

3.5 Warning Cell Voltage

0 Capacity (mAh)

Voltage Meter

Battery 0 V

110 Scale

10 Divider Value

1 Multiplier Value

Amperage Meter

Battery 0.00 A

279 Scale [1/10th mV/A]

0 Offset [mA]

9. Setting up the receiver

1. Receiver connection diagram

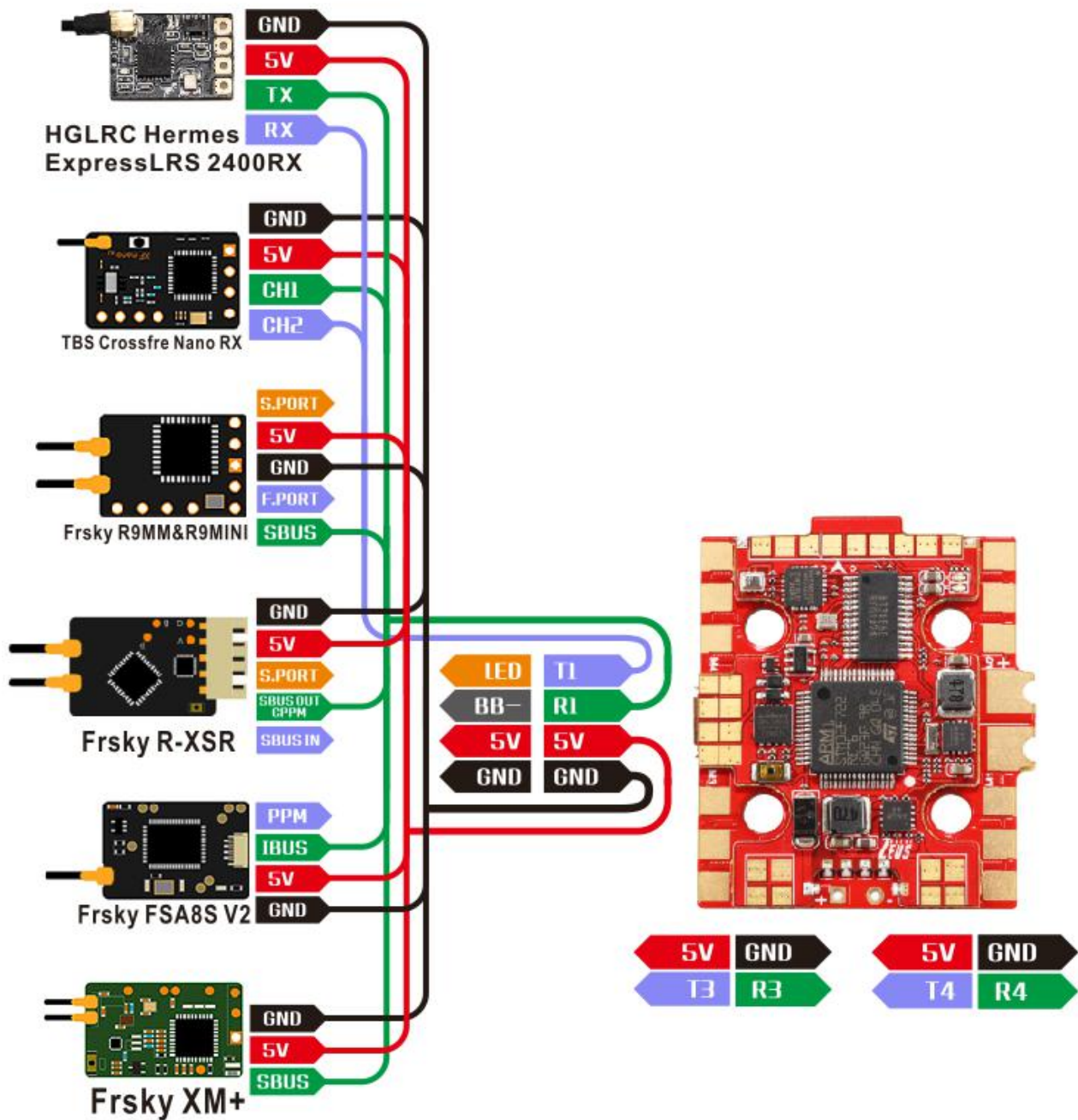

2. DJI FPV Air Unit wiring

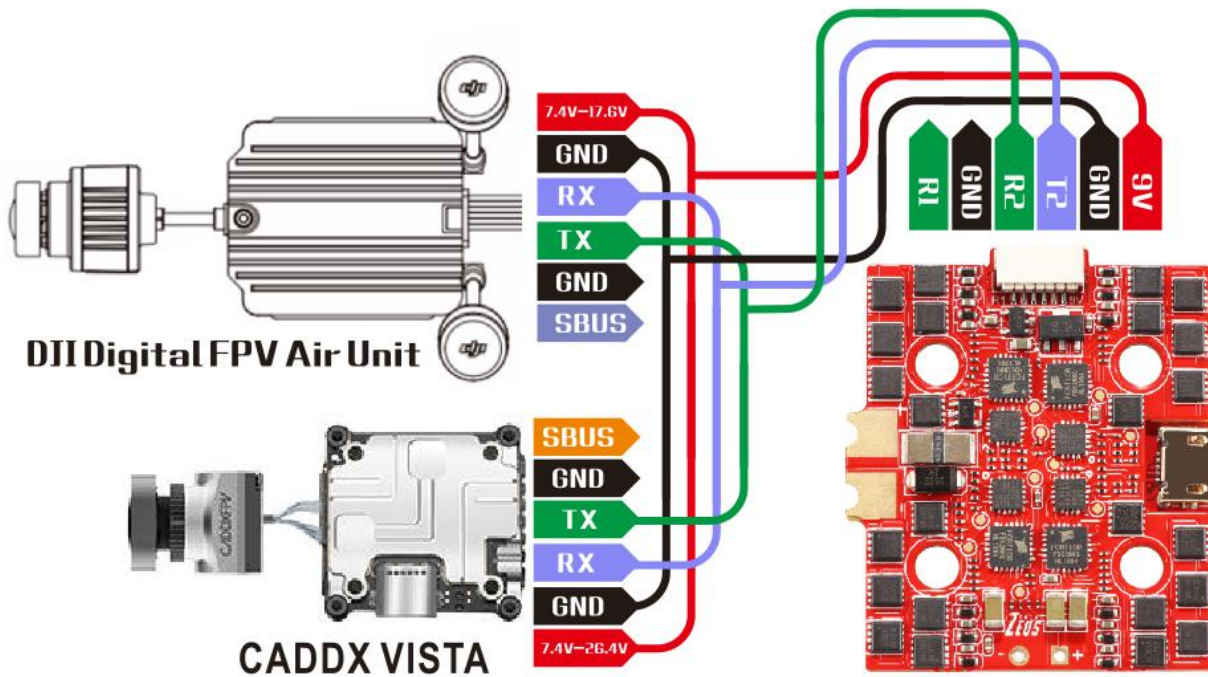

3. VTX serial port opens. The protocol is selected according to its own VTX protocol.

Identifier	Configuration/MSP	Serial Rx	Telemetry Output	Sensor Input	Peripherals
USB VCP	<input checked="" type="checkbox"/> 115200	<input type="checkbox"/>	Disabled AUTO	Disabled AUTO	Disabled AUTO
UART1	<input type="checkbox"/> 115200	<input checked="" type="checkbox"/>	Disabled AUTO	Disabled AUTO	Disabled AUTO
UART2	<input type="checkbox"/> 115200	<input type="checkbox"/>	Disabled AUTO	Disabled AUTO	VTX (IRC Tran AUTO
UART3	<input type="checkbox"/> 115200	<input type="checkbox"/>	Disabled AUTO	Disabled AUTO	Disabled AUTO
UART4	<input type="checkbox"/> 115200	<input type="checkbox"/>	Disabled AUTO	Disabled AUTO	Disabled AUTO
UART6	<input type="checkbox"/> 115200	<input type="checkbox"/>	Disabled AUTO	ESC AUTO	Disabled AUTO

4. DJI serial port opens

Identifier	Configuration/MSP	Serial Rx	Telemetry Output	Sensor Input	Peripherals
USB VCP	<input checked="" type="checkbox"/> 115200	<input type="checkbox"/>	Disabled AUTO	Disabled AUTO	Disabled AUTO
UART1	<input type="checkbox"/> 115200	<input checked="" type="checkbox"/>	Disabled AUTO	Disabled AUTO	Disabled AUTO
UART2	<input checked="" type="checkbox"/> 115200	<input type="checkbox"/>	Disabled AUTO	Disabled AUTO	Disabled AUTO
UART3	<input type="checkbox"/> 115200	<input type="checkbox"/>	Disabled AUTO	Disabled AUTO	Disabled AUTO
UART4	<input type="checkbox"/> 115200	<input type="checkbox"/>	Disabled AUTO	Disabled AUTO	Disabled AUTO
UART6	<input type="checkbox"/> 115200	<input type="checkbox"/>	Disabled AUTO	ESC AUTO	Disabled AUTO

5. Use OSD to adjust VTX

which displays information like battery voltage and mAh consumed while you fly. In addition, the Betaflight OSD can be used to configure the quadcopter, making in-field adjustments and tuning more convenient.

MODE2

MODE1

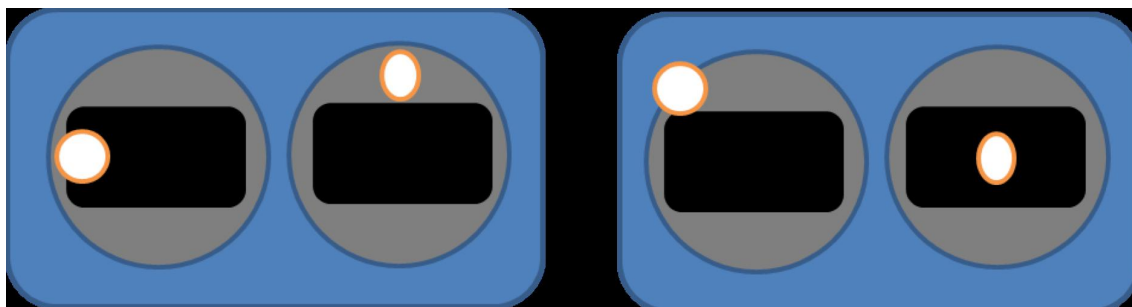

The graphics above show the stick command to bring up the OSD menu. The stick command is: throttle centered, yaw left, pitch forward. The exact stick command therefore depends on which mode your transmitter sticks are in.

In the OSD menu, use pitch up/down to move the cursor between menu items. When a menu option has a > symbol to the right of it, this indicates that it contains a sub-menu.

Roll-right will enter the sub-menu. For example, in the screen to the right, moving the cursor to “Features” and then moving the roll stick to the right will enter the “Features” sub-menu.

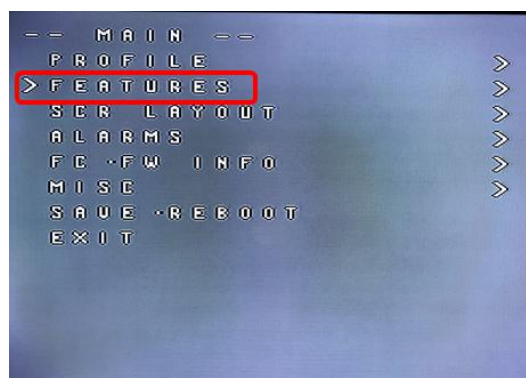

If you are using a video transmitter that supports remote configuration, enter the “Features” menu to configure the vTX. From there, enter either “VTX SA” if you are using SmartAudio (TBS Unify) or “VTX TR” if you are using IRC Tramp Telemetry.

To adjust PIDs, rates, and other tuning-related parameters, enter the “Profile” sub-menu.

In the “Scr Layout” sub-menu, you can move the OSD elements (like battery voltage, mAh, and so forth) around on the screen.

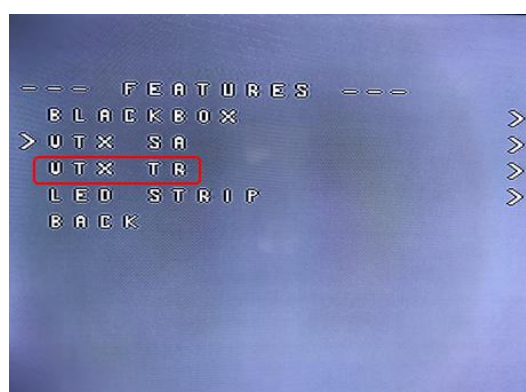

The “Alarms” sub-menu lets you control when the OSD will try to alert you that battery voltage is too low or mAh consumed is too high.

When a parameter can be modified, the parameter's current value will be shown on the right-hand side of the screen. In this case, roll left/right will adjust the parameter up and down.

The screen to the right shows the current vTX settings. From here, you can change the frequency band, channel, and power level of the video transmitter. After making the changes, move the cursor to "Set" and press roll-right to confirm the settings.

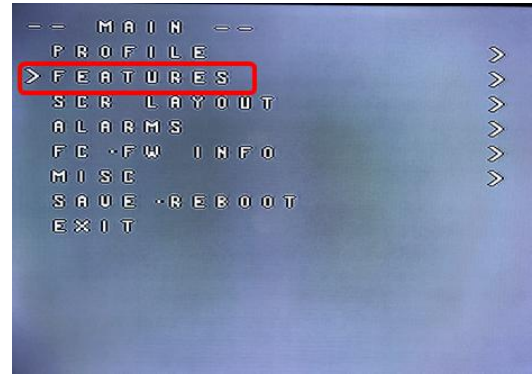

11. GPS parameters setting

1. GPS connection diagram

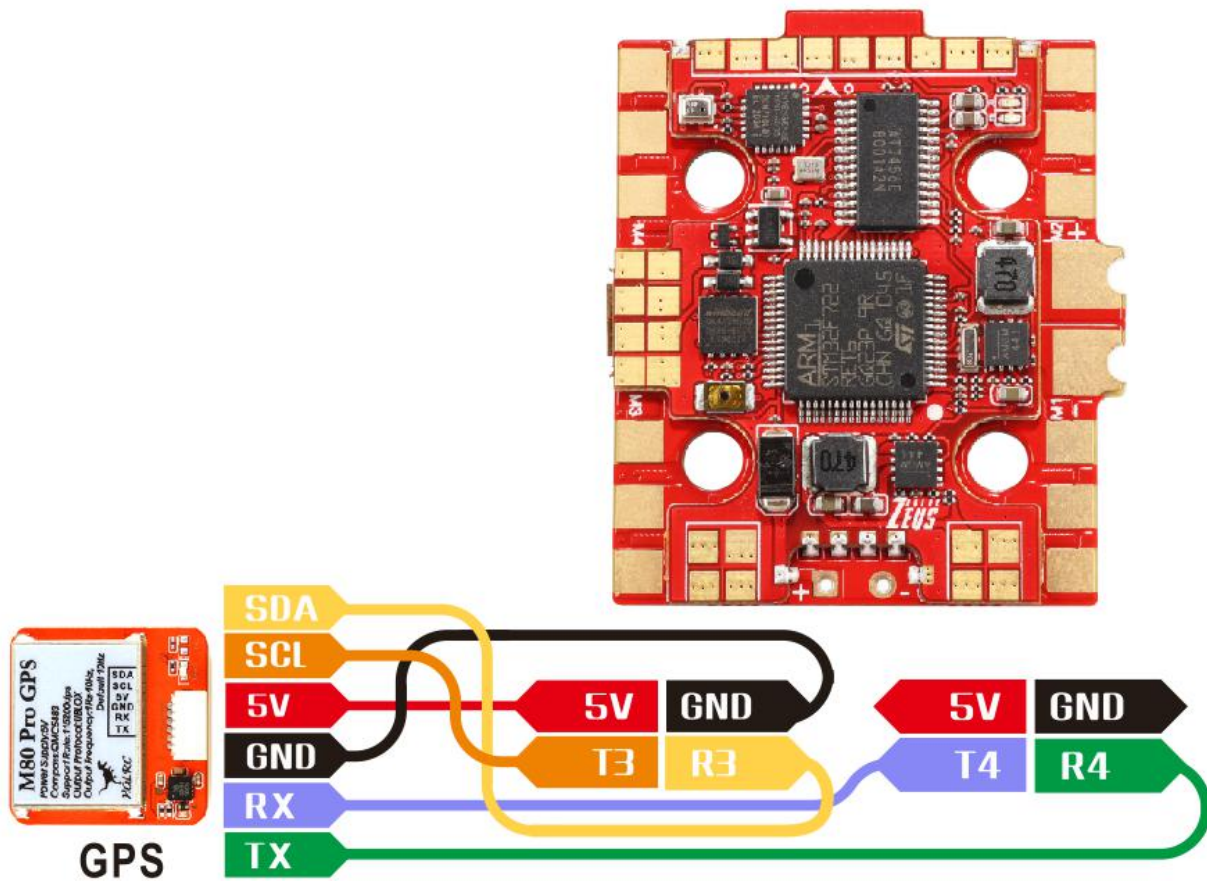

2. Open the GPS serial port

Ports

WIKI

Note: not all combinations are valid. When the flight controller firmware detects this serial port configuration will be reset.
Note: Do **NOT** disable MSP on the first serial port unless you know what you are doing. You may have to reflash and erase your configuration if you do.

Identifier	Configuration/MSP	Serial Rx	Telemetry Output	Sensor Input	Peripherals
USB VCP	<input checked="" type="checkbox"/> 115200 ▼	<input type="checkbox"/>	Disabled ▼ AUTO ▼	Disabled ▼ AUTO ▼	Disabled ▼ AUTO ▼
UART1	<input type="checkbox"/> 115200 ▼	<input checked="" type="checkbox"/>	Disabled ▼ AUTO ▼	Disabled ▼ AUTO ▼	Disabled ▼ AUTO ▼
UART2	<input type="checkbox"/> 115200 ▼	<input type="checkbox"/>	Disabled ▼ AUTO ▼	Disabled ▼ AUTO ▼	Disabled ▼ AUTO ▼
UART3	<input type="checkbox"/> 57600 ▼	<input type="checkbox"/>	Disabled ▼ AUTO ▼	Disabled ▼ AUTO ▼	Disabled ▼ AUTO ▼
UART4	<input type="checkbox"/> 115200 ▼	<input type="checkbox"/>	Disabled ▼ AUTO ▼	GPS ▼ 115200 ▼	Disabled ▼ AUTO ▼
UART6	<input type="checkbox"/> 115200 ▼	<input type="checkbox"/>	Disabled ▼ AUTO ▼	Disabled ▼ AUTO ▼	Disabled ▼ AUTO ▼

3. When using the GPS function, remember to configure the serial port (via the Ports tab).

GPS

GPS GPS for navigation and telemetry ?

Note: Remember to configure a Serial Port (via Ports tab) when using GPS feature.

UBLOX ▼ Protocol

Auto Baud

Auto Config

Auto-detect ▼ Ground Assistance Type

0.00 ▲▼ Magnetometer Declination [deg]

12. Check receiver signal

1. Click  Receiver Check the remote control output signal

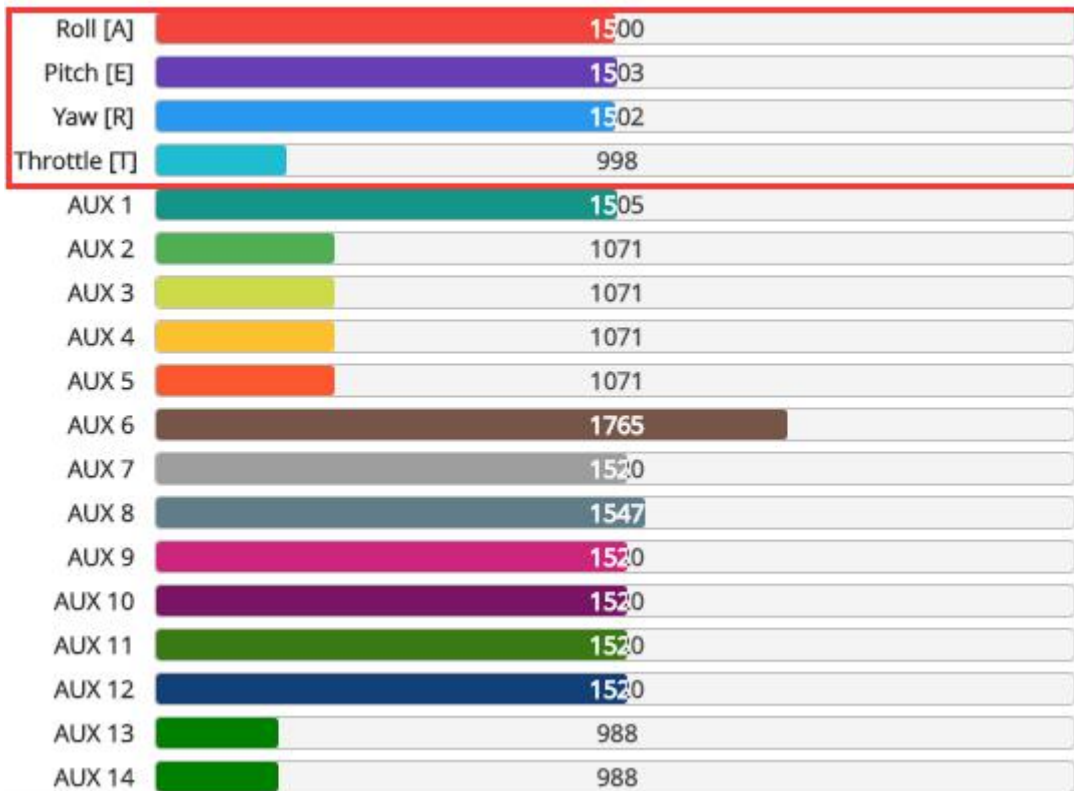

13. Select flight mode startup mode

1. Click  Modes set up the function of remote control switch across the channel (below are for reference only)

Modes WIKI

Use ranges to define the switches on your transmitter and corresponding mode assignments. A receiver channel that gives a reading between a range min/max will activate the mode. Remember to save your settings using the Save button.

Show/hide unused modes

ARM	AUX 1	Min: 1300 Max: 2100	900 1000 1200 1400 1500 1600 1800 2000 2100
ANGLE	AUX 1	Min: 1300 Max: 2100	900 1000 1200 1400 1500 1600 1800 2000 2100

14.OSD settings

1. Click  the OSD Settings, according to the need to choose, drag the OSD schematic diagram of the parameters can be adjusted.



The screenshot displays the OSD settings interface, which is divided into several sections:

- Elements:** A list of 15 items with toggle switches. The "Main Batt Voltage" item is currently selected and highlighted in yellow. The other items are: Rssi Value, Crosshairs, Artificial Horizon, Horizon Sidebars, Timer 1, Timer 2, Flymode, Craft Name, Throttle Position, Vtx Channel, Current Draw, Mah Drawn, and Gps Speed.
- Preview (drag to change position):** A central window showing a live video feed of a drone in flight. The text "BETAFLIGHT" is overlaid in the upper center, and "LOW VOLTAGE" is overlaid in the lower center. A battery icon in the bottom left corner shows a level of 16. A "Logo" toggle switch is visible in the top right corner of this window.
- Video Format:** Radio buttons for "AUTO" (selected), "PAL", and "NTSC".
- Units:** Radio buttons for "IMPERIAL" and "METRIC" (selected).
- Timers:** Two timer configurations:
 - 1. Source: ON TIME (dropdown), Precision: SECOND (dropdown), Alarm: 10 (spin box).
 - 2. Source: TOTAL ARMED TIME (dropdown), Precision: SECOND (dropdown), Alarm: 10 (spin box).

15.LED settings

1. Click  Configuration Turn on LED support



2. Click  LED Strip .Click  set according to need

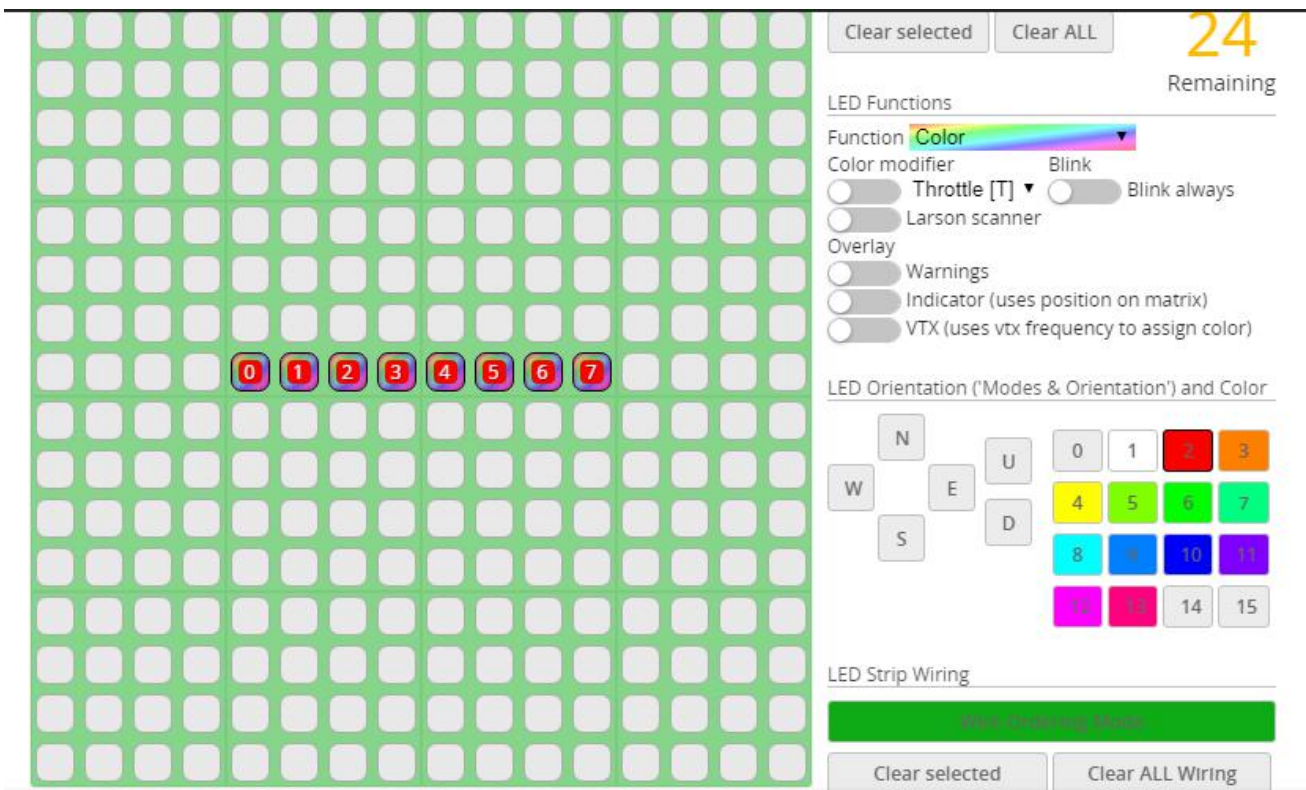

Clear selected Clear ALL **24** Remaining

LED Functions
Function **Color**
Color modifier Blink
 Throttle [T] Blink always
 Larson scanner
Overlay
 Warnings
 Indicator (uses position on matrix)
 VTX (uses vtx frequency to assign color)

LED Orientation ('Modes & Orientation') and Color

N	U	0	1	2	3
W	E	4	5	6	7
S	D	8	9	10	11
		12	13	14	15

LED Strip Wiring
Wire Ordering Mode

Clear selected Clear ALL Wiring

16. Troubleshooting

Warning:

Please read the cautions as follows, otherwise stability of your flight controller cannot be ensured, your flight controller will even get damaged.

- Keep focus on the polarity. Check carefully before power supply.
- Cut off the power when you connect, plug and pull anything.
- The refresh rate of PID and Gyroscope is up to 8K/8K.

after sales question:

1. After receiving the goods, it is found that the product can not be used normally. If the return to the factory is a quality problem, the repair service will be provided free of charge.
2. If the product is damaged due to improper operation, the repair service may be provided under the condition that the inspection can be repaired.
3. For domestic customers, please contact the after-sales service personnel. For overseas customers, please contact the official website for after-sales service.

Product daily problems

1.OSD garbled:

If you find garbled characters, please open Betaflight, click "OSD" .and click "Font Manager" clicks on "Upload Font" to update

1. When plugged in the battery, the aircraft does not pass the self-test without "BBB" sound. There is only one sound.

Please check if the ESC agreement is correct

3.The spin of the aircraft keeps spinning

1. Please check if the propeller is correct
2. Please check if the motor direction is correct