

USER MANUAL

**ELECTRIC
LOG SET**

ETERNAL FLAME
EF23-SERIES

IMPORTANT SAFEGUARDS

READ ALL INSTRUCTIONS BEFORE USE.

WARNING!

FAILURE TO FOLLOW INSTRUCTIONS MAY
LEAD TO DAMAGE OF THE MACHINE OR
PERSONAL INJURY.

RETAIN THIS MANUAL FOR
FUTURE REFERENCE

TURBRO

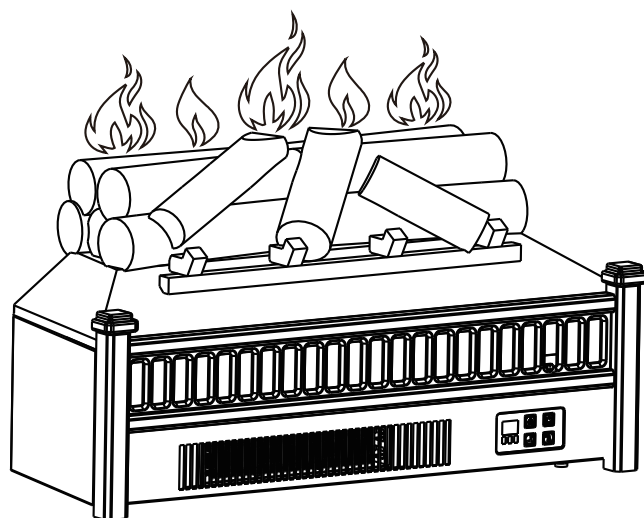

Contents

C o n t e n t s	01
S a f e t y I n f o r m a t i o n	02
P r e - i n s t a l l a t i o n	04
I n s t a l l a t i o n	05
O p e r a t i o n	06
F C C / I C I n f o r m a t i o n	10
T r o u b l e s h o o t i n g	11
W a r r a n t y	12

WARNING

Any attempt to disassemble or modify the product may cause damage.

When using this fireplace for the first time, or after a long period of storage, let the fireplace run for at least 15 minutes with the thermostat set at “maximum” to remove the “new product” smell. This is because the fireplace absorbs moisture, creating an odor similar to that of old leather.

Safety Information

Please read all instructions before attempting to assemble, operate or install the product.

- Do not use this fireplace with missing, damaged, or broken legs.
- Do not use outdoors.
- This fireplace is not intended for use in bathrooms, laundry areas, and similar indoor locations. Do not place this appliance where it may fall into a bathtub or other water containers.
- This appliance is hot when in use. To avoid burns, do not touch surfaces with bare skin. If necessary, use handles when moving the fireplace. Keep combustible materials, such as furniture, pillows, bedding, papers, clothes and curtains at least 3 ft. (914 mm) from the appliance.
- Do not use this fireplace in elevated locations, such as on shelves, raised platforms, etc.
- Do not run the cord under carpeting. Do not cover the cord with throw rugs, runners and the like. Arrange the cord away from high traffic areas so that they will not be tripped over.
- Extreme caution is necessary when the fireplace is used by or near children or invalids and whenever the fireplace is left operating unattended.
- Do not operate the fireplace with a damaged cord or plug or after the appliance malfunctions, or is damaged. Any repairs to this appliance should be carried out by a qualified service person.
- Under no circumstances should this appliance be modified.
- Connect to properly grounded outlets only.
- Always plug the fireplace directly into a wall outlet/receptacle. An extension cord or relocatable power tap, (outlet/power strip), should never be used.
- This appliance, when installed, must be electrically grounded in accordance with local codes (For Canada: CSA C22.1 Canadian Electrical codes, For USA: National Electric Code, ANSI/NFPA No. 70).
- To disconnect this appliance, turn the fireplace off, then remove the plug from the outlet.
- Always unplug the fireplace if you do not plan to use it for a long period of time.
- Do not insert or allow foreign objects to enter any ventilation or exhaust opening, as this may cause an electric shock, fire, or damage to the appliance.
- To prevent possible fires, do not block air intakes or exhausts in any manner. Do not use on soft surfaces, like a bed, where openings may become blocked.
- The fireplace has hot, sparking, and arcing parts inside. Do not use it in areas where gasoline, paint, or flammable liquids are used or stored. This appliance should not be used as a drying rack for clothing.
- Use this appliance only as described in this manual. Any other use not recommended by the manufacturer may cause fire, electric shock, or personal injury.

Safety Information



DANGER



ELECTRICAL SAFETY
(High Voltage Appliance)



ELECTRICAL CONNECTION

A 15-Amp, 120-Volt, 60 Hz circuit with a properly grounded outlet is required. Preferably, the item will be on a dedicated circuit. Having other appliances on the same circuit may cause the circuit breaker to trip or the fuse to blow when the fireplace is in operation. The unit comes standard with a 6 ft. (1.8 m) long three wire cord, which can be found on the right side of the appliance.



Electrical outlet wiring must comply with local building codes and other applicable regulations to reduce the risk of fire, electrical shock and personal injury.



Do not use this item if any part of it has been under water. Immediately call a qualified service technician to inspect the item and replace any part of the electrical system which has been under water.

US-3Pin POLARIZED PLUG

This product is equipped with a 3-pin polarized plug as shown Fig.1. Connect to properly grounded outlets only. This unit is for use on 120 volts only. For your safety, please always plug the unit into a wall outlet/ receptacle. An extension cord or relocatable power tap (outlet/power strip) should never be used.

Fig.1

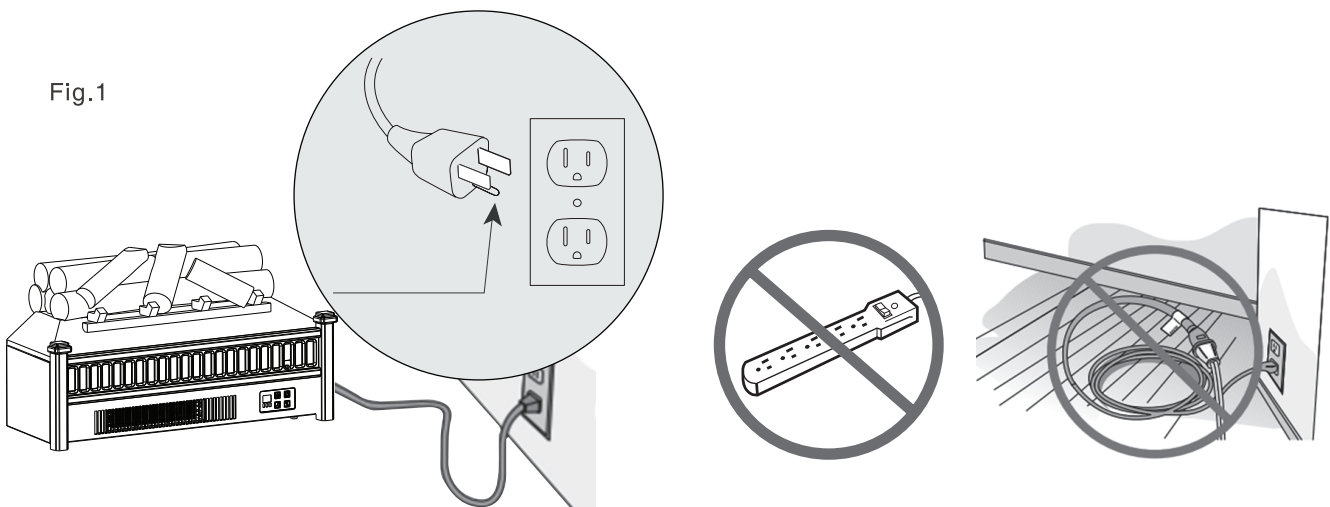

Pre-Installation

DIMENSIONS

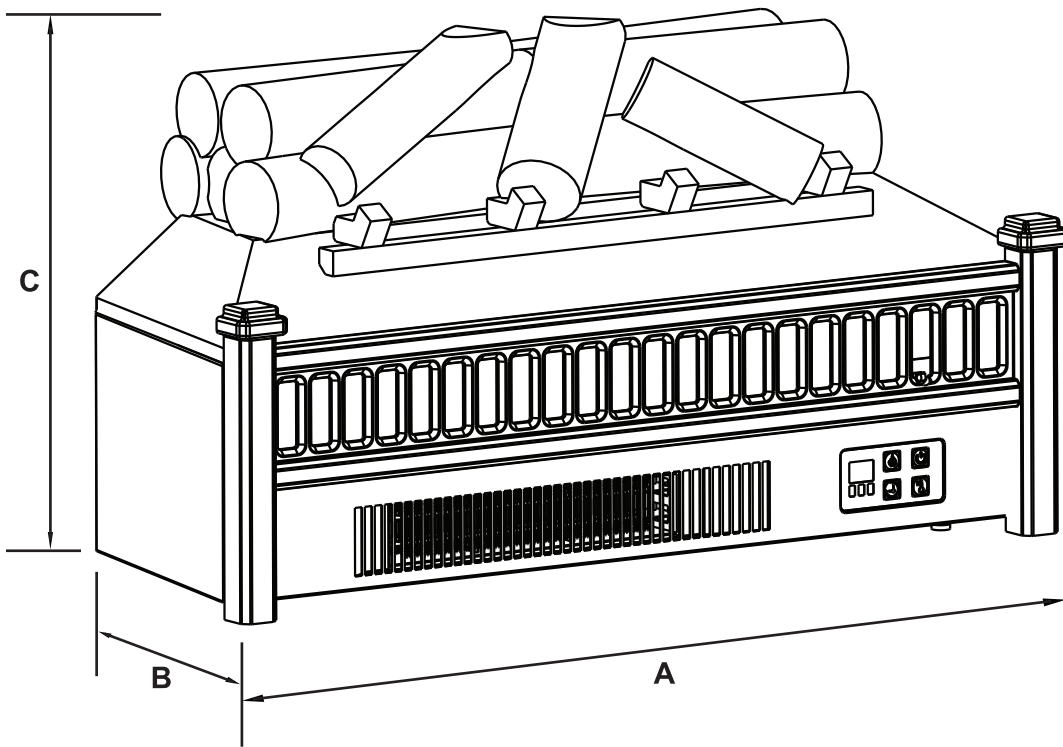

Remote control

A 23 in. (58.5 cm)

B 9 in. (23 cm)

C 12 in. (30.5 cm)

Technical Specifications

Voltage 120V AC

Frequency 60HZ

Amps 11.7A

Rating 1400W

Installation

The fireplace should be located in an area:

- Out of direct sunlight
- Not susceptible to moisture
- Away from uninsulated outside wall



WARNING

- The fireplace is heavy and contains glass, you need to move it carefully to prevent injury.



WARNING

- Do not install the unit on shelves, raised platforms, beds, blankets, pillows etc. Keep combustible materials such as furniture, bedding, papers, clothes and curtains at least 3 ft. (1m) from the fireplace.



CAUTION

- Make sure that the unit is installed so that the power cord is not compressed against or caught on the fireplace and that it has an unobstructed path to the grounded outlet.

Operation

Using the Control Panel

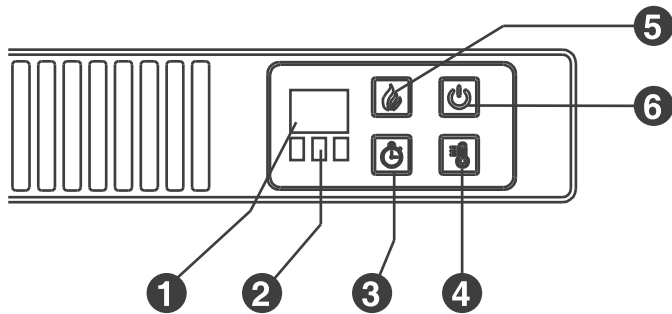

- 1 LCD Screen
- 2 Indicators
- 3 Timer
- 4 Heater ON/OFF
- 5 Flame control
- 6 Main power

- Press the Main Power Button **6** once to turn on the fireplace.

The flame effect will be on automatically. To enter the heating mode, please press the Heater ON / OFF Button **4**.

● Understanding the function indicator

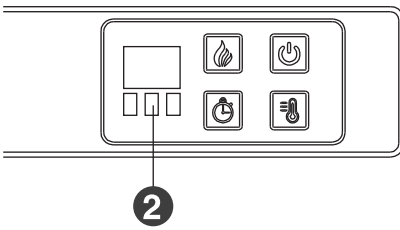

There are three LED indicators below the LCD screen – red, green, and blue. Red LED indicates the unit of the current displaying temperature value is Fahrenheit. Green LED indicates the unit of the current displaying temperature value is Celsius. Blue LED indicates the timer function is engaged.

● Using the heater control

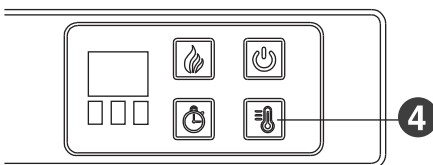

1. Press the Heater ON / OFF Button **4** to turn on the heater.
2. When the heater is on, long press the heater button for 5 seconds to enter the temperature setting mode. In this case, the LED indicator **2** is red, and the LCD Screen **1** flashes.
3. For temperature settings, see below table for detailed instructions.
4. When temperature setting finished, the LCD Screen **1** will flash five times and exit from the setting status.

NOTE:

- Heating will be automatically paused when the set temperature is reached.
- When setting the temperature with 'ON', the heater will work continuously until you turn it off manually.

Operation

● Change the Temperature Scale

Button Press	Fahrenheit Temperature
1	22°C
2	23°C
3	24°C
...	...
6	27°C
7	ON
8	17°C
9	18°C
...	...
12	21°C

Button Press	Fahrenheit Temperature
1	72°F
2	73°F
3	74°F
...	...
11	82°F
12	ON
13	62°F
14	63°F
...	...
22	71°F

1. With the heater on and the temperature is displaying with Fahrenheit scale, the indicator is red.
2. Gently press and hold the Main Power Button (6) for 5 a seconds to enter the temperature scale converting mode.
3. The LED indicator flashes 5 times in red, then changes to green. And the temperature value is displaying with Celsius scale.
4. Repeat the same process to convert from Celsius scale to Fahrenheit scale.

● Using the flame control

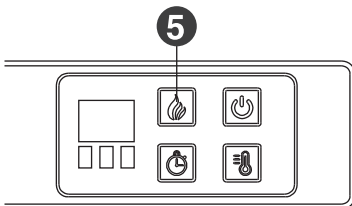

Press the Flame Control Button **5** to adjust the brightness of the flame effect. For flame brightness settings, see below table for detailed instructions.

Button Press	Flame Level	Display Value	Fireplace Appearance
1st press	High	L3	Flames Highest, Logs Glow Highest
2nd press	Medium	L2	Flames Medium, Logs Glow Medium
3rd press	Low	L1	Flames Low, Logs Glow Low

If you turn off the fireplace by press the Main Power Button **6** directly. The flame brightness setting won't be memorized. When the power is turned back on, the flame effect will come on in L3 mode (High) in default.

Operation

● Using the timer function

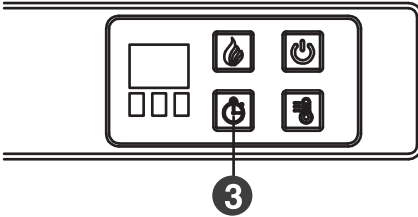

The Timer Button **3** controls both the flames and the heater function.

- If the heater is operating when the timer is set, then the heater is under the control of the timer.
- If the flame function is operating when the timer is set, then the timer will control the flame.
- If both the heater and flames are operating with the timer set, then the timer controls both the flames and the heater.

Press the Timer Button **3** to choose the time interval. The interval period is shown in the LCD Screen **1** and the indicator is in blue.

For timer settings, see below table for detailed instructions

Button Press	Timer Interval	Display
1st press	30 Minutes	30
2nd press	1 Hour	1h
3rd press	2 Hours	2h
4th press	3 Hours	3h
5th press	4 Hours	4h
6th press	5 Hours	5h
7th press	6 Hours	6h
8th press	OFF	None



Temperature Limiting Control

This fireplace is equipped with a Temperature Limiting Control. Should the fireplace reach an unsafe temperature because of misuse or accident, the fireplace will automatically turn off.

To reset: Unplug the power cord from the outlet. Wait for 10-20 minutes. And plug the power cord back into the outlet.

Operation

USE REMOTE CONTROL

The remote control is working within 13ft (4meters) away from the heater (without obstacles between the remote control and the fireplace)

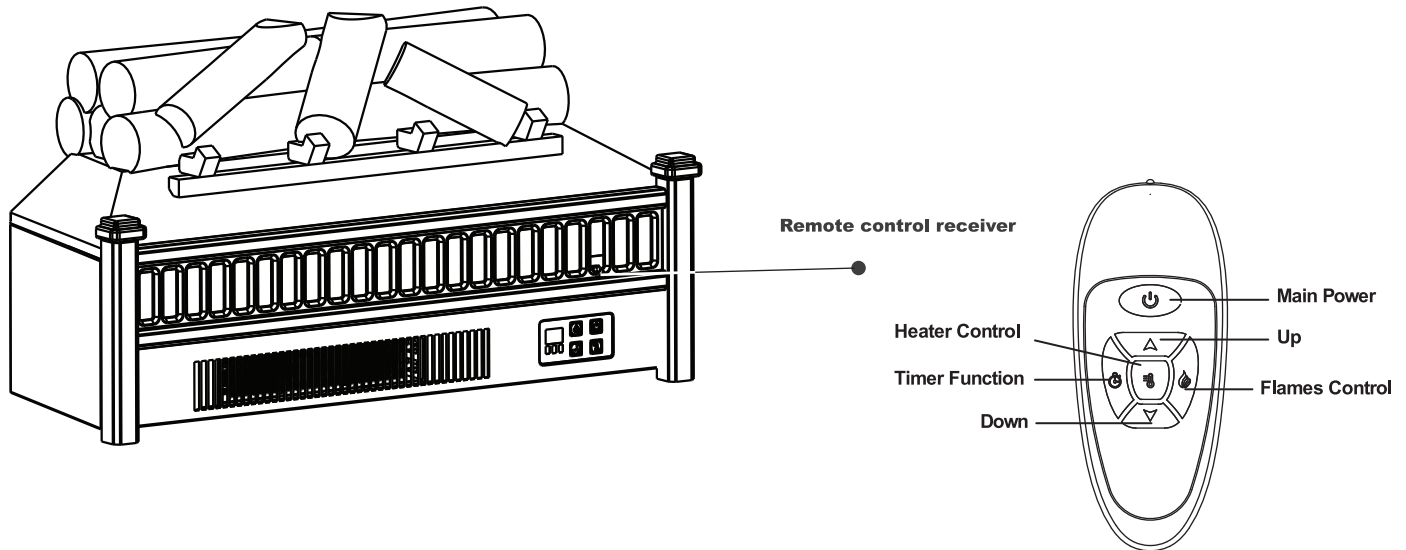

● INSERTING BATTERIES IN THE REMOTE

Press and glide the battery cover on the rear of the remote, remove the cover. Insert two new R03 "AAA" 1.5V batteries into the battery compartment. Make sure the polarity is correct.

Battery is not included in the package because of transportation safety.



CAUTION: Do not mix old and new batteries. Do not mix alkaline, standard (carbon-zinc), or rechargeable (ni-cad, ni-mh, etc) batteries.

Maintenance

- Always turn the fireplace OFF and unplug the power cord from the outlet before cleaning.
- Use a vacuum or duster to remove dust and dirt from the fireplace and vent areas.
- To keep luster, clean with a soft, slightly damp cloth and buff with a dry cloth.
- Never use abrasive cleansers, liquid sprays, or any cleaner that could scratch the surface of the appliance.

FCC/IC Information

Warning: Changes or modifications to this unit not expressly approved by the party responsible for compliance could void user's authority to operate the equipment.

NOTE: This equipment has been tested and found to comply with the limits for Class B digital device, pursuant to part 15 of the FCC Rules. These limits are designed to provide reasonable protection against harmful interference in a residential installation.

This equipment generates, uses, and can radiate radio frequency energy and, if not installed and used in accordance with the instructions, may cause harmful interference to radio communications.

However, there is no guarantee that interference will not occur in a particular installation. If this equipment does cause harmful interference to radio or television reception, which can be determined by turning the equipment off and on, the user is encouraged to try to correct the interference by one or more of the following measures:

- Reorient or relocate the receiving antenna
- Increase the separation between the equipment and the receiver.
- Connect the equipment into an outlet on a circuit different from that to which the receiver is connected.
- Consult the dealer or an experienced radio/TV technician for help.

This device complies with Part 15 of the FCC Rules. Operation is subject to the following two conditions:

- (1) This device may not cause harmful interference, and
- (2) This device must accept any interference received, including interference that may cause undesired operation.

Modifications not approved by the party responsible for compliance could void user's authority to operate the equipment.

This Class B digital apparatus complies with Canadian ICES-003.

Troubleshooting



WARNING

Disconnect power before servicing.

Problem	Possible Cause	Corrective Action
The fireplace does not operate.	<ul style="list-style-type: none"> • The fireplace is not plugged in. • A circuit breaker is tripped or a fuse blown. • The ON/OFF switch is defective. • There is loose wiring. 	<ul style="list-style-type: none"> • Make sure the fireplace is plugged in to a standard 120V outlet. • Check additional appliances on the circuit; ideally the fireplace should be on a dedicated 15-amp circuit. • Contact customer service. • Contact customer service.
The power light is ON but the flame effect is not visible.	<ul style="list-style-type: none"> • The fireplace is not operating correctly. 	<ul style="list-style-type: none"> • Contact customer service.
The fireplace is not operating.	<ul style="list-style-type: none"> • The fireplace is not operating correctly. • The fireplace switch is defective. • The fireplace assembly is defective. • There is loose wiring. • The vents are dirty or clogged. 	<ul style="list-style-type: none"> • Refer to the operating instructions. • Contact customer service. • Contact customer service. • Contact customer service. • Unplug the unit. Clear the vent area of dust and debris. Wait ten minutes, plug the unit in again and turn on the fireplace.
There is excessive noise when the fireplace is operating.	<ul style="list-style-type: none"> • The fan is defective. • The fireplace assembly is defective. 	<ul style="list-style-type: none"> • Contact customer service. • Contact customer service.

Warranty

1-YEAR WARRANTY

TURBRO provides 1-year limited warranty for TURBRO ETERNAL FLAME Logset, from the date of purchase, subject to the following conditions and limitations.

What is covered?

- Any alteration misuse of the product will nullify this warranty.
- This warranty is non-transferrable, which is effective for the original buyer from the authorized seller only.
- This warranty is limited to the repair or replacement of part(s) proved to be defective in material or workmanship, after said defect is confirmed by the manufacturer's inspection.

The manufacturer may, at its discretion, fully discharge all obligations with respect to this warranty by refunding the wholesale price of the defective part(s)

What's NOT covered?

- Damage caused by the owner when attempting to fix or alter the product themselves.
- Damage caused by misuse, abuse, neglect, alterations, or unauthorized repair.
- Natural depreciation.

How to request warranty services?

To obtain the benefit of this warranty, please leave a message online (<https://www.turbro.com/contact>), or send an email to support@turbro.com. Our customer service will address your issue within 24 hours.

What will TURBRO do?

- Repair the item.
- Replace the item if not repairable.
- Refund the item under certain circumstances.

ALL EXPRESSED AND IMPLIED WARRANTIES, INCLUDING THE WARRANTY OF MERCHANTABILITY, ARE LIMITED TO THE PERIOD OF THE LIMITED WARRANTY.



CAUTION

- This product can expose you to toxic chemicals including Di (2-ethylhexyl) phthalate (DEHP), which may cause cancer or harm developmental growth.
- Wash hands after installation.

For more information go to www.p65Warnings.ca.gov



TURBRO



© 2020 Katmai Technology Limited

support@turbro.com

www.turbro.com

