

Hykolity LED UFO High Bay Light

INSTALLATION INSTRUCTIONS

- Thank you for purchasing our UFO Highbay. Please read the below articles carefully to see how to use this product safely.
- Warning contents and attention contents related to product safety use, please be sure to follow it.

⚠ Warning

- This UFO High bay within the input voltage range: AC100-277V , 50/60Hz.
- If input voltage exceeds this range, it may cause tube failure. Please be sure to operate under correct input voltage.
- Ensure ambient operating temperature of -22°F(-30°C)through 122°F(50°C) .
- Using this UFO High bay in temperatures outside of this range will reduce the UFO High bay lifespan.
- Make sure to turn off power before starting the installation process.

⚠ Attention

- IP rating: IP65, can work under wet locations.
- Please keep the UFO High bay away from any corrosive substance. When you clean it, please use damp or dry cloth.

Model	KLHB150WCD	KLHB200WCD
Power	150W	200W
Input Current	1.65A	2.2A
Input Voltage	AC100-277V	
Frequency	50/60Hz	

Thoroughly inspect the fixture for freight damage. Freight damage should be reported to the delivery carrier.

The Installation must be carried out by a qualified electrician.

Installation Instruction

1. Hook type:

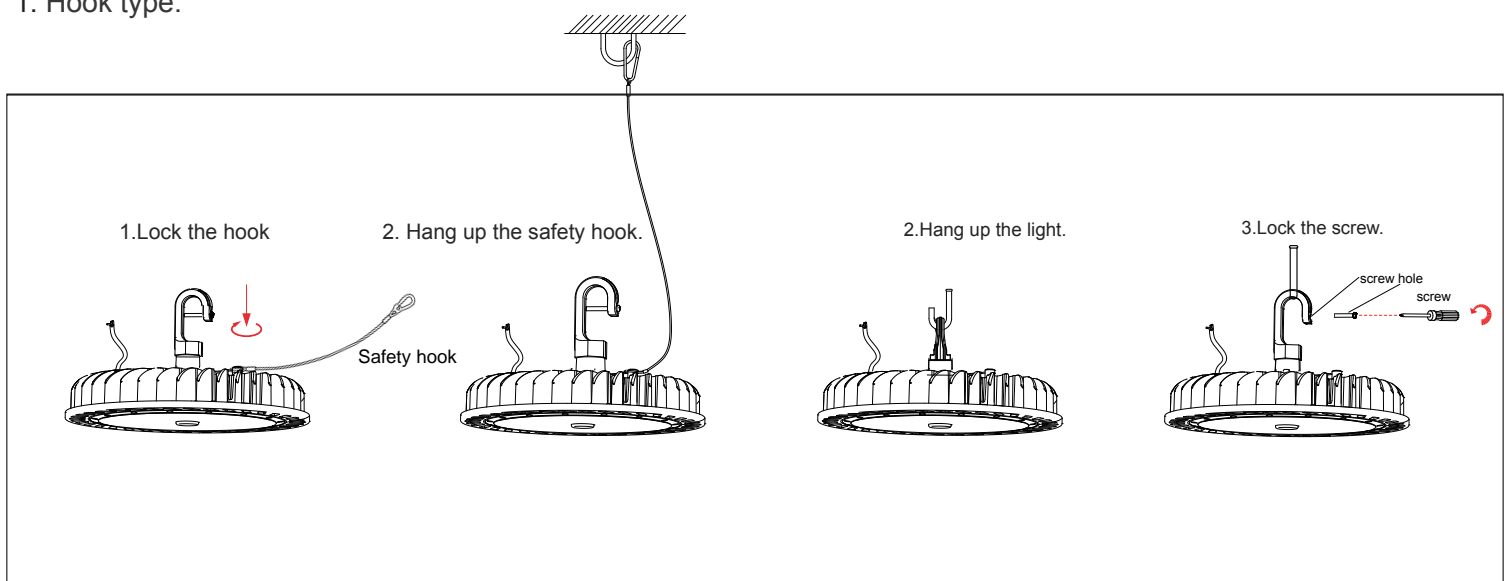

Hykolity LED UFO High Bay Light

INSTALLATION INSTRUCTIONS

Product Dimension

1.Hook type:

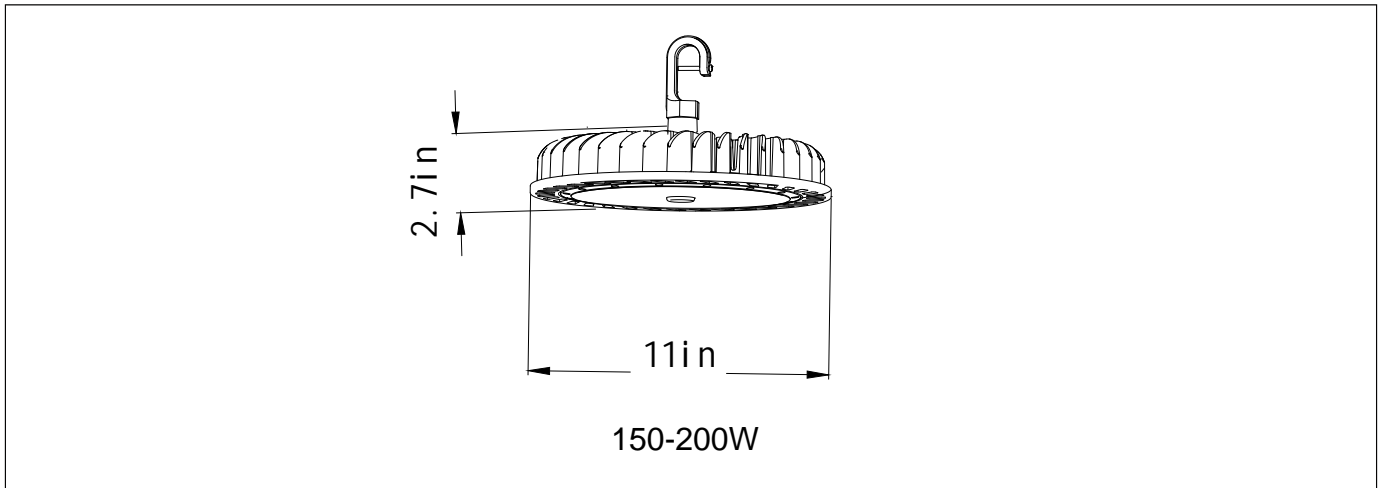

Wiring Diagram & Instruction:

- 1.The length of the plug wire is 5ft.
- 2.The input voltage is 100V-277V.
- 3.Connect the plug with the socket directly, as shown in Figure A. If you do not need a socket, please use the electrician's wire pliers to cut off the plug, as shown in Figure B. After stripping, connect the wire according to the color of the wire, connect AC wire, black wire to L, white wire to N, and green wire to GND.

