

**Item Number: A04115**

**WARNING** (To reduce the risk of fire, electric shock, or injury to persons):

1. We suggest installation by a **licensed electrician**.
2. Please read the instruction carefully and save it as you may need it at later time.
3. Before you start, **NEVER** attempt any work without shutting off the electricity until the work is done. A). Go to the main fuse, or circuit breaker, box in your home. Place the main power switch in the **"OFF"** position. B). Place the wall switch in the **"OFF"** position.
4. Mounting surface should be clean, dry, flat, strong enough and 1/4" larger than the canopy on all side. Any gaps between the mounting surface and canopy exceeding 3/16" should be corrected as required.
5. Make sure that the ceiling or wall can stand the weight of the lamp before installation.
6. Make sure the voltage you are using is **120V**. The maximum wattage is **40W** per bulb.
7. Keep the lamp away from acidic and alkaline substances in case of damaging the surface of the lamp.
8. When replacing bulb, you should turn off or unplug the lamp and you must wait until it is cool as bulbs get hot quickly.
9. The safety instructions appearing in this manual are not meant to cover all possible conditions that may occur. It must be understood that common sense, caution and care must be used with any electrical products.

**IMAGE FOR FINISHED PRODUCT:**

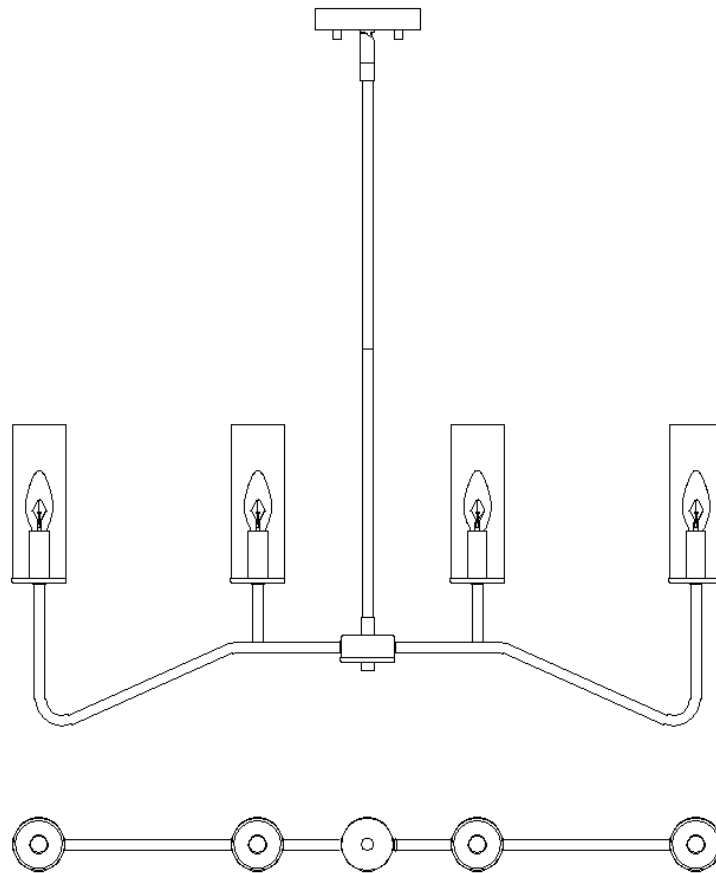

**TOOLS REQUIRED (NOT INCLUDED):**

Before doing assembly and installation please prepare the needed tools as below picture

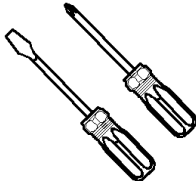
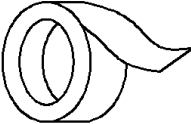
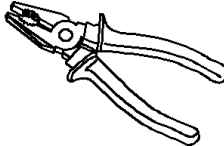
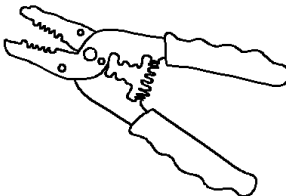
				
Ladder	Phillips head.flat blade screwdriver	Electrical tape	Pliers	Wire cutter/Stripper

**PARTS TYPE & QTY INCLUDING:**

- (C) Mounting plate (1)
- (D) Green ground screw (1)
- (E) Canopy (1)
- (F) Swivel joint (1)
- (G) Knob ball (2)
- (H) Tube
- (I) Glass shade (1)
- (J) Socket (4)
- (K) Arm (2)
- (L) Fixture loop assembly (1)

**ACCESSORIES & QTY ENCLOSED:**

- (A) Plastic wire connector (3)
- (B) Mounting screw (2)

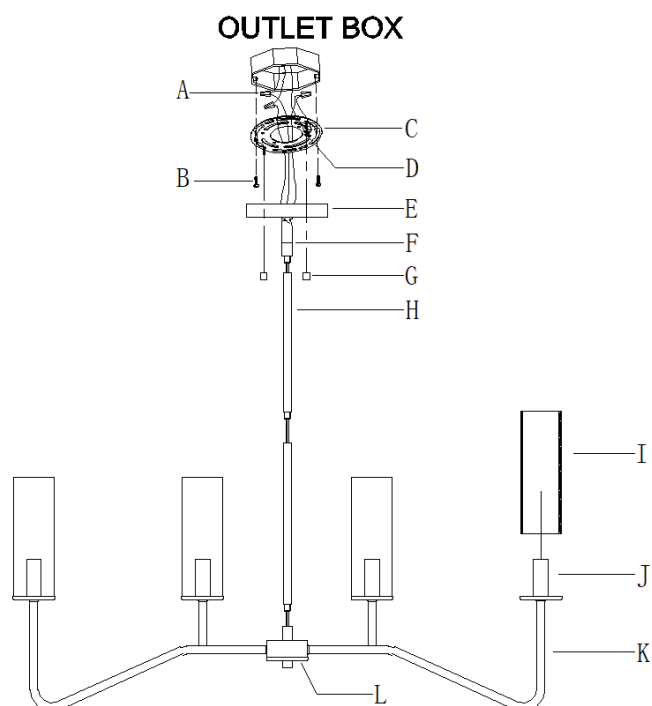

**ASSEMBLY & INSTALLATION INSTRUCTIONS:**

1. Carefully remove the fixture from the carton and check that all parts and accessories are included as shown in the above illustration.
2. **Turn off power**  
**Before you start the installation, NEVER attempt any work without shutting off the electricity until the work is done.**  
**A) Go to the main fuse, or circuit breaker, box in your home. Place the main power switch in the "OFF" position.**  
**B) Place the wall switch in the "OFF" position.**
3. Unscrew the knob ball (G) from canopy (E) then remove the mounting plate (C).

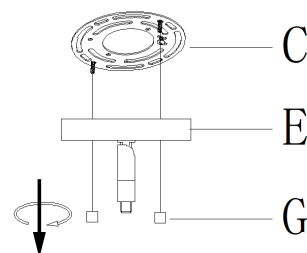

4. 1) According to your desired hanging height to choose and use the tubes (H).

Pass the fixture wires through the tubes (H) the swivel joint (F) and the canopy (E).

2) Thread the chosen tubes (H), the canopy (E) and swivel joint (F) together till snug.

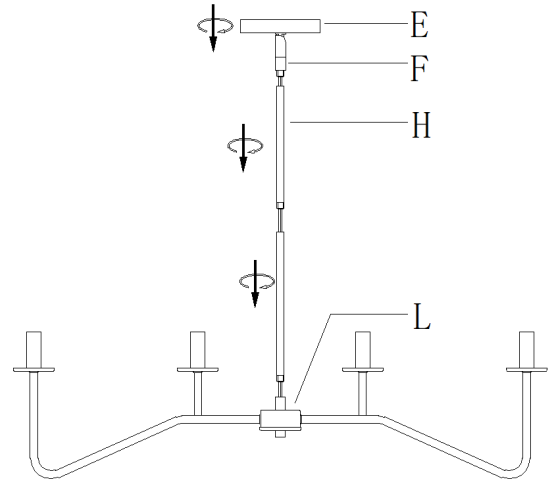

5. Attach the mounting plate (C) to the outlet box with the mounting screws (B).

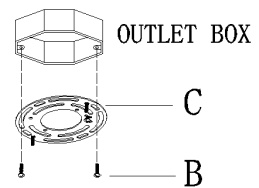

6. Make wire connections

Connect wires as below wires connecting shown. **PLEASE NOTE THAT GROUND WIRE IS BARE COPPER WIRES, NEVER CONNECT OHTER WIRES TO GROUND WIRES.**

**Connect ground wire according to below chart**

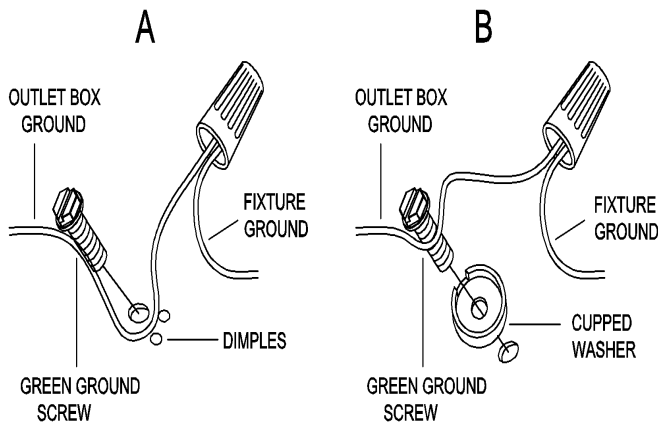

**Connect wires according to below chart**

Connect Black or Red Supply Wire to:	Connect White Supply Wire to:
Black	White
*Parallel cord ( round & smooth )	*Parallel cord ( square & ridged )
Clear, Brown, Gold or Black without tracer	Clear, Brown, Gold or Black with tracer
Insulated wire ( other than green ) with copper conductor	Insulated wire ( other than green ) with silver conductor

\*Note: When parallel wires ( SPT I & SPT II ) are used. The neutral wire is square shaped or ridged and the other wire will be round in shape or smooth ( see illus. )

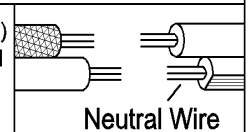

Twist wires together with plastic wire connector (A) until tightly joined, and be sure that no wire strands are exposed then carefully tuck all wires into the outlet box.

7. Raise canopy (E) to ceiling and secure canopy (E) in place by tightening knob balls (G) onto the pre-assembled mounting screws on the mounting plate (C).

**Note: The canopy (E) should be snug against the ceiling and the knob balls (G). If not, adjust the length of the nipples on the mounting plate assembly (C) by unscrewing the pre-assembled hex nuts and then screwing the pre-assembled mounting screws in or out of the mounting plate until the secure length is achieved. Tighten the pre-assembled hex nuts and back to step 7.**

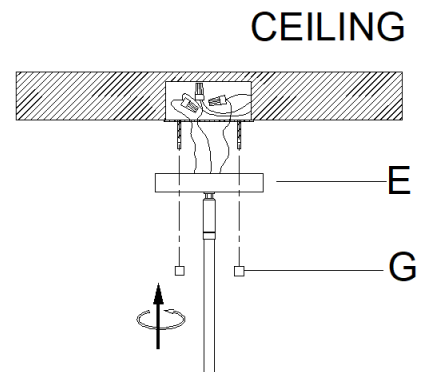

8. 1) Install bulb (Not included) (Please do not exceed the maximum wattage recommended on the socket.)  
2) Carefully place the glass shade (I) on the socket (J).

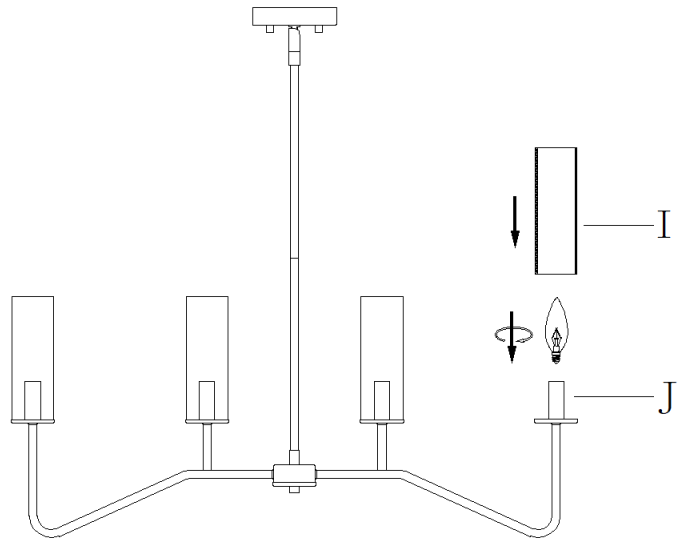

9. Check everything is already installed properly, then you could turn on the light. Enjoy!

**CLEANING.**

To clean, wipe the fixture with a soft cloth. Do not use abrasive materials such as scouring pads or powders, steel wool or abrasive paper.

**ORDERING PARTS.**

Keep this sheet for future reference in case you need to order replacement parts. All parts for this fixture can be ordered from the place of purchase. Be sure to use exact wording from illustration when ordering parts.