

Item Number: A03407

WARNING (To reduce the risk of fire, electric shock, or injury to persons):

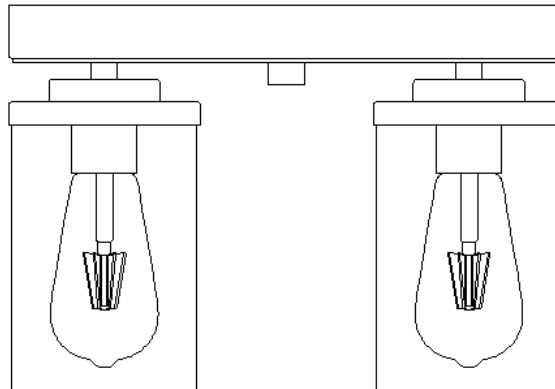



1. We suggest installation by a **licensed electrician**.
2. Please read the instruction carefully and save it as you may need it at later time.
3. Before you start, **NEVER** attempt any work without shutting off the electricity until the work is done. A). Go to the main fuse, or circuit breaker, box in your home. Place the main power switch in the **"OFF"** position. B). Place the wall switch in the **"OFF"** position.
4. Mounting surface should be clean, dry, flat, strong enough and 1/4" larger than the canopy on all side. Any gaps between the mounting surface and canopy exceeding 3/16" should be corrected as required.
5. Make sure that the ceiling or wall can stand the weight of the lamp before fixture.
6. Make sure the voltage you are using is **120V**. The maximum wattage is **60W** per bulb.
7. Keep the lamp away from acidic and basic objects in case of damaging the surface of the lamp.
8. When replacing bulb, you should turn off or unplug the lamp and you must wait until it is cool as bulbs get hot quickly.
9. The safety instructions appearing in this manual are not meant to cover all possible conditions that may occur. It must be understood that common sense, caution and care must be used with any electrical products.

IMAGE FOR FINISHED PRODUCT:

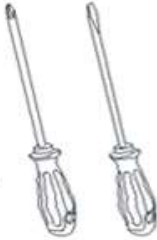

TOOLS REQUIRED (NOT INCLUDED):

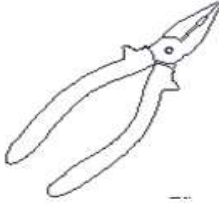
Before doing assembly and installation please prepare the needed tools as below picture

| | | | | |
|---|---|---|--|---|
|  |  |  |  |  |
| Ladder | Phillips head, flat blade screwdriver | Electrical tape | Pliers | Wire cutter/Stripper |

PARTS TYPE & QTY INCLUDING:

- (B) Single bar (1)
- (C) Green ground screw (1)
- (D) Hex nut (2)
- (F) Nipple (1)
- (G) Canopy (1)
- (H) Socket (3)
- (I) Cylinder nut (1)
- (J) Glass (3)
- (K) Socket ring (3)

ACCESSORIES & QTY ENCLOSED:

- (A) Plastic wire connector (3)
- (E) Mounting screw (2)

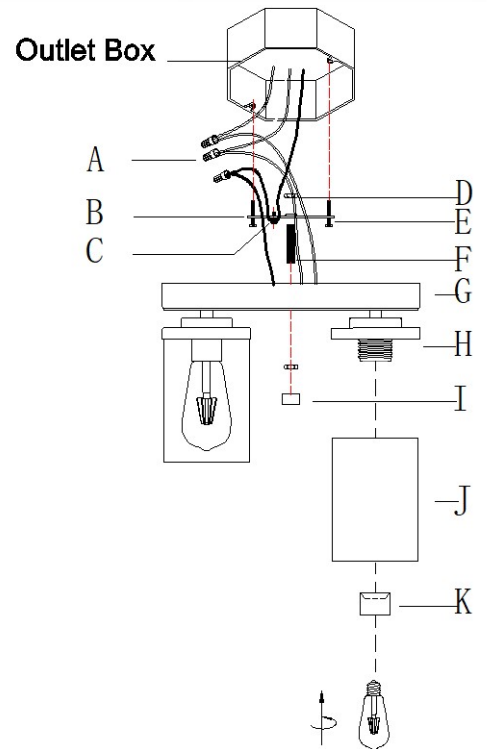

ASSEMBLY & INSTALLATION INSTRUCTIONS:

1. Carefully remove the fixture from the carton and check that all parts and accessories are included as shown in the above illustration

2. Turn off power

Before you start to make installation, NEVER attempt any work without shutting off the electricity until the work is done.

A). Go to the main fuse, or circuit breaker, box in your home. Place the main power switch in the "OFF" position. B). Place the wall switch in the "OFF" position.

3. Attach the single bar (B) to outlet box with mounting screws (E).
The side of single bar marked "GND" must face out

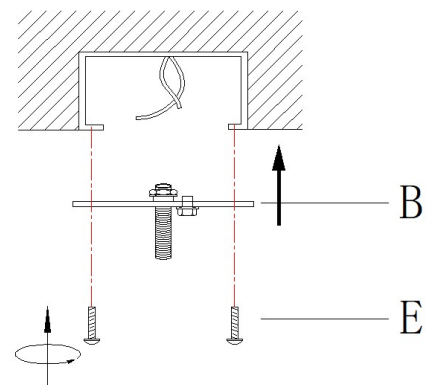

4. Make wire connections

Connect wires as below wires connecting shown. **TAKE NOTE OF THE PROARITY OF THE WIRES ON OUTLET BOX , NEVER CONNECT SUPPLY WIRES TO GROUND WIRES**

Connect ground wire according to below chart

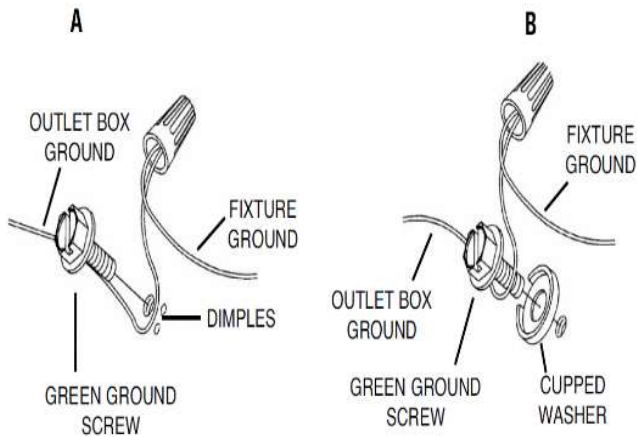

Connect wires according to below chart

| Connect Black or Red Supply Wire to: | Connect White Supply Wire to: |
|---|---|
| Black | White |
| *Parallel cord (round & smooth) | *Parallel cord (square & ridged) |
| Clear, Brown, Gold or Black without tracer | Clear, Brown, Gold or Black with tracer |
| Insulated wire (other than green) with copper conductor | Insulated wire (other than green) with silver conductor |

*Note: When parallel wires (SPT I & SPT II) are used, The neutral wire is square shaped or ridged and the other wire will be round in shape or smooth (see illus.)

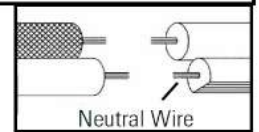

Twist plastic wire connector until wires are tightly joined together,wrap each connector with approved electrical tape.Be sure that no wire strands are exposed and then carefully tuck all wires into the outlet box .

5. Remove the cylinder nut (I) from the single bar assembly .

Fit the canopy(G) to the single bar assembly and secure with the hex nut(D) and cylinder nut(I)

Note: The canopy should be snug against the ceiling and the cylinder nut(I). If not, adjust the length of the nipple(F) on the single bar assembly by unscrewing the preassembled hex nut and then screwing the threaded nipple (F)in or out of the single bar until the length is achieved. Tighten the hex nut and proceed to step 5

CEILING

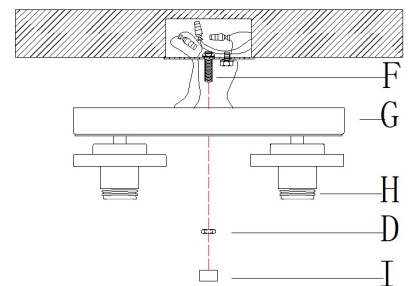

6. Remove the socket rings(K)from the sockets,place the glasses over the sockets(H),secure with socket rings(K)

Install bulb (not included) (Please do not exceed the maximum capacity recommended on the socket.)

CEILING

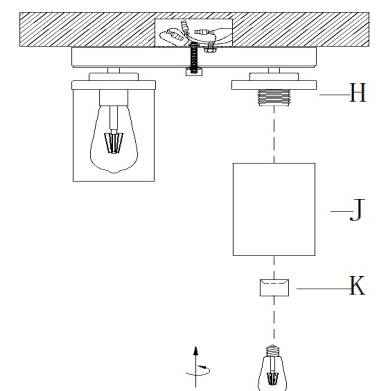

7. Check everything is already installed properly, then you could turn on the light. Enjoy!

CLEANING

To clean, wipe fixture with a soft cloth. Clean glass with a mild soap. Do not use abrasive materials such as scouring pads or powders, steel wool or abrasive paper.

ORDERING PARTS

Keep this sheet for future reference, and in case you need to order replacement parts. All parts for this fixture can be ordered from place of purchase. Be sure to use exact wording from illustration when ordering parts.