

# S1 Ultra User Manual

Please read this manual before operating your device and keep it for future reference.



Distractions can lead to accidents and the risk of injury or death. Always keep your eyes on the road, and keep aware of your surroundings.

**See it, Believe it**

**MIOFIVE**

# Table of Contents

## **Unboxing and Installation-----01**

What's in the box

Product Diagram

Miofive SD Cards

Installation

## **Miofive Dash Cam App-----15**

Miofive Dash Cam App Download

Systems Supported

Using Your Miofive App

## **Operation and Settings-----18**

AI Algorithm

LED Indicator Information

Control Menu

Features

Accessories - Hardwire Kit

## **Updates and Maintenance-----24**

Firmware/App Update

Troubleshooting

## **Specifications and Compliance-----30**

Specifications

Precautions

Product Compliance Information

FCC Statement

Regulatory Certification

## **Support and Community-----34**

Customer Service

Community Promotion Program



## What's in the box

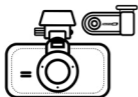

S1 Ultra Dash Cam x 1



Rear Cam Cable x 1



64G MicroSD Card x 1



Car Charger x 1

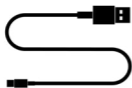

Data Cable x 1



Charging Cable x 1

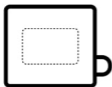

Static Sticker x 4



3M Adhesive x 2



Crowbar x 1



User Manual x 1

## Product Diagram

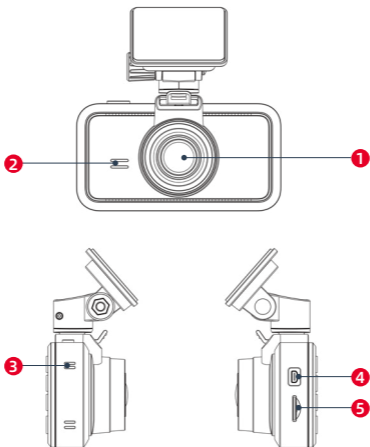

- ① Camera Lens
- ② Speaker
- ③ Vents
- ④ Mini-USB Connector
- ⑤ Memory Card Slot

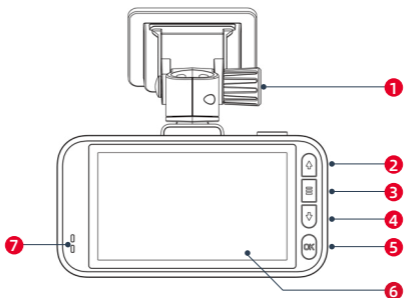

- 1** Adjustment Bolt
- 2** Album/Previous Button
- 3** Setting/Back Button
- 4** Emergency Video/Next Button
- 5** OK (Confirm) Button
- 6** Screen
- 7** Status Indicator LED

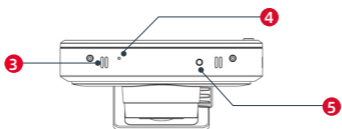
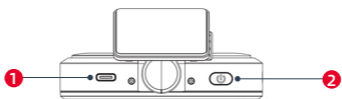

- 1 Power Port
- 2 Power Button
- 3 Vents
- 4 Microphone
- 5 Reset

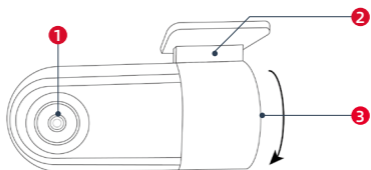

- ① Rear Camera Lens
- ② Brackets (Rotatable support)
- ③ Power Port

# MIOFIVE





## Miofive MicroSD Card

You must insert a memory card (not supplied) before you can start recording. The dash cam supports the **Class 10 memory cards with 64GB - 512 GB capacity**. You should use separate MicroSD cards for recording and regular data storage.

Regularly format your memory card to ensure optimal performance.  
Always backup your data first!

### Note

MIOFIVE

Miofive S1 Ultra Dash Cam is High Bit-Rate 4K Video recording device, which requires High Speed Rating SPECIFIC MicroSD Cards.

Miofive does not guarantee compatibility with memory cards from all manufacturers. We recommend using our Miofive branded SD cards, available on **Miofive.com** and **Amazon**.

Our SD cards are optimized for perfect compatibility with our S1 Ultra dash cam and come with an **18-month Hassle-Free Warranty** for ensured quality.

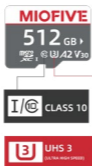

RECOMMENDED MEMORY CARD	
Type >	
UHS >	
Class >	
Max >	512GB

Absolutely do NOT buy Sandisk Cards. Do NOT Purchase it from third party seller on eBay or any online place. Otherwise, they may be fake cards and will NOT work.

### Inserting / Removing the MicroSD Card

Locate the microSD card slot on your device and insert the memory card until it securely clicks into place.

To remove the microSD card, gently press its edge inward until it clicks and pops out. Then, simply pull it out of the slot.

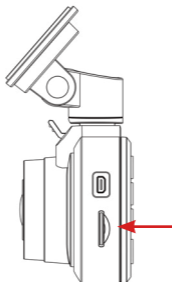
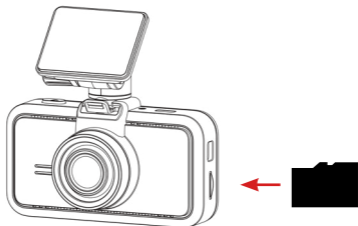

1. Do not insert/remove the microSD card while the camera is turned ON.
2. Before you start recording, please format the microSD card to avoid malfunction caused by files not created by the dash cam.
3. Turn the device off before removing the memory card.

### Formatting the microSD Card

To format the microSD card, navigate to Settings > More settings > Format Memory Card > YES.

Please be aware that formatting the microSD card will erase all existing data. Ensure that you have backed up important files before proceeding with the formatting process.

### CPL Filter

The Miofive Dash Cam CPL (Circular Polarizing Lens) enhances your driving recordings by reducing glare on the windscreen, ensuring clear footage of the road. It protects the front camera lens from fingerprints and scratches, while also improving color and contrast levels.

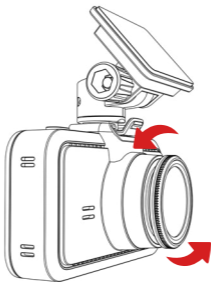

## Installation

### 1. Install the electrostatic sticker

Park your car in a safe area, and turn off the car engine. Take out the electrostatic sticker from the packing box and install it in the recommended area on the windshield, as shown in the figure below. Please clean the windshield and remove the air bubbles between the electrostatic sticker and the windshield during the installation.

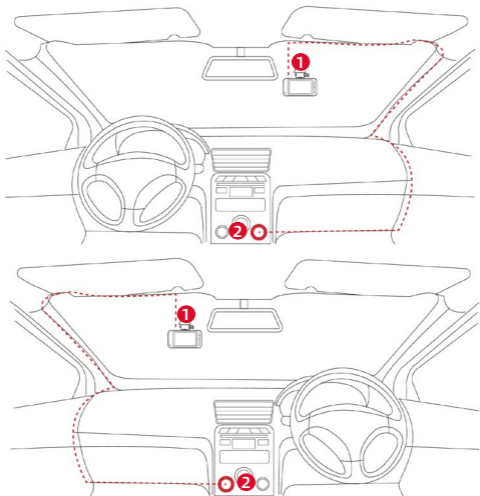

#### Note

MIOFIVE

Please DO NOT attach the dash cam with the sticker to the windshield before the camera calibration to ensure the AI feature works properly.

## 2.Connect the power supply

Connect the USB cable to the USB Type-C port of the ① Dash Cam. Run the cable along the edge of the windshield, tucking it away in the seams (With the Crowbar), and extend it all the way to the USB port of the ② Car Charger. Be sure to keep it away from the airbag area.

Insert the ② Car Charger into your cigarette lighter, and connect the ① Dash Cam to the Car Charger.

### Note

MIOFIVE

Please securely position the car charging cable inside the vehicle. Follow the instructions in the provided diagram to avoid any disruption to the GPS device within the bracket.

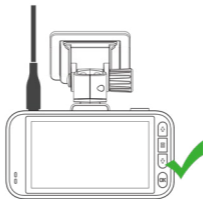
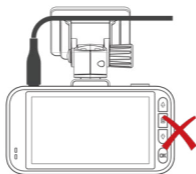

### 3.Camera Calibration

You need to find a good position and angle to install the dash cam. Start the car engine (DO NOT install under driving) to power on and start from pressing the Setting Button in the middle on the right side, find System Settings → AI → Camera Calibration. Align vertical line to the center, horizontal line to the vanishing point of the road in the preview LCD screen as shown below. Make sure the dash cam does not interfere with the driver's view.

#### Note

MIOFIVE

The AI accuracy is dramatically affected by the position of installation. Please install carefully.

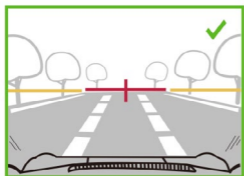

The vanishing point of the road is in the bottom of the image.

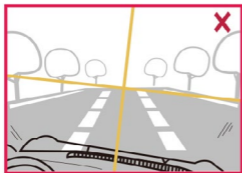

The camera is tilted.



The engine cover occupy too much area in the image.

#### 4. Attach the Dash Cam

Remove the protective sticker on the Dash Cam bracket and attach the Dash Cam to the center of the electrostatic sticker (the sweet spot in step 3), as shown in the figure below. Press the bracket mount by hand to ensure that the heat resistant adhesive is in close contact with the electrostatic sticker. Lock the bracket to the Dash Cam. You will hear a snap when it is in place.

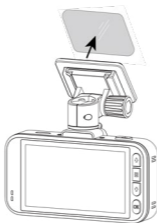

#### 5. Check and adjust the dash cam angle

Ensure your dash cam is installed as the right angle in step 3. You may adjust the camera angle up or down against the preview screen to ensure that the camera is facing correctly.

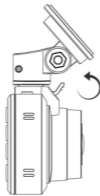

## 6. Mount Attachment

To attach the mount, align the pins on the mount with the holes on the adhesive attachment and slide firmly down until you hear the pieces click into place. To remove the top, do the reverse, and slide it up until you can lift it off the mounting pins.



Scan the QR code below to obtain the operation guide.





## 7. Rear Camera Installation

Select an installation location where the camera can record the complete rear view. Wipe clean the installation surface of the windscreen with a dry cloth. Peel the protection film on the sticky pad and camera lens. Then fix the rear camera on the selected location.

Mount the rear camera as shown below. Use the included rear camera cable to connect the rear camera to the front camera.

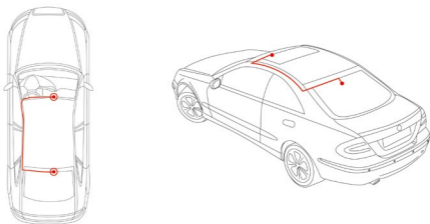

## 8. Hiding the Cable

Make sure the hanging cable does not obstruct your view out of your rear window. Ensure that there are no kinks in the cable as you are stowing it. If necessary, use the crowbar bar supplied with your Dash Cam; this can be used to help pry open the lining of your car (see illustration below).

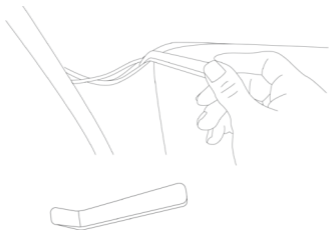

## Miofive Dash Cam App Download

Please scan the QR code below or search [Miofive] in App Store or Google Play to download the App.



### Note

MIOFIVE

In order to connect to Dash Cam Wi-Fi, please list the APP in your trust application list and make sure the Dash Cam Wi-Fi is on.

## Systems Supported:

Android 5.0 and above / iOS 11.0 and above

# MIOFIVE

## Using Your Miofive APP

This section provides guidance on how to connect your smartphone to the dash cam. We recommend registering an account to unlock advanced features.

### Bluetooth Connection:

- 1 Open the app and go to "Devices."



- 2 Choose your device model.
- 3 Press and hold the OK button on the right side of the dash cam for 5 seconds; this will show a QR Code on the screen.
- 4 In the app, click “Start Scanning” to activate scanning mode. Use your phone to scan the QR Code on the dash cam to connect.

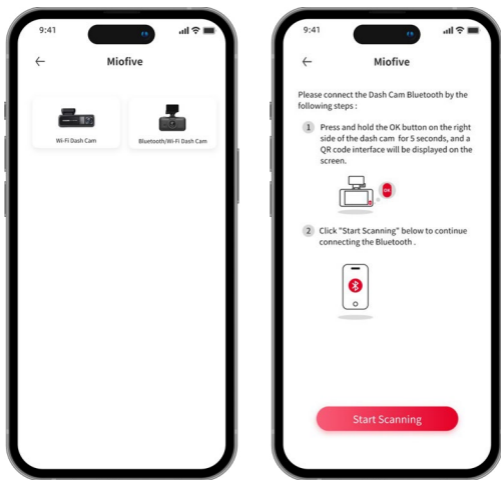

**Note**

If the connection fails, please retry the connection. If issues persist, consider using Wi-Fi for the connection.

### Wi-Fi Connection:

- 1 Check the indicator status on the dash cam, and make sure the power indicator solid on blue.
- 2 Make sure your phone and dash cam are in close range (within 2 meters).
- 3 Go to Phone Wi-Fi Setting and turn Wi-Fi on.
- 4 Choose your Miofive network name (SSID) from the Wi-Fi network list.
- 5 Input the password to connect.(ex. "Miofive\_xxxx" , default password: 1234567890)
- 6 Return to Miofive APP once the connection is complete.

### AI Algorithm

Algorithm	Voice Prompts
Fatigue Driving Alarm	2h: Time to take a break.
	4h: Time to take a break. No drowsy driving.
	6h: Please take a break. Dangerous drowsy driving.
	8h: Danger! Stop driving and take a break.
Harsh Driving Alert	Sudden acceleration, drive safe.
	Sudden braking, drive safe.
	Sudden turn, drive safe.
Stop and Go Reminder	Keep up with the front.

## LED Indicator Information

LED Indicator	Dash Cam Status
Blue LED light solid on	Working, loop recording
Blue LED light blinks	Stop recording, user operating
Blue and red alternating flashes	MicroSD card abnormal
Red LED light solid on	Emergency recording
Red LED light blinks	Firmware updating

## Control Menu

By pressing the button on the right side of the IPS panel, you could enter the control menu.



By pressing this button , the current video clip will be locked and stored in EMER Video.

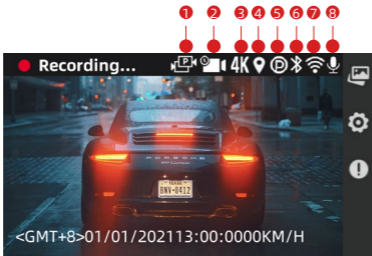

- 1 Rear cam connected
- 2 Time-lapse Recording Setting: Enable
- 3 Front cam recording with 4K resolution
- 4 GPS signal detected
- 5 Parking Monitoring Setting: Enable
- 6 Bluetooth On
- 7 Wi-Fi On
- 8 Microphone On

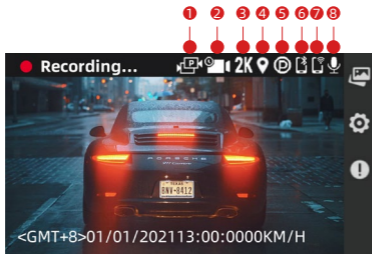

- 1 Rear cam connected
- 2 Time-lapse Recording Setting: Enable
- 3 Front cam recording with 2K resolution
- 4 GPS signal detected
- 5 Parking Monitoring Setting: Enable
- 6 A mobile phone connects to the dashcam via Bluetooth
- 7 A mobile phone connects to the dashcam via Wi-Fi
- 8 Microphone On



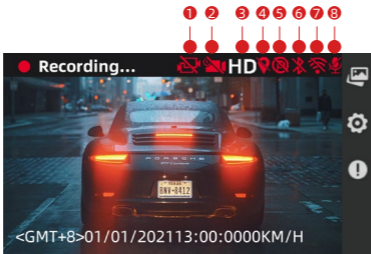

- 1 Rear cam disconnected
- 2 Time-lapse Recording Setting: Disable
- 3 Front cam recording with HD (1080P) resolution
- 4 No GPS signal
- 5 Parking Monitoring Setting: Disable
- 6 Bluetooth Off
- 7 Wi-Fi Off
- 8 Microphone Off

## Features

### Note

MIOFIVE

Not all features are listed in this manual.

### Parking Mode

When your car is not running, i.e. the engine is turned off, the Dash Cam will automatically power off in 10 seconds and enter the Parking Mode. When a shock or crash is detected, the G-Sensor will activate the Dash Cam and start recording a 60-second video. The Dash Cam will then reenter the Parking Mode.

### Time Lapse

Time Lapse recording is a technique whereby the frequency at which file frames are captured (frame rate) is lower than that used when playing back the recording. Time Lapse recording can be considered the opposite of slow motion, as when there recording is played back time appears to be moving faster. This feature operates for up to 24 hours after the ignition is turned off.

### Note

MIOFIVE

Use of this function requires a Miofive USB Type-C hardware kit (NOT included) to provide a constant power supply.

### Emergency Recordings

A 60-second video will be captured when the G-Sensor is activated in case of sharp turns or a sudden stop. When the capacity of these videos reaches 30% of the SD card space, the oldest ones will be overwritten by the new ones.

### Travel Log

Travel Log records the driving path of your journey. Your video and photo will store the GPS information and show the geography in your album. Your journey could be stored in your personal account in the cloud.

No personal data is collected. All GPS log data is stored anonymously in the US Amazon Web Service.

### **Accessories - Hardwire Kit**

Miofive USB Type-C Hardwire Kit is NOT Included in the packaging. Purchase separately.

The Miofive Hardwire Kit supplies power to your car recorder when the engine is switched off by connecting the car recorder cable to the car battery.

## **Firmware/APP Update**

### **APP Update**

Once there is a new App version released, your mobile system and the App will send an update notification. Follow the prompts to update it.

### **Firmware Update**

Firmware update can be achieved through OTA (Over The Air)

Open APP - Connect To Dash Cam - Enter Settings - Firmware Update, then follow the prompt to upgrade.

DO NOT power off the Dash Cam during the update. The Dash Cam will restart automatically after the firmware is successfully updated. Please contact us immediately if the update fails.

## Troubleshooting

Scenario	Malfunction symptom	Root cause/Solution
Installation	Image blur	<ol style="list-style-type: none"><li>1. Make sure the lens protector is removed.</li><li>2. The windshield might reflect, slightly adjust the camera angle to avoid reflection.</li></ol>
	Day and night image quality differs a lot	Normally the window film's transparency rate is between 68%~80%, it will affect the recording results.
	Power disconnect frequently	Due to different car models, please adjust the car charger angle to avoid losing position.
	The rear cam is not working	<ol style="list-style-type: none"><li>1. The rear cable is not properly connected, please check all the cable connections and make them tight.</li><li>2. If there is a fault in the rear cam or cable, please contact us.</li></ol>
Connecting to PC	Cannot find external storage	Please use a USB cable that supports data transmission (The charging cable in the box does NOT support data transmission).

Start up	Unable to start	<ol style="list-style-type: none"> <li>1. Make sure the car charger indicator light is on, if not please reinstall the car charger.</li> <li>2. The built-in battery might be low, please connect the USB cable to a power source.</li> <li>3. Press the power button for 8 secs to shut down. After shut down, press the power button to reboot.</li> </ol>
	Welcome screen stops, screen black out, button does not work	Press the power button for 8 secs to shutting down. After shut down, press the power button to reboot.
Recording	Did not start recording automatically after start up	<ol style="list-style-type: none"> <li>1. Reboot the dash cam.</li> <li>2. Format your SD card from within the Dash Cam setup menu.</li> </ol>
	Stops recording abnormally	Format your SD card from within the Dash Cam setup menu.
	LCD screen black out	If "LCD Auto-Off" is on, the camera will enter power saving mode if no operation been performed for 30 or 60 secs (default). The LCD screen will turn on again after pressing any button.
	Video recorded is blur	<ol style="list-style-type: none"> <li>1. Make sure the lens protector is removed.</li> <li>2. Make sure the windshield or camera lens is clean.</li> </ol>

	No sound is recorded in the video	<ol style="list-style-type: none"> <li>1. Check if the “Microphone” is Off in the Recording settings (The icon on the right upper LCD screen shows mute).</li> <li>2. Turn the “Microphone” On in the “Recording settings” .</li> </ol>
	Video time stamp incorrect	<ol style="list-style-type: none"> <li>1. Use the APP to connect the dash cam, the dash cam will perform auto time calibration once connected to the APP.</li> <li>2. Manually set the “Date and Time” under “System Settings” .</li> </ol>
	Stops recording abnormally	Format your SD card from within the Dash Cam set-up menu.
Connecting to the App	Cannot connect to dash cam via Bluetooth	<ol style="list-style-type: none"> <li>1. Check Bluetooth Range and Enablement: Ensure that your mobile device is within a reasonable range of the dashcam(within 2 meters). Confirm that Bluetooth is turned on in both your mobile device and the dashcam.</li> <li>2. Restart Connection: If the problem persists, attempt to restart the Bluetooth connection. Reset your dashcam by pressing the reset button located on the bottom of the device. Additionally, turn off Bluetooth on your mobile device, then turn it back on, and try reconnecting.</li> </ol>

		<p>3. Verify Bluetooth Device Functionality: Confirm that your mobile device is working properly. Test its connection with other devices to ensure functionality.</p> <p>4. Switch to Wi-Fi Connection: If the Bluetooth connection remains unsuccessful, consider trying to connect via Wi-Fi. Ensure you are in a stable wireless environment, and follow the Wi-Fi connection instructions provided in the user manual.</p>
	<p>Cannot connect to dash cam via Wi-Fi</p>	<p>1. Make sure your phone Wi-Fi is turn on (For iOS users, select Miofive's Wi-Fi SSID under Wi-Fi settings).</p> <p>2. Force close and restart the APP.</p> <p>3. Turn Off the Mobile data. When your smartphone connects to your dashcam, it creates a new Wi-Fi network.</p> <p>In some iOS or Android versions, your camera may stop using that network if it doesn't detect the internet which your dash cam will not provide shutting down data or in some cases, turning on airplane mode and then turning on Wi-Fi will fix the issue of your camera not connecting to your dash cam.</p>

	Cannot playback the recorded video on the mobile phone	Might be related to player or mobile phone's system, please try to playback on your PC.
	Take too long to connect	<p>1. Ensure Bluetooth and Range: Confirm that Bluetooth is enabled within the correct range(within 2 meters). Restart the connection or check the functionality of the Bluetooth device.</p> <p>2. Check for Interference: The connection might fail due to signal interference. Please use the dashcam in an environment with less interference.</p> <p>3. Mobile Device Overload: Your mobile device's system might be overloaded. Close other apps or reboot the mobile device to optimize performance.</p> <p>4. Update Operating System and App: Ensure your mobile device's operating system and the app are up-to-date. Updating the app to the latest version can resolve compatibility issues and improve connection speed.</p>



## Specifications

Image Resolution	Front - 4K UHD (3840x2160) @30fps Rear - 4K UHD (3840x2160) @30fps
CPU	Novatek processor
Camera	Front - FOV 140,F1.8 Rear - FOV 115,F2.0
Screen	3 inches IPS
Wi-Fi	Wi-Fi 2.4 / 5GHz
Bluetooth	4.2
Storage	Up to 512G Class 10, loop recording
GPS	Built-in GPS
G-SENSOR	Built-in 3 Gyro sensor, motion locking, adjustable sensitivity
Power supply	Super capacitor
Power Input	5V / 2.4A
Dimension	Front - 95 x 54 x 48 mm Rear - 63 x 34.5 x 25 mm
Weight	Front - 151g Rear - 36g
Operating Temperature	-10°C~45°C / 14°F~113°F

## Precautions

### Warning

MIOFIVE

Do not expose this product to rain, moisture or water under any circumstances, doing so may result in the risk of electric shock or fire.

## Important Notices

Please read all precautions, cautions and instructions carefully before using this product to ensure proper and safe usage.

### **CAUTION:**

To reduce the risk of electric shock, do not perform any servicing other than that contained in the instruction manual unless you are qualified to do so. Have the unit serviced by a qualified service technician if;

The unit has been exposed to rain or water.

The unit does not seem to operate normally.

The unit exhibits a marked change in performance.

### **Disposal of your Miofive dash cam**

1. All electrical and electronic products should be disposed of separately from the municipal waste stream via designated collection facilities appointed by the government or the local authorities. Contact local authorities to learn about disposal and recycling options available in your area.

2. The correct disposal of your Miofive dash cam will help prevent potential negative consequences for the environment and human health.

3. For more detailed information about disposal of your Miofive dash cam, please contact your city office, waste disposal service or the shop where you purchased the product.

## Product Compliance Information

### **IC**

Hereby, Miofive declares that the radio equipment Miofive Dash Cam is in compliance with Industry Canada licence-exempt RSS standard(s).

- English:

This device complies with Industry Canada licence-exempt RSS standard(s).

Operation is subject to the following two conditions:

1. This device may not cause interference,
2. This device must accept any interference, including interference that may cause undesired operation of the device.

- French:

Le présent appareil est conforme aux CNR d'Industrie Canada applicables aux appareils radio exempts de licence.

L'exploitation est autorisée aux deux conditions suivantes:

1. l'appareil ne doit pas produire de brouillage, et
2. l'utilisateur de l'appareil doit accepter tout brouillage radioélectrique subi, même si le brouillage est susceptible d'en compromettre le fonctionnement.

Cet équipement est conforme aux limites d'exposition aux radiations de la FCC établies pour un environnement non maîtrisé.

Cet équipement doit être installé et utilisé avec une distance minimale de 20 cm entre le radiateur et votre corps.

## **CE**

Hereby, Miofive declares that the radio equipment Miofive Dash Cam is in compliance with Directive 2014/53/EU.

## **RF Exposure Information (MPE)**

This device meets the EU requirements and the International Commission on Non-Ionising Radiation Protection (ICNIRP) on the limitation of exposure of the general public to electromagnetic fields by way of health protection. To comply with the RF exposure requirements, this equipment must be operated in a minimum of 20 cm separation distance to the user.

## **WEEE**

This product must not be disposed of as normal household waste, in accordance with the EU directive for waste electrical and electronic equipment (WEEE - 2012/19/EU). Instead, it should be disposed of by returning it to the point of sale, or to a municipal recycling collection point.

## FCC STATEMENT

This device complies with Part 15 of the FCC Rules. Operation is subject to the following two conditions:

1. This device may not cause harmful interference, and
2. This device must accept any interference received, including interference that may cause undesired operation.

### Warning

MIOFIVE

**Changes or modifications not expressly approved by the party responsible for compliance could void the user's authority to operate the equipment.**

### Note

MIOFIVE

This equipment has been tested and found to comply with the limits for a Class B digital device, pursuant to Part 15 of the FCC Rules. These limits are designed to provide reasonable protection against harmful interference in a residential installation. This equipment generates uses and can radiate radio frequency energy and, if not installed and used in accordance with the instructions, may cause harmful interference to radio communications. However, there is no guarantee that interference will not occur in a particular installation. If this equipment does cause harmful interference to radio or television reception, which can be determined by turning the equipment off and on, the user is encouraged to try to correct the interference by one or more of the following measures:

- Reorient or relocate the receiving antenna.
- Increase the separation between the equipment & receiver.
- Connect the equipment into an outlet on a circuit different from that to which the receiver is connected.
- Consult the dealer or an experienced radio/TV technician for help.



This equipment complies with FCC radiation exposure limits set forth for an uncontrolled environment. This equipment should be installed and operated with minimum distance 20cm between the radiator & your body.

## Regulatory Certification

The Identifier is available as an E-label within your Dash Cam's System Info pages. To view these Information please follow the steps below: Click About > Select Legal & Regulatory > Show Regulatory Certificaton > Browse by Click Next.

## Customer Service

**Lifetime Support**

**18-month Limited Warranty**

**E-mail: [support@miofive.com](mailto:support@miofive.com)**

If you are having difficulties setting it up, please email us at [support@miofive.com](mailto:support@miofive.com).

99% of all setup problems can easily be resolved and should be able to get you up and running in no time.

PLEASE see up to date information by viewing our website. OR you can follow us on Facebook & Twitter. We frequently update many great contents that are very useful to you on it.



## Community Promotion Program

Miofive has a Community Promotion Program to aid you in extending the warranty by 6 months.

Please join Miofive Community ( Scan the QR Code below ) and share videos caught on the Miofive dash cam to extend your warranty period from 18 months to 24 months.



If you have any thoughts on how we can do better, please feel free to share them with us in this group. We always humbly listen and focus on doing our best to provide the best product and service for you.

Let's enjoy your driving adventure together!

# MIOFIVE

[www.miofive.com](http://www.miofive.com)

# MIOFIVE

[www.miofive.com](http://www.miofive.com)



scan to email us