



PACKING MATERIALS & PREP-HPLC COLUMNS



Innovative



Reproducible



Rugged



Welch Materials, Inc.

Web: www.welch-us.com
Email: info@welchmat.com



Welch Materials, Inc.

Headquarters building ●



COMPANY PROFILE

Welch Materials is a multinational company that develops and manufactures laboratory consumables including HPLC column, Solid Phase Extraction (SPE) cartridge, GC column, Prep column, Flash cartridge and packing materials.

Welch Materials (Shanghai), Inc. was established in 2003 at Shanghai, China and Welch Materials (Zhejiang), Inc. was opened in 2011 at Jinhua, Zhejiang, China. We also have set Welch Materials, Inc. at West Haven, CT, USA and Welch Materials India Pvt., Ltd. at Gurgaon, India.

Our initial strength was our extensive experience on particle surface modification science and techniques. We are experts in bonding chemistry and innovative packing materials for chromatography applications. Through the optimal utilization of our resources, we have developed many innovative LC and GC consumable products, in particular, our six series HPLC columns, Ultisil[®], Welchrom[®], Xtimate[®], Topsisil[®], Boltimate[®] and Blossmate[®].



CONTENTS

01

PACKING MATERIALS



Features of Packing Materials **02/04**

Introduction of Packing Materials **05/09**

02

CHROMATOGRAPHY GLASS COLUMN



Features of Product **10/11**

Introduction of Product **12/13**

03

PREP-HPLC COLUMN



Selection Guide of Prep-Column **14/18**

Product Introduction of High Pressure Preparative Column **19/21**

04

FLASH CARTRIDGE



Features of Flash Cartridge **22/26**

Applications of Flash Cartridge **27/33**

05

PURIFICATION SOLUTIONS



34/38

WELCH UNIQUE PATENTED Technology

Using the finest silica and unique patented technology, Welch Materials produces high-quality chromatographic packing materials.

The use of exceptional silica guarantees high mechanical strength for chromatography packing materials.

During the packing and purification process, the packing materials will bear great mechanical pressure, so the mechanical strength requirements of the packing materials used for preparation are usually higher than those used for analysis. The mechanical strength of packing materials is a very important quality index, which affects the lifetime of packing materials. When packing frequently, packing materials should be very stable, or it will cause packing materials broken, which will inevitably lead to column pressure increase, column efficiency decrease and bad column performance. In order to extend the life of the packing materials, high mechanical strength materials and strong bonding technology are required, thereby improving the customer's production efficiency and reducing the customer's cost in purification.

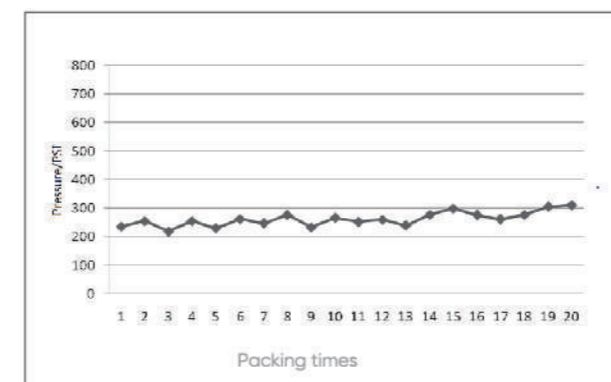

Packing times and pressure

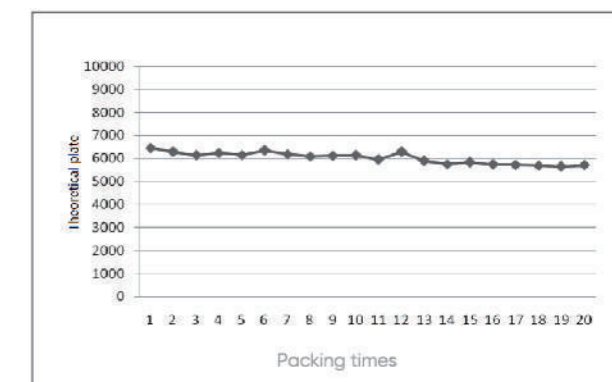

Packing times and column efficiency

Ultra-Pure(purity > 99.999%) spherical and totally porous silica is adopted to ensure high separation column efficiency.

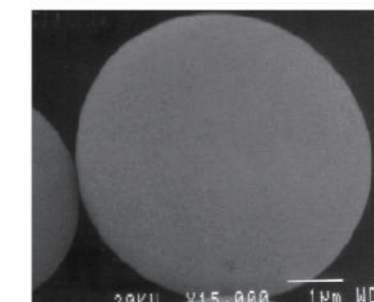
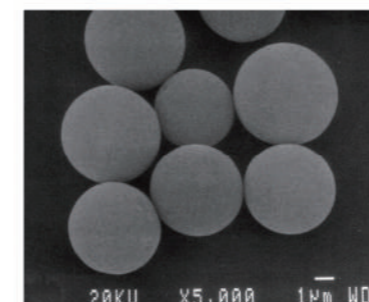

SEM pictures of Ultisil® particles

01 PACKING MATERIALS



Using the finest silica and unique patented technology, Welch Materials produces high-quality chromatographic packing materials.

A uniform distribution of particle and pore sizes leads to efficient separation and allows for a greater sample loading capacity.

Fine particles can increase plate numbers and resolution, but at the same time it will cause difficulties in column packing (it requires higher operating pressure); The packing materials with narrow particle size distribution is easy to be packed evenly, so as to obtain a tighter and more stable column bed, reduce the eddy current diffusion coefficient and improve the column efficiency. Narrow pore size distribution can increase the effective surface area and increase the loading amount. Therefore, the uniform distribution of particle size and pore size is the guarantee of good separation effect and large sample loading.

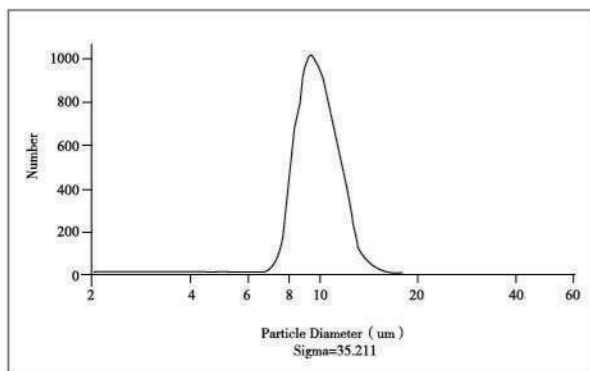

Uniform particle size distribution

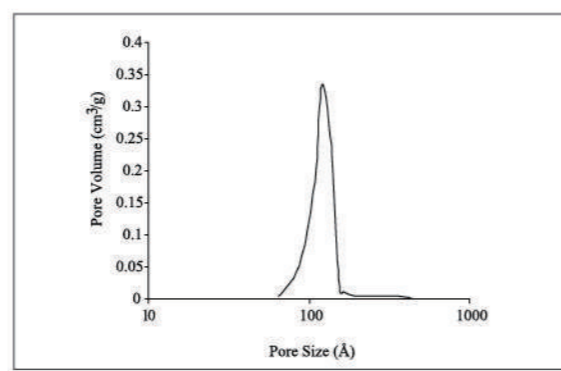

Uniform pore size distribution

Ultra low metal content

Heavy metal content is an important criterion in the evaluation of packing materials. Lower the content of heavy metals, lower the non-specific adsorption of the analyte, and more symmetry the peak shape. Welch selects the extremely low heavy metal content silica gel (content below 1ppm, certified by a third-party testing organization) to guarantee the quality of the packing materials from the raw materials source.

Content of heavy metal

Test method: ICP-MS

Items	Result(mg/kg)	LOD(mg/kg)
Na	Not detected	1.0
Mg	Not detected	1.0
Cd	Not detected	1.0
Cr	Not detected	1.0
Hg	Not detected	1.0
Cu	Not detected	1.0
Fe	Not detected	1.0
CA	Not detected	1.0



Good lot-to-lot reproducibility

The chemical and mechanical stability, pore structure and specific surface area of packing materials are highly reproducible between batches to ensure a long-term, continuous and stable purification production process.

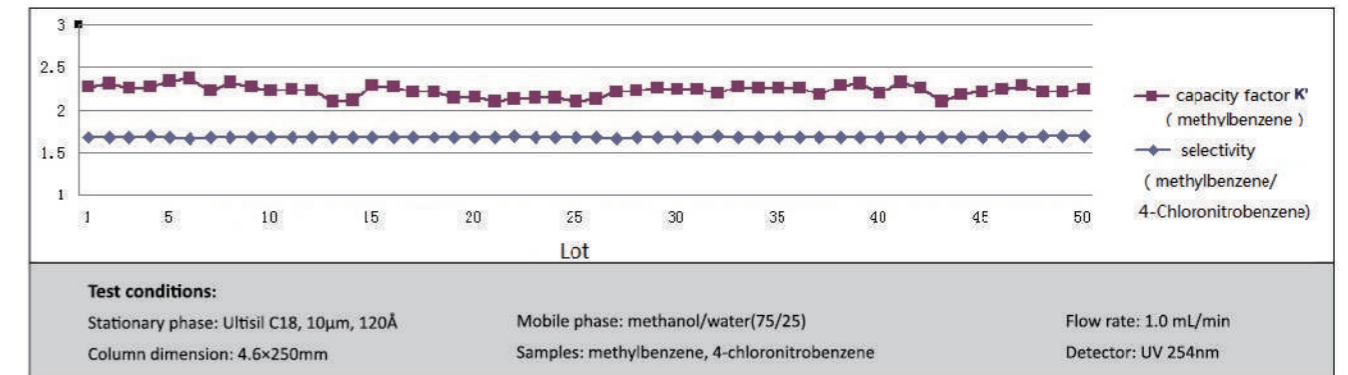

Test conditions:
 Stationary phase: Ultisil C18, 10µm, 120Å
 Mobile phase: methanol/water(75/25)
 Column dimension: 4.6x250mm
 Samples: methylbenzene, 4-chloronitrobenzene
 Flow rate: 1.0 mL/min
 Detector: UV 254nm

Lot-to-Lot Reproducibility between 50 lots of Ultisil® XB-C18 10µm 120Å

pH stability

XB-C18 was tested with different brands of packing materials under extreme conditions of pH 1.3 and 10. The test results are shown in the following figure:

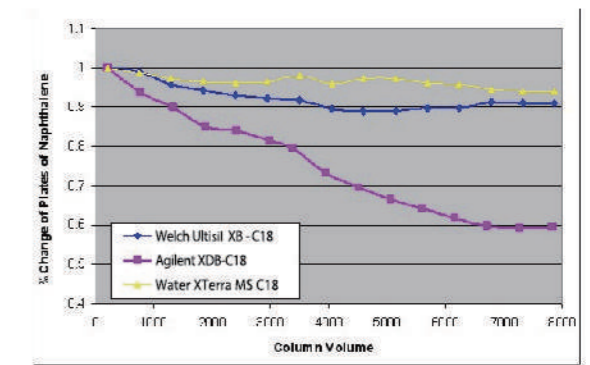
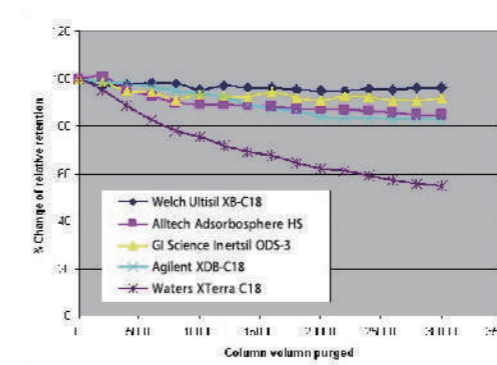

Wide applications of packing materials

Ultisil® XB-C18 packing materials are widely used in the preparation and separation of natural products, chemical raw materials and biologically active substances.

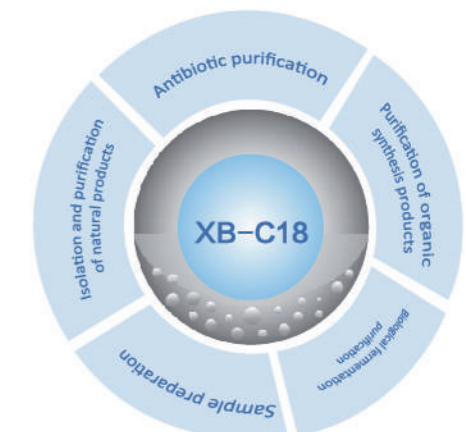

ULTISIL® SERIES

Ultimate Performance Competitive Price

Ultisil® series packing materials is the main packing materials of Welch materials, with particle sizes ranging from 1.8µm to 60µm and dozens of bonded phases to meet the different purification requirements.

Physical parameters:

Bonded phase	XB-C18	XB-C8	LP-C18	AQ-C18	XB-Phenyl	XB-CN	XB-NH ₂	XB-SiO ₂	XB-Diol
Particle size	5µm/10µm	5µm/10µm	5µm/10µm	5µm/10µm	5µm/10µm	5µm/10µm	5µm/10µm	5µm/10µm	5µm/10µm
Pore Size	120Å	120Å	120Å	120Å	120Å	120Å	120Å	120Å	120Å
Surface area	320m ² /g	320m ² /g	320m ² /g	320m ² /g	320m ² /g	320m ² /g	320m ² /g	320m ² /g	320m ² /g
Carbon load	17%	12%	15%	12%	12%	7%	4%	0	2.5%
Endcapped	Yes	Yes	No	Yes	Yes	Yes	No	No	No
pH range	1.5-10.0	1.5-10.0	0.5-8.0	1.5-10.0	1.5-10.0	1.5-9.0	/	/	/

Ultisil® packing materials ordering information:

Bonded phase	5µm	7µm	10µm	15µm	20µm	20-40µm	40-70µm
XB-C18	H02710-02100	H02710-04100	H02710-03100	H02710-05100	H02710-06100	H02710-14600	H02710-11600
AQ-C18	H02712-02100	H02712-04100	H02712-03100	H02712-05100	H02712-06100	H02712-14600	H02712-11600
XB-C30	H02724-02100	H02724-04100	H02724-03100	H02724-05100	H02724-06100	H02724-14600	H02724-11600
XB-C8	H02720-02100	H02720-04100	H02720-03100	H02720-05100	H02720-06100	H02720-14600	H02720-11600
XB-C4	H02760-02100	H02760-04100	H02760-03100	H02760-05100	H02760-06100	H02760-14600	H02760-11600
Polar RP	H02718-02100	H02718-04100	H02718-03100	H02718-05100	H02718-06100	H02718-14600	H02718-11600
XB-Phenyl	H02740-02100	H02740-04100	H02740-03100	H02740-05100	H02740-06100	H02740-14600	H02740-11600
XB-Diol	H02711-02100	H02711-04100	H02711-03100	H02711-05100	H02711-06100	H02711-14600	H02711-11600
XB-CN	H02750-02100	H02750-04100	H02750-03100	H02750-05100	H02750-06100	H02750-14600	H02750-11600
XB-NH ₂	H02730-02100	H02730-04100	H02730-03100	H02730-05100	H02730-06100	H02730-14600	H02730-11600
XB-SiO ₂	H02700-02100	H02700-04100	H02700-03100	H02700-05100	H02700-06100	H02700-14600	H02700-11600
HILIC Amide	H02743-02100	-	H02743-03100	-	-	H02743-14600	H02743-11600
XB-SAX	H02790-02100	H02790-04100	H02790-03100	H02790-05100	H02790-06100	H02790-14600	H02790-11600
XB-SCX	H02714-02100	H02714-04100	H02714-03100	H02714-05100	H02714-06100	H02714-14600	H02714-11600

Other Welch Packing Materials

XB-C30 packing materials

It is a packing material suitable for the separation of structural isomers and retains fat-soluble compounds well.

LP-C18 packing materials

LP-C18 uses special C18 silane as bonding reagent, which makes the bonding degree between the bonding phase and the silica gel much higher than that of the ordinary reversed-phase stationary phase, and it can be protected from hydrolysis under low pH conditions. At the same time, it is not endcapped, which avoids the problem of changing C18 selectivity due to the easy hydrolysis of endcapped reagents under acidic conditions, so that it has better separation performance, stability and longer service life under acidic mobile phase conditions.

XB-Diol packing materials

It is suitable for most normal phase chromatography applications, and can also be used in HILIC mode. Suitable for the separation of peptides, proteins and polar drug molecules, as well as organic acids.

XB-C8 packing materials

C8 is less retentive than C18, so it is recommended for the separation of strongly hydrophobic compounds and LC/MS applications. When separating neutral or other highly retained compounds, XB-C8 can save analytical time.

Special spherical packing materials for low pressure separation and purification

Packing materials based on spherical fully porous silica gel with low metal impurity content and particle size of 20/40µm and 40/70µm are used

AQ-C18 packing materials

It is a 100% water resistant packing material. As a result of moderate surface coverage and complete endcapping make it compatible with the mobile phase with high water content.

XB-Phenyl packing materials

It has excellent separation effect on aromatic compounds, polar compounds and difficult-to-separate drugs.

XB-CN(cyano group) packing materials

It can be applied in both normal phase and reversed phase, with unique selectivity for polar compounds, good peak shape for the separation of strong basic compounds (including ammonium salts), and it is a different option from C18, C8, etc.

Polar-RP packing materials

It is a polar embedded C18 chromatographic packing material, which is not only resistant to 100% water, but also has better retention and selectivity for polar components.

Chiral packing materials

Ultisil® Chiral Amy-D silica is coated with amylose-tris(3,5-dimethylphenylcarbamate), and it is the most commonly used chiral column. It can be applied to the separation of chiral compounds containing aromatic groups, nitro groups, carbonyl groups, amide groups, amino groups, carboxyl groups, cyano groups, hydroxyl groups, sulfonyl groups, etc., as well as the chiral separation of macromolecular compounds with steric hindrance of asymmetric points.

Ultisil Chiral Cellu-D is coated with cellulose-tris(3,5-dimethylphenylcarbamate), which is especially suitable for the separation of beta-blockers and steroids.

XTIMATE® PACKING MATERIALS

Wide pH Range Perfect Peak Shape

Xtimate® series packing materials derives its outstanding performance from a special hybrid particle based technique, which coats a unique 5nm organic/inorganic polymer layer on the silica surface, so that the pH range is extended to 1.0-12.5. Therefore, Xtimate packing materials not only has stable alkali durability, but also has the characteristics of direct amplification of separation, the highest column efficiency and the longest service life.

Physical parameters:

Parameter	C18	C8	Phenyl-Hexyl
Particle size	5µm/10µm	5µm/10µm	5µm/10µm
Pore diameter	120Å	120Å	120Å
Carbon load	14%	10%	12%
pH range	1-12.5	1-12.5	1-12.5

In addition to the above 120Å pore size packing materials, 200Å and 300Å pore size packing materials are also available.

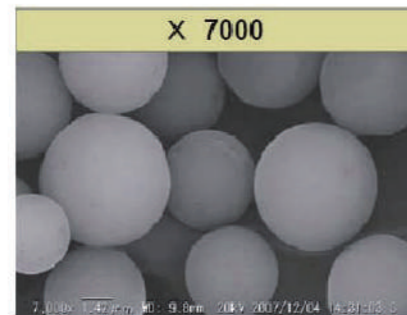
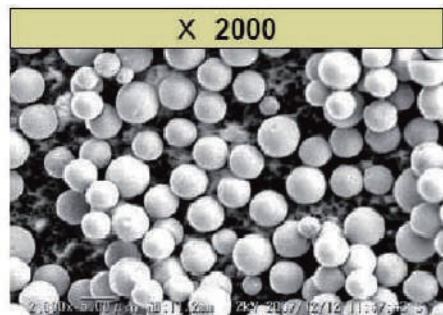

Hybrid particle SME diagram (2000x/7000x)

Hybrid Particles Based Xtimate Technology:

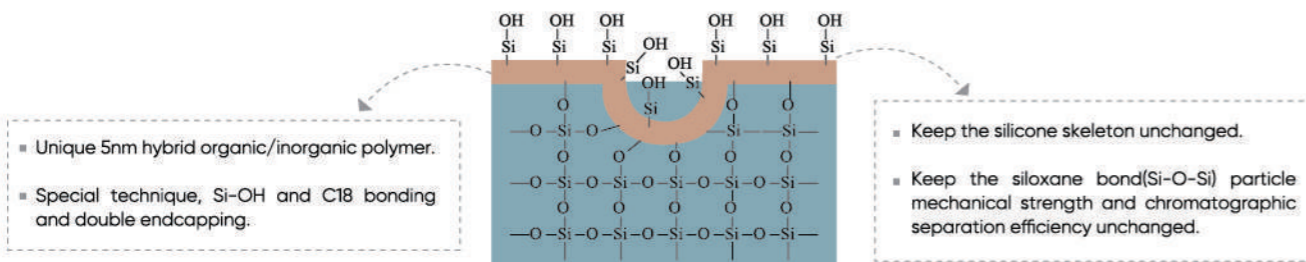

■ Lifetime Test Comparison:
5 Times Longer Than Gemini

■ High pH tolerance
(verified by third-party testing agency)

色谱柱 pH 耐受评价

一、色谱柱信息:
 试剂类型: Xtimate™ C18, 4.6×250mm, 5µm
 序列号: 411401568
 试剂批号: 4101.15
 测试者: 浙江月旭材料科技股份有限公司

二、评价方法:
 流动相: 水/乙腈 = 35/65 (V/V)
 流速: 1mL/min
 柱温: 25°C
 进样量: 20µL
 目标峰: 甲苯
 计算公式: $N = 5.54 \times (t_{R0.95} / W_{0.95})^2$
 其中: N : 理论塔板数
 $t_{R0.95}$: 甲苯保留时间
 $W_{0.95}$: 甲苯峰宽度

三、实验方法:
 每次测定理论塔板数后, 以水(三乙胺调 pH 至 12.0)冲至 100% 有机相(100% 乙腈)流速冲至至基线稳定后, 以低流速冲至 120 倍柱体积, 密封并室温保存, 能 6-7 天测定柱效, 连续测定 36 天。

四、结论:
 评价对象在 pH=12.0 的存放条件下, 在测定时间内柱效未见明显下降, 亦无下降趋势, 体现了在高 pH 存放条件下可保持良好稳定性。

甲苯峰的理论塔板数测定结果

浙江月旭材料科技股份有限公司
测试专用章
2024.5.12

Ordering information for Xtimate® packing materials:

Particle size	C18	C8	SiO ₂	NH ₂	Phenyl-Hexyl	CN	Polar-RP
5µm	01710-02100	01720-02100	01700-02100	01730-02100	01770-02100	01750-02100	01718-02100
10µm	01710-03100	01720-03100	01700-03100	01730-03100	01770-03100	01750-03100	01718-03100

AMORPHOUS SILICA Packing Materials

Different from the above spherical silica-based packing materials, Welch Materials also provide amorphous silica-based packing material.

- The high-purity silica gel with extremely low metal content reduces the interaction between metal ions and samples, ensuring excellent chromatographic performance and avoiding peak tailing caused by high metal content.
- The narrow particle size distribution ensures that more than 90% of the particles are within the specified range, thereby ensuring high column efficiency and stable retention time, while also improving the separation and purification efficiency of the samples.
- The high specific surface area provides high separation performance and can tolerate higher sample loading.
- The 40-63 μ m packing material can be exclusively used for filling Flash cartridges, SPE cartridges, and other similar columns.



Amorphous packing materials order information:

Particle size	C18	C8	SiO ₂
40-63 μ m	00559-11053	00505-11053	00500-11053

02

CHROMATOGRAPHY GLASS COLUMN



Experience the ultimate in pressure resistance and optimal flow with our patented cylindrical design and imported SCHOTT glass firing, our glass columns feature the most rounded inner wall, ensuring optimal separation efficiency.

CHROMATOGRAPHY

Glass Column

Experience the ultimate in pressure resistance and optimal flow with our patented cylindrical design and imported SCHOTT glass firing, our glass columns feature the most rounded inner wall, ensuring optimal separation efficiency.

Features:

- Flared column head: the unique column head design replaces the traditional frit design, the fluid distribution is more uniform, and the column efficiency and separation efficiency are improved.
- Solid sample loading: for special samples, solid sample loading and dry method can be used to effectively prevent the damage to the column bed caused by the high linear velocity of the mobile phase.
- Large sample loading: the pump can be used to extract the sample, which can eliminate the phenomenon that the high-concentration sample blocks the valve interface.
- Wide range of uses: packing a variety of packing materials with different particle sizes, such as silica-based C18, PS/DVB resin, agarose gel, etc.
- Fast speed: 2-10 times shorter than the open glass column purification time, purifying drug impurities or API within one hour.
- Humanization: Simple column design, easy to dismantle and wash, and reduce the cost of separation hardware.
- Visualization: You can intuitively understand the separation status of colored samples such as natural extracts and pigments.



Every organic synthesis laboratory should upgrade low pressure chromatography to medium pressure chromatography!

Advantages of medium pressure glass columns:

1. High column efficiency. The longer the column length, the higher the column efficiency, and high-purity samples can be obtained by using a medium-pressure column. When using a Flash cartridge, to obtain high column efficiency, you need to connect several cartridge tubes in series, but the Luer connector is not pressure-resistant and easily collapses when connected in series. The Welch glass column has three sizes of 310mm, 460mm, and 920mm, which correspond to samples that are easy to purify, moderately difficult to purify, and difficult to purify.

- High Pressure Preparative Chromatography—High Purity Difficult-to-Separate Products.
- Medium pressure preparative chromatography – high purity and easy separation of products.
- Low pressure preparative chromatography—fractionation and large-scale separation and purification.

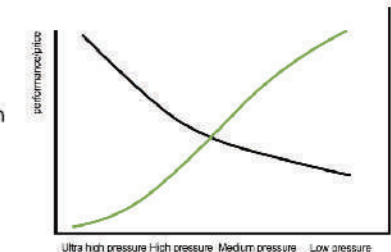

The relationship between pressure and preparation

2. The speed is fast. The higher the flow rate, the faster the purification. The Welch glass column is fired with imported SCHOTT glass. The unique stress relief process makes the pressure resistance of the glass column up to 50bar. With the same sample conditions and column dimensions, higher flow rates can be used for faster purification.

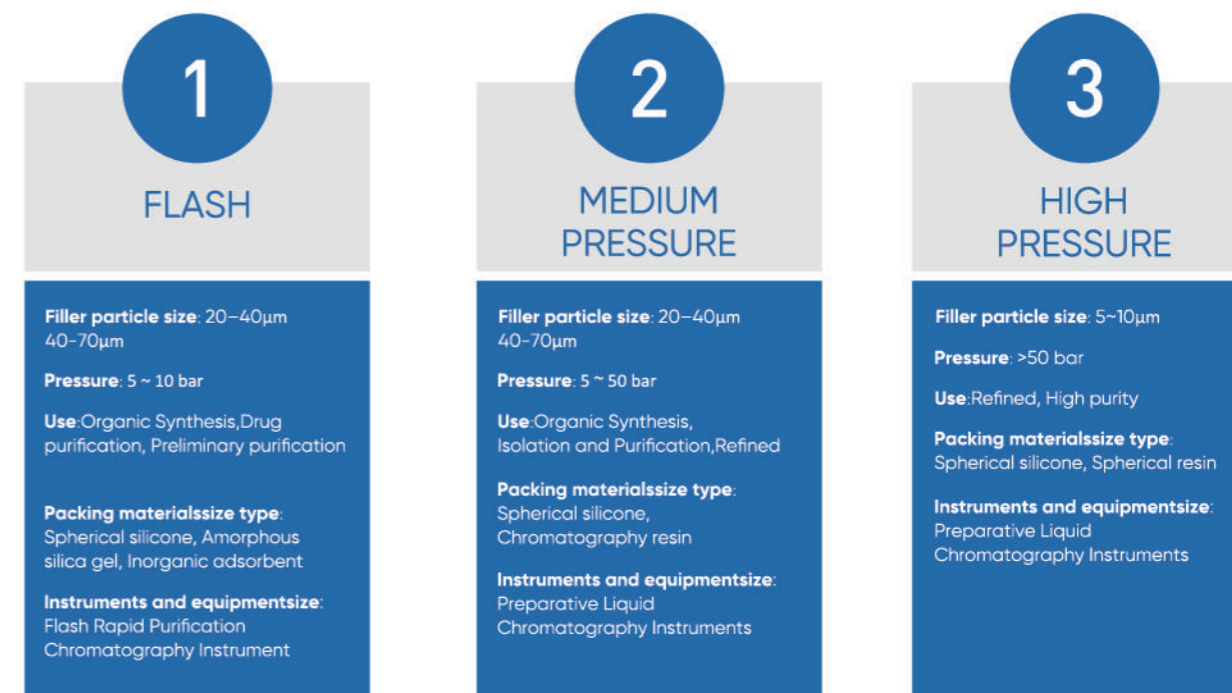

Features of various preparative chromatography systems

3. Low cost. After a few experiments, if a flash cartridge gets dirty, you can only throw away the entire cartridge, which is too wasteful! By using a medium-pressure glass column, if the packing materials gets dirty or the column efficiency deteriorates, you can simply remove the packing materials, replace it with new packing materials, and repack the column. The column can be reused, which reduces costs. Buying one bucket of filler can be used for a year.

4. Easy to use. All medium and low pressure preparation systems can be directly connected to Welch glass chromatography column. The column can be filled with large pore resin for sample enrichment and rough purification, 40-70 μ m C18 for simple sample high purity purification, or 20-40 μ m filler for difficult-to-separate sample high purity purification. One column can have multiple uses, allowing your medium and low pressure preparation system to perform to its fullest potential!

Glass column specifications:

P/N	Name	Specifications (Inner diameter x column length)
00842-02031	Medium pressure glass column	15mm x 310mm
00842-02041	Medium pressure glass column	15mm x 460mm
00842-02051	Medium pressure glass column	15mm x 920mm
00842-03031	Medium pressure glass column	26mm x 310mm
00842-03041	Medium pressure glass column	26mm x 460mm
00842-03051	Medium pressure glass column	26mm x 920mm
00842-04031	Medium pressure glass column	36mm x 310mm
00842-04041	Medium pressure glass column	36mm x 460mm
00842-04051	Medium pressure glass column	36mm x 920mm
00842-05031	Medium pressure glass column	49mm x 310mm
00842-05041	Medium pressure glass column	49mm x 460mm
00842-05051	Medium pressure glass column	49mm x 920mm
00842-06031	Medium pressure glass column	70mm x 310mm
00842-06041	Medium pressure glass column	70mm x 460mm
00842-06051	Medium pressure glass column	70mm x 920mm
00842-07031	Medium pressure glass column	100mm x 310mm
00842-07041	Medium pressure glass column	100mm x 460mm
00842-07051	Medium pressure glass column	100mm x 920mm
00842-08071	Medium pressure glass column	150mm x 300mm
00842-08081	Medium pressure glass column	150mm x 600mm
00842-08091	Medium pressure glass column	150mm x 900mm
00842-09061	Medium pressure glass column	200mm x 500mm
00842-01022	Sample loading column	10mm x 110mm
00842-03012	Sample loading column	26mm x 100mm
00842-05012	Sample loading column	49mm x 100mm
00842-05013	Packing column machine	49mm x 100mm, dry packing

03 PREP-HPLC COLUMN



Experience the highest quality multi-type chromatographic packing materials, paired with a superior column tube design and mature packing technology, our attention to detail ensures exquisite chromatographic separations and the highest level of accuracy in your analyses.

BEST-IN-CLASS QUALITY

Welch Preparative Columns

Experience the highest quality multi-type chromatographic packing materials, paired with a superior column tube design and mature packing technology, our attention to detail ensures exquisite chromatographic separations and the highest level of accuracy in your analyses.

Ultisil® — [One of the best-selling column brands in Welch Materials.]

Bonded phase	USP Classification Number	pH range (Room temperature)	Particle size	Pore size	Specific surface area	Carbon load	Bonded phase	USP Classification Number	pH range (Room temperature)	Particle size	Pore size	Specific surface area	Carbon load
XB-C18 Octadecylsilane bonded silica	L1	1.5-10.0	3µm, 5µm, 10µm	120Å	320/90	17%/8%	XB-C8 Octylsilane bonded silica	L7	1.5-10.0	3µm, 5µm, 10µm	120Å	320/90	12%
	The general-purpose chromatographic column adopts a new type of bonding and double endcapped technology to provide the analyst with a perfect peak shape, and has a very good separation effect on strong basic compounds.							General-purpose column, using a thorough double endcapped bonding process, when separating neutrals or other compounds with strong retention ability, the retention is slightly weaker than that of C18.					
XB-Phenyl Phenylpropylsilane Bonded Silica	L11	1.5-10.0	3µm, 5µm, 10µm	120Å	320/90	12%/6%	AQ-C18 Octadecylsilane bonded silica	L1	1.5-10.0	3µm, 5µm, 10µm	120Å	320	12%
	A general-purpose chromatographic column, an analytical column that is selectively complementary to linear alkanes, and has excellent separation effects on aromatic compounds, polar compounds and difficult-to-separate drugs.							Aqueous column that is resistant to 100% aqueous phase, has better retention of polar compounds than ordinary C18 columns, and has a longer service life in mobile phases with high water content.					
LP-C18 Octadecylsilane bonded silica	L1	0.5-8.0	3µm, 5µm	120Å	320/90	15%/6%	Polar-RP Polar embedded column	L1	1.5-10.0	5µm	120Å	320	18%
	For low pH mobile phases, it has the best stability and longest life.							The polar group is embedded in the alkane chain, which plays a good shielding effect on the free silyl group on the surface of the silica gel. It has a good peak shape when analyzing polar and basic substances, and is suitable for polar and non-polar substances.					
PAH Special column for analysis of polycyclic aromatic hydrocarbons	N/A	1.5-10.0	5µm	120Å	320	22%	AA Special column for amino acid analysis	N/A	1.5-10.0	5µm	120Å	320	17%
C30 Triacetylsilane bonded silica column	L30	1.5-10.0	5µm	120Å	320	17%	Amide Polyacrylamide Bonded Silicone	N/A	1.5-10.0	5µm	120Å	320	N/A
	A column specially designed for the separation of carotenoid isomers.							A hydrophilic column with carbamoyl groups bonded on the surface of silica gel, which has high compatibility with mass spectrometry and is the best choice for separation and analysis of sugars.					
HILIC Amphion	N/A	1.5-10.0	5µm	120Å	320	4%	Chiral Amyd Amylose Coated Silica Chiral Columns	L51	1.5-10.0	5µm	120Å	320	N/A
	The surface of silica gel is bonded with a hydrophilic chromatographic column with zwitterions. The column has high compatibility with mass spectrometry, and can obtain good peak shape for the analysis of neutral, basic and acidic polar compounds.							The surface of silica gel is coated with amylose-tris(3,5-dimethylphenylcarbamate), which can be applied to containing aromatic group, nitro group, carbonyl group, amide group, amino group, carboxyl group, cyano group, hydroxyl group, sulfonyl group. Separation of chiral compounds such as acyl groups, and chiral separation of macromolecular compounds with steric hindrance of asymmetric points.					
Chiral Cellulose-coated silica chiral column	L40	1.5-10.0	5µm	120Å	320	N/A	ChiralImmoAmy Amylose-bonded silica chiral column	N/A	1.5-10.0	5µm	120Å	320	N/A
	Silica-coated cellulose-tris(3,5-dimethylphenylcarbamate), the most versatile chiral column. Especially suitable for the separation of beta-blockers and steroids.							Amylose-tris(3,5-dimethylphenylcarbamate) is bonded to the silica surface. More choices of mobile phase types and more choices of solvents for dissolving samples.					
Chiral ImmoCellulose Bonded Silica Chiral Columns	N/A	1.5-10.0	5µm	120Å	320	N/A	HILIC Silica Hydrophilic Interaction Silica Column	L3	1.5-10.0	5µm	120Å	320	N/A
	Cellulose-tris(3,5-dimethylphenylcarbamate) bonded to the silica surface. Selectivity is enhanced by using solvents such as water as mobile phases that cannot be used with traditional chiral columns.							It is suitable for the separation of compounds that are not retained on reversed-phase chromatographic columns, especially the retention of strong polar basic compounds, and has complementary separation selectivity with reversed-phase chromatographic columns. This column allows the use of highly volatile mobile phases, increasing the sensitivity of LC/MS analysis.					
HILIC NH ₂ Hydrophilic Interaction Amino Column	L8	1.5-10.0	5µm	120Å	320	N/A	Diol Glycol-bonded silica column	L20	1.5-10.0	5µm	120Å	320	2.5%
	Specially treated amino columns for use under reversed-phase conditions for longer life and reproducibility. This column is LC/MS compatible with complementary separation selectivity to reversed-phase columns.							1,2-dihydroxypropyl group is bonded to the surface of silica gel, which is suitable for most normal phase chromatography applications, and can also be used as a stationary phase for HILIC hydrophilic interaction chromatography for the separation of peptides, proteins and polar drug molecules, etc., also suitable for the separation of organic acids and their polymers.					
NH ₂ Aminopropyl bonded silica column	L8	1.5-10.0	5µm	120Å	320	4%	SiO ₂ silica gel column	L3	1.5-10.0	5µm	120Å	320	N/A
	It is suitable for most normal-phase chromatography applications, and can be used in normal-phase separation mode for polar compounds, and is also widely used in reverse-phase separation mode for sugars such as xylose, lactose, and glucose.							The 8-type ultra-high-purity fully porous spherical chromatographic silica has the characteristics of low acidity and low metal content, and is especially suitable for the separation of fat-soluble vitamins.					
CN Cyanobonded Silica Columns	L10	1.5-10.0	5µm	120Å	320	6%	C1 Trimethylsilane bonded silica column	L13	1.5-10.0	5µm	120Å	320	4%
	There are two modes of normal phase and reverse phase. The reversed-phase cyano column has fast elution for hydrophobic molecules, unique selectivity for polar compounds, and good peak shape for the separation of strongly basic compounds. A normal phase cyano column can be used in place of a silica column.							A stationary phase based on ultrapure silica gel and bonded with trimethylsilane. It has the weakest hydrophobicity among all alkyl-bonded phases, and is suitable for the separation of hydrophobic peptide and protein samples in reverse-phase mode, and for the separation of highly polar compounds in normal-phase chromatography.					
C4 Butylsilane bonded silica column	L26	1.5-10.0	5µm	120Å	320/90	8%/3%	UHPLC series column	N/A	1.5-10.0	1.8µm	120Å	300	N/A
	Best for separating mixtures containing components with a wide range of polarities, the butyl-bonded phase gives shorter analysis times and higher resolution.							There are six bonded phases of C18, C8, Phenyl, NH ₂ , SiO ₂ , and LP for customer method development, with pressure resistance up to 1000 bar, with excellent high efficiency and durability, and faster separation while obtaining higher resolution.					

Xtimate® — [The world's leading high-quality liquid chromatography column with ultra-wide pH tolerance range.]

Bonded phase	USP Classification Number	pH range (Room temperature)	Particle size	Pore size	Specific surface area	Carbon load	Bonded phase	USP Classification Number	pH range (Room temperature)	Particle size	Pore size	Specific surface area	Carbon load
C18 Octadecylsilane bonded silica	L1	1.0-12.5	3µm, 5µm, 10µm	120Å	320	14	C8 Octylsilane bonded silica	L7	1.0-12.5	3µm, 5µm, 10µm	120Å	320	10
	The general-purpose chromatographic column adopts a new type of bonding and double endcapped technology to provide the analyst with perfect peak shape, and has a very good separation effect on strong basic compounds.							General-purpose column, using a thorough double endcapped bonding process, when separating neutrals or other compounds with strong retention ability, the retention is slightly weaker than that of C18.					
Phenyl-Hexyl Phenylhexylsilane bonded silica	L11	1.0-12.5	3µm, 5µm, 10µm	120Å	320	12	SEC Silica-based Size Exclusion Columns	N/A	2.0-7.5	5µm, 10µm	120Å, 300Å, 500Å, 1000Å	320	N/A
	A general-purpose chromatographic column, an analytical column that is selectively complementary to linear alkanes, and has excellent separation effects on aromatic compounds, polar compounds and difficult-to-separate drugs.							Aqueous column that is resistant to 100% aqueous phase, has better retention of polar compounds than ordinary C18 columns, and has a longer service life in mobile phases with high water content.					
Ca ²⁺ Calcium-type sulfonated cross-linked styrene-divinylbenzene copolymer	L19	1.0-14.0	5µm, 8µm	N/A	N/A	N/A	H+ Hydrogenated sulfonated cross-linked styrene-divinylbenzene copolymer	L22	1.0-14.0	5µm, 8µm	N/A	N/A	N/A
	Calcium-type strong cation exchange columns based on PS/DVB microspheres with low cross-linking degree and uniform particle size are widely used in sugar analysis.							Hydrogen-type strong cation exchange columns based on PS/DVB microspheres with low cross-linking degree and uniform particle size are widely used in the analysis of organic acids and mixed alcohols.					



How to Choose a Preparative Column?

Judging from the current market demand, the separation and purification of substances such as proteins and peptides is very common, among which the bonded phases of C18, C8, and C4 are mostly used. How to choose the appropriate carbon load and pore size according to the molecular weight of the substance is very important issues.

Choose pore size according to molecular weight:

Molecular Weight	<800	<2000	<10,000	<50,000	<250,000	≥300,000
Pore Size	60 Å	120 Å	200 Å	300Å	1000 Å	≥1000 Å

Choose proper particle size according to stress tolerance:

Pressure	90 bar	40 bar	20 bar	6 bar	4 bar	1 bar
Pore Size	5μm	10μm	15μm	20-40μm	40-70μm	≥200μm

Choose preparative columns based on sample loading and sample property:

Mass Loading	Particle size /μm Diameter/mm	COLUMN EFFICIENCY				
		5 N=90000	10 N=40000	10/20 N=20000	15/30 N=10000	50 N=5000
Test	4.6	▲	▲	▲	▲	▲
10-50mg	10	★	◆	▲	▲	▲
	20	★	★	▲	▲	▲
50-100mg	30	◆	★	◆	▲	▲
0.1-1g	50	▲	★	★	▲	▲
1-10g	100		▲	★	◆	▲
10-100g	150		▲	★	◆	▲
	200				◆	★
≥ 100g	≥ 300				▲	★

★ Most appropriate ◆ Appropriate ▲ According to the purpose

Select particle size, pore size to achieve good recovery according to the sample properties:

Bonding Phase		C18	C8	C4	Molecular Weight
High	120Å	◆	◇	◇	≤ 5000
Plate Number	200Å	◇	◆	◇	5000-20,000
Low	300Å	◇	◇	◆	20,000-100,000

◆ Most appropriate ◇ Appropriate.(The direction of the arrow is to select the test direction)

Determine flow rate, sample loading, start experiment:

- The flow rate of a preparative column is generally proportional to the square of the diameter.
- For example: the flow rate of the 4.6mm analytical column is set to 1mL/min, and the 100mm preparative column can be $1 \times (10/4.6)^2$, which is about 4.7mL/min.
- In order to save the cost of solvent and packing materials, and increase the utilization rate of the column, the sample load is always overloaded. But it is not that the more overload, the better, because the more overload, the lower the number of plates. Under normal circumstances, whether the overload is excessive or not can be based on the reduction of half of the column efficiency. On this basis, overloading will affect the purity of the obtained material, but it will not achieve the purpose.

Preparative column scale-up reference table:

Items	Diameter				
	4.6×250mm	10×250mm	21.2×250mm	30×250mm	50×250mm
Packing Amount(g)	3	13	60	110	350
Scale-up Factor	1	4.73	21.2	42.5	118
Mass Loading(mg)	0.3-30	1.3-130	6-600	11-1100	35-3500
Flow Rate Range(ml/min)	0.5-2	3-9	14-40	28-85	80-250

ULTISIL® SERIES

Preparative Column

Welch Preparative Column uses the same packing materials as does analytical column, to ensure the best reproducibility of analysis and preparative scale. Special packing technique and stainless modular column tube ensure the stability of column bed. The theoretical plate number for 10 μ m column is greater than 35000/m; for 5 μ m column, it is greater than 75000/m, and the peak symmetry is around 0.95~1.20.

Better Column Efficiency and Tailing:

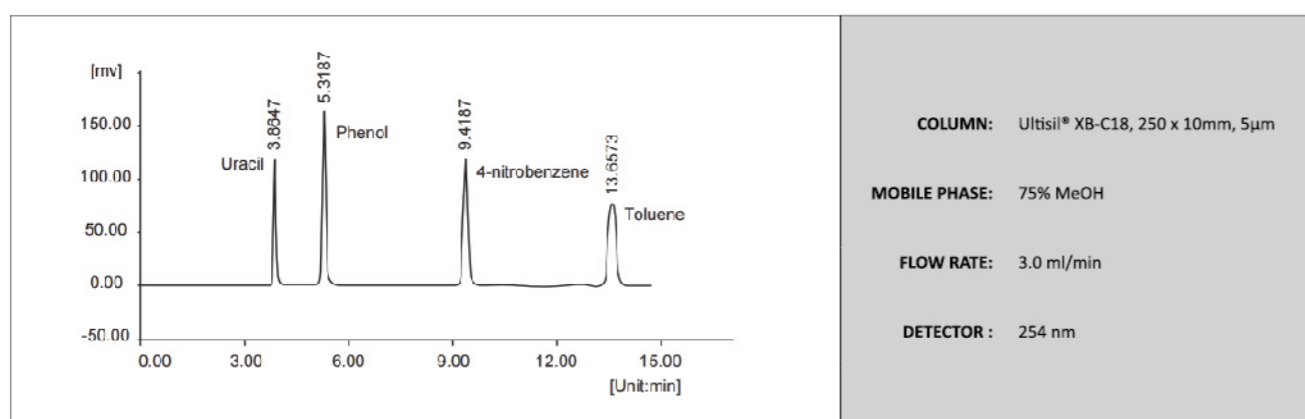

Samples	Retention time (min)	Half Peak Width (min)	Theoretical Plate Number	R	Tailing Factor
Uracil	3.8647	0.0713	16261	0.00	1.18
Phenol	5.3187	0.0933	17990	10.40	1.19
4-nitrobenzene chloride	9.4197	0.1537	20817	19.50	1.11
Methylbenzene	13.6573	0.2210	21157	13.32	1.07

Better Separation Efficiency, Easier for Linear Amplification

Generally, optimization of separation and purification process is done on the analytical column at first. Same packing materials used in analytical and purification process ensures the stability during linear amplification.

Perfect Separation with Different Dimensions:

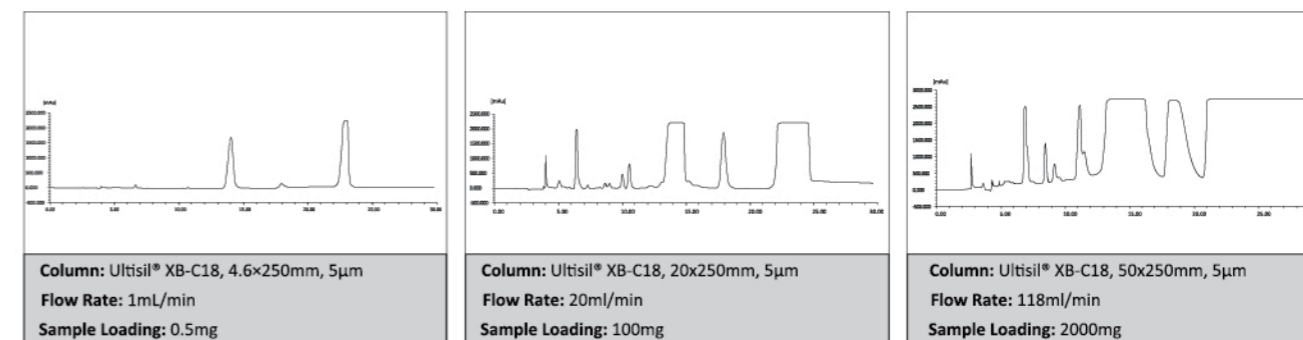

Ultisil® 5 μ m Preparative Column Ordering Information:

Specifications	XB-C18	XB-C8	XB-C30	AQ-C18	XB-Phenyl	Polar RP	LP-C18
10x100mm	H02610-21100	H02620-21100	H02628-21100	H02612-21100	H02640-21100	H02621-21100	H02613-21100
10x150mm	H02610-21101	H02620-21101	H02628-21101	H02612-21101	H02640-21101	H02621-21101	H02613-21101
10x250mm	H02610-21102	H02620-21102	H02628-21102	H02612-21102	H02640-21102	H02621-21102	H02613-21102
21.2x50mm	H02610-21104	H02620-21104	H02628-21104	H02612-21104	H02640-21104	H02621-21104	H02613-21104
21.2x150mm	H02610-21105	H02620-21105	H02628-21105	H02612-21105	H02640-21105	H02621-21105	H02613-21105
21.2x250mm	H02610-21106	H02620-21106	H02628-21106	H02612-21106	H02640-21106	H02621-21106	H02613-21106
30x150mm	H02610-21107	H02620-21107	H02628-21107	H02612-21107	H02640-21107	H02621-21107	H02613-21107
30x250mm	H02610-21108	H02620-21108	H02628-21108	H02612-21108	H02640-21108	H02621-21108	H02613-21108
50x150mm	H02610-21209	H02620-21209	H02628-21209	H02612-21209	H02640-21209	H02621-21209	H02613-21209
50x250mm	H02610-21210	H02620-21210	H02628-21210	H02612-21210	H02640-21210	H02621-21210	H02613-21210

Specifications	SiO ₂	XB-Diol	XB-SAX	XB-SCX	LP-C8	XB-NH ₂	XB-CN
10x100mm	H02600-21100	H02611-21100	H02690-21100	H02614-21100	H02625-21100	H02630-21100	H02650-21101
10x150mm	H02600-21101	H02611-21101	H02690-21101	H02614-21101	H02625-21101	H02630-21101	H02650-21102
10x250mm	H02600-21102	H02611-21102	H02690-21102	H02614-21102	H02625-21102	H02630-21102	H02650-21103
21.2x50mm	H02600-21104	H02611-21104	H02690-21104	H02614-21104	H02625-21104	H02630-21104	H02650-21104
21.2x150mm	H02600-21105	H02611-21105	H02690-21105	H02614-21105	H02625-21105	H02630-21105	H02650-21105
21.2x250mm	H02600-21106	H02611-21106	H02690-21106	H02614-21106	H02625-21106	H02630-21106	H02650-21106
30x150mm	H02600-21107	H02611-21107	H02690-21107	H02614-21107	H02625-21107	H02630-21107	H02650-21107
30x250mm	H02600-21108	H02611-21108	H02690-21108	H02614-21108	H02625-21108	H02630-21108	H02650-21108
50x150mm	H02600-21209	H02611-21209	H02690-21209	H02614-21209	H02625-21209	H02630-21209	H02650-21209
50x250mm	H02600-21210	H02611-21210	H02690-21210	H02614-21210	H02625-21210	H02630-21210	H02650-21210

*Don't find 10 μ m Preparative Columns? Contact Welch or your local distributor for more information.

XTIMATE® SERIES Preparative Column

Xtimate® series Prep columns derives its outstanding performance from a special hybrid particle based technique, which coats a unique 5nm organic/inorganic polymer layer on the silica surface, so that the pH range is extended to 1.0-12.5. Therefore, Xtimate packing materials not only has stable alkali durability, but also has the characteristics of direct amplification of separation, the highest column efficiency and the longest service life.

General characteristics

- High column efficiency, symmetrical peak shape for acids, bases and neutral compounds, good separation effect
- Stable and long service life under wide pH mobile phase conditions
- Can be directly enlarged
- Wide range of bonded phases
- Good mechanical stability and high compressive strength

Xtimate® Series Preparative Columns:

Specifications	Particle size	C18	C8	SiO ₂	NH ₂	Phenyl-Hexyl	CN
10×250mm	5µm	01610-21102	01620-21102	01600-21102	01630-21102	01670-21102	01650-21102
21.2×150mm	5µm	01610-21105	01620-21105	01600-21105	01630-21105	01670-21105	01650-21105
21.2×250mm	5µm	01610-21106	01620-21106	01600-21106	01630-21106	01670-21106	01650-21106
30×150mm	5µm	01610-21107	01620-21107	01600-21107	01630-21107	01670-21107	01650-21107
30×250mm	5µm	01610-21108	01620-21108	01600-21108	01630-21108	01670-21108	01650-21108
50×150mm	5µm	01610-21209	01620-21209	01600-21209	01630-21209	01670-21209	01650-21209
50×250mm	5µm	01610-21210	01620-21210	01600-21210	01630-21210	01670-21210	01650-21210
10×250mm	10µm	01610-31102	01620-31102	01600-31102	01630-31102	01670-31102	01650-31102
21.2×150mm	10µm	01610-31105	01620-31105	01600-31105	01630-31105	01670-31105	01650-31105
21.2×250mm	10µm	01610-31106	01620-31106	01600-31106	01630-31106	01670-31106	01650-31106
30×150mm	10µm	01610-31107	01620-31107	01600-31107	01630-31107	01670-31107	01650-31107
30×250mm	10µm	01610-31108	01620-31108	01600-31108	01630-31108	01670-31108	01650-31108
50×150mm	10µm	01610-31209	01620-31209	01600-31209	01630-31209	01670-31209	01650-31209

04 FLASH CARTRIDGE



Refined bonding processes and precise specifications; Optimal instrument compatibility; Diverse technical applications.

WELFLASH®

Cartridge Introduction

In the process of preparative chromatography separation, fast liquid chromatography columns with high efficiency and stability play an extremely important role in establishing reliable separation and purification technology. A fast column with high separation performance ensures maximum separation of target compounds from impurities.

WelFlash® cartridge is a new generation of flash cartridge produced by Welch Materials through rigorous quality measurement. The narrow size distribution of the packing materials ensures that the column pressure is kept low during use. The shell of the column tube is made of polypropylene material, which also ensures compatibility with various solvents. The product has the advantages of high pressure resistance, good column efficiency and corrosion resistance. The performance parameters of each batch of WelFlash® cartridges are carefully controlled and rigorously tested to ensure a high recovery rate and good reproducibility from batch to batch.

Unique bonding technology

After the optimized silica gel particle size and pore size, Welch's unique bonding technology ensured good reproducibility between packing materials batches

Compatibility

It has good compatibility with most fast liquid chromatography instruments



Multiple Choices

Multiple options: WelFlash® cartridges are available in a wide range of sizes and packing materials

Wide applications

Provide rich technical applications

WelFlash® Packing Materials

The packing materials for WelFlash® cartridges are divided into three types: amorphous silica matrix, spherical silica matrix, and non-silica inorganic adsorbents. Amorphous silica gel packing materials include silica gel and C18, while spherical silica gel has a wide variety of packing materials, including silica gel, C18, phenyl, cyano, amino, ion exchange, Hilic, etc., providing you with a variety of sample selection. Inorganic adsorbents packing materials include acidic, neutral and alkaline alumina packing materials. The fast chromatographic column packing materials consisted of particles ranging from 20 to 75µm, and the particle size distribution was optimized. All WelFlash® cartridge packing materials undergo rigorous quality testing, and parameters such as particle size distribution and pore size are carefully screened to ensure reproducibility from batch to batch.

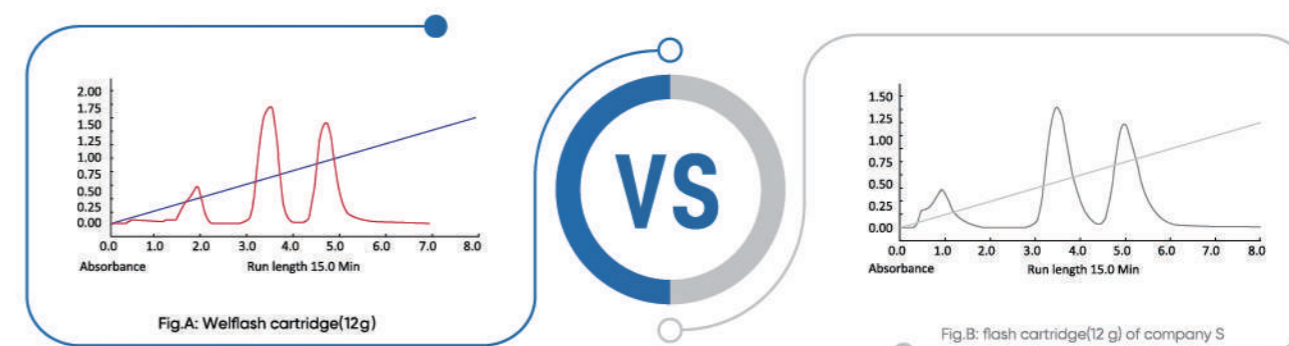

*Excellent Packing Technique

Comparing WelFlash cartridge with S company's flash cartridge at the same chromatographic conditions, one can find that WelFlash achieves baseline separation in shorter time.

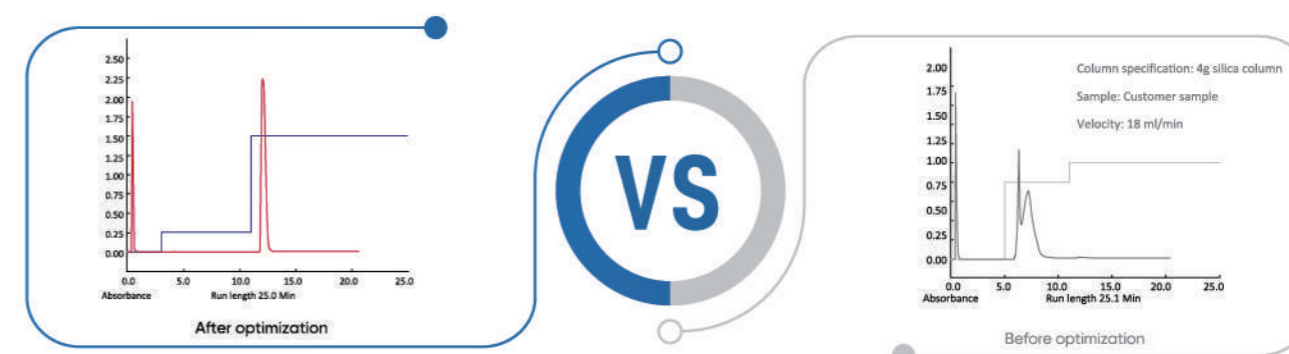

*Optimize Method to Achieve Faster Separation

After method optimization, one can achieve increased adsorption and elution capacity, better peak shape, and smaller half width of main peaks, and therefore save time in sample data collection.



WelFlash® cartridge specifications

The easiest way to shorten separation time is to use short column and high flow rate. But since short column length leads to decreased column efficiency, we recommend column length between 10-75 mm, which is the best proportion after optimization to ensure largest sample loading and best separation efficiency. WelFlash® cartridges are available in the following specifications: 4g, 12g, 25g, 40g, 80g, 120g, 220g, 330g, 800g and 1600g.

WelFlash® cartridge compatibility

- 1) Luer-lok import and Luer export, good compatibility with most systems, such as Isco®, Biotage®, and Armen®
- 2) PP column tube and adapter can tolerate the pressure of regular systems.

Applications—Comparison of Spherical Silica and Amorphous Spherical Silica

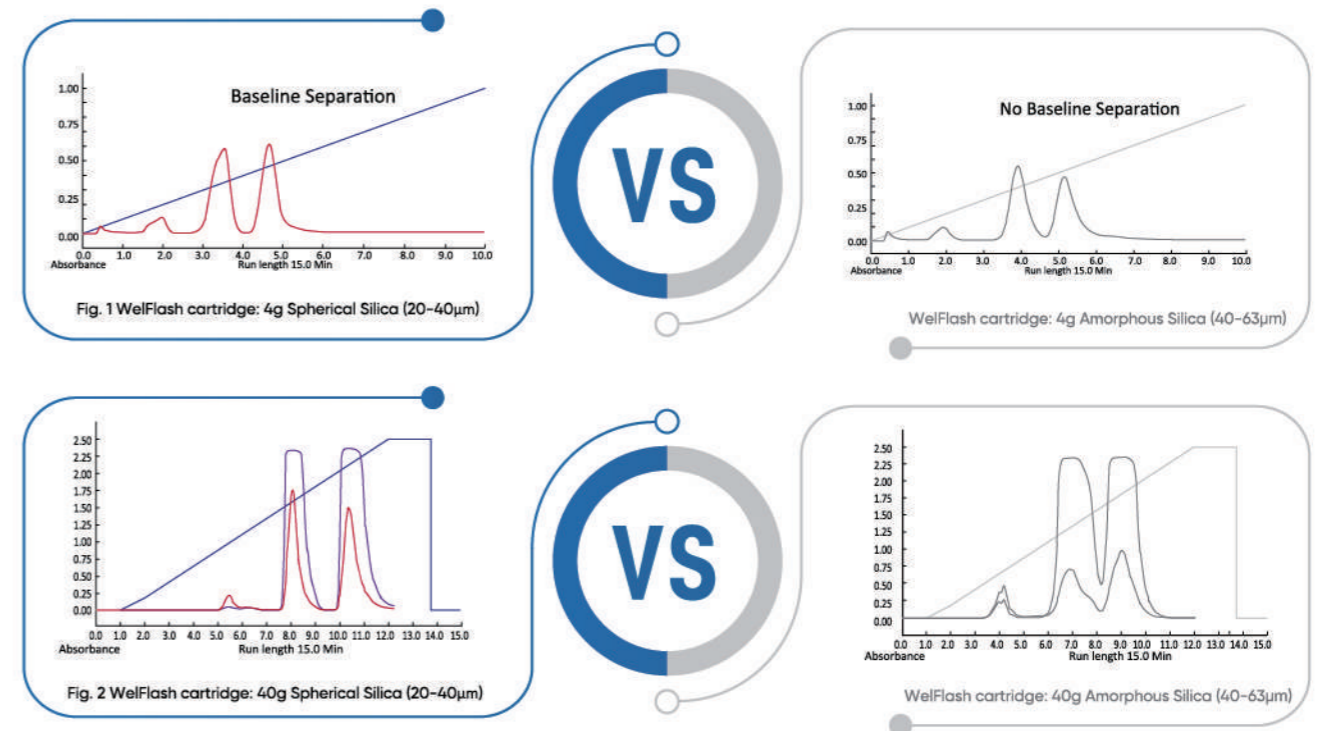

Under same conditions, 4g Spherical WelFlash cartridge can get baseline separation in a short time, but amorphous WelFlash cannot. When compared to 40g amorphous silica column, 40g spherical WelFlash cartridge shows better performance.

Strict Products Quality Testing Process:

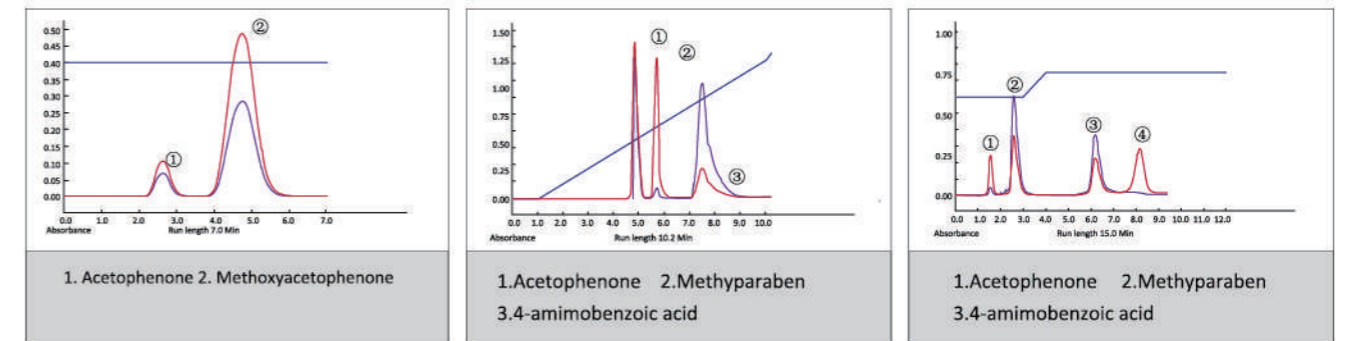
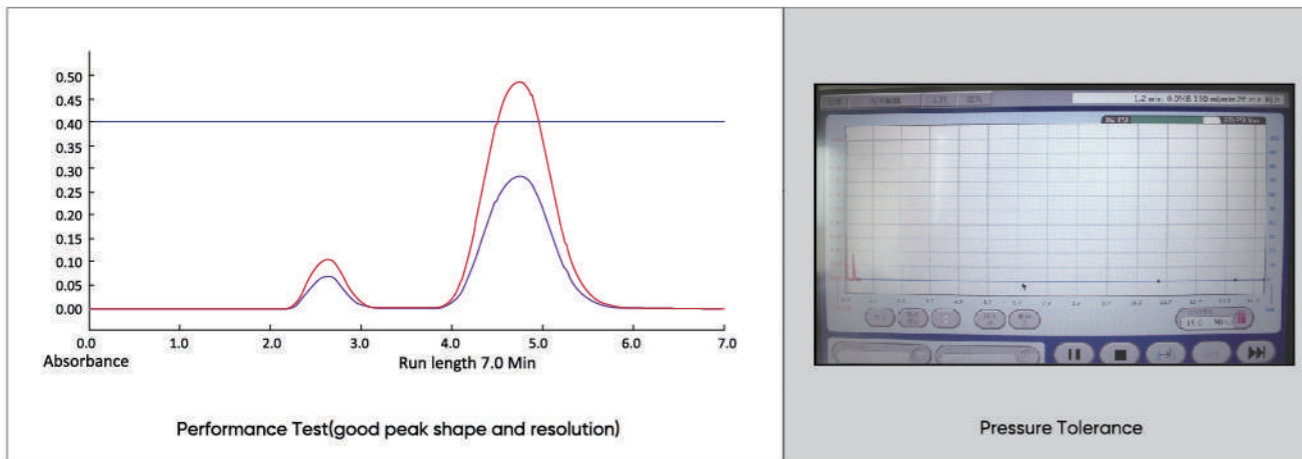

Application of silica Flash cartridge

Application of Silica Flash cartridge

Application of Reversed phase C18 Flash Cartridge

WELFLASH® SiO₂ LS

NEW Flash Cartridge Tube Design

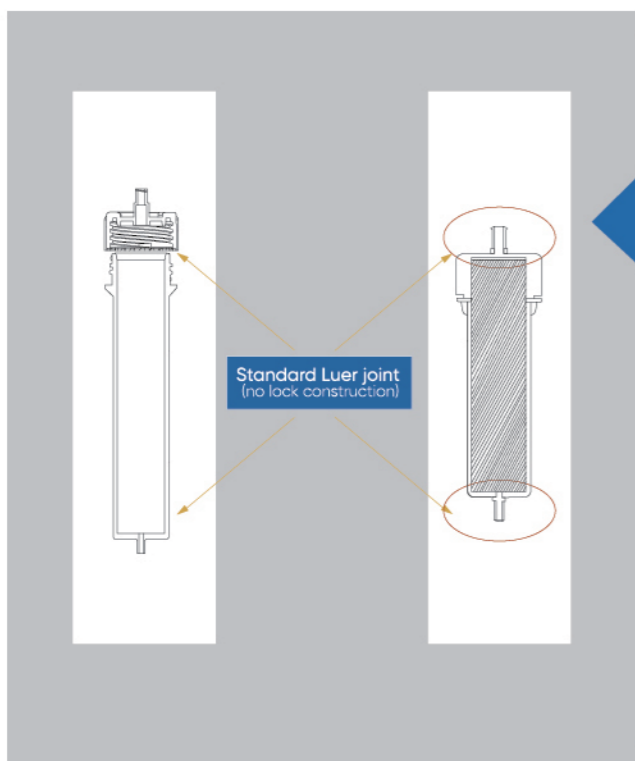

- 1 WelFlash SiO₂ LS medium and low pressure column is filled with high quality silica gel, which is cost-effective
- 2 Equipped with standard Luer connectors (non-locking structure)
- 3 Optimized packing process, high resolution, good reproducibility
- 4 Polypropylene tubes and connectors are designed with new technology to withstand up to 200psi with no leakage
- 5 Complete specifications, can be a variety of loading sizes, up to 1600g
- 6 Provide rich technical applications and complete solutions

Product performance test (good peak shape and separation performance):

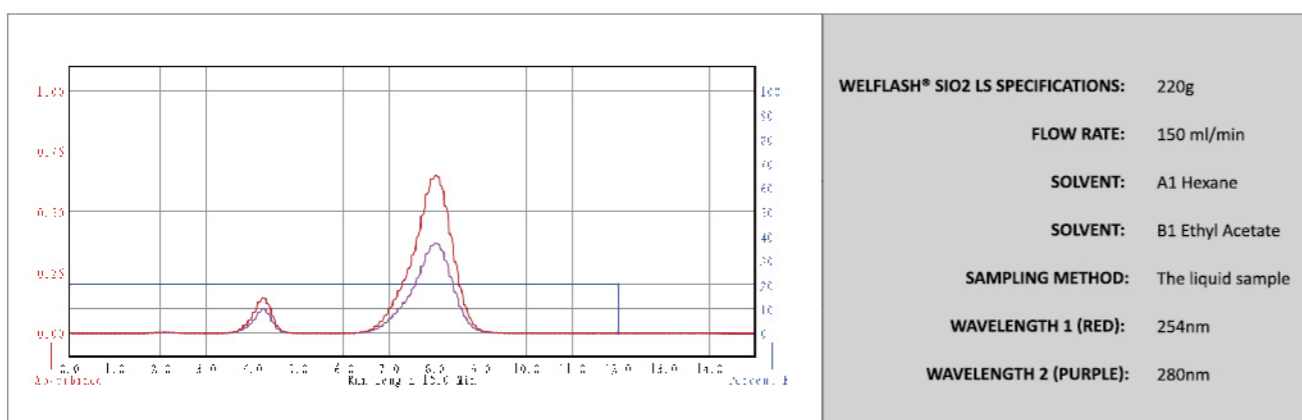

WelFlash cartridge Ordering Information

Amorphous silica gel:

P/N	Packaging Specifications
00101-05017	WelFlash SiO ₂ LS, 4g, 1/pk
00101-05027	WelFlash SiO ₂ LS, 12g, 1/pk
00101-05037	WelFlash SiO ₂ LS, 25g, 1/pk
00101-05047	WelFlash SiO ₂ LS, 40g, 1/pk
00101-05057	WelFlash SiO ₂ LS, 80g, 1/pk
00101-05067	WelFlash SiO ₂ LS, 120g, 1/pk
00101-05077	WelFlash SiO ₂ LS, 220g, 1/pk
00101-05087	WelFlash SiO ₂ LS, 330g, 1/pk
00001-05097	WelFlash SiO ₂ -II, 800g, 1/pk
00001-05107	WelFlash SiO ₂ -II, 1600g, 1/pk

Spherical 20-40µm silica gel:

P/N	Packaging Specifications
00001-03017	WelFlash SiO ₂ -I, 4g, 1/pk
00001-03027	WelFlash SiO ₂ -I, 12g, 1/pk
00001-03037	WelFlash SiO ₂ -I, 25g, 1/pk
00001-03047	WelFlash SiO ₂ -I, 40g, 1/pk
00001-03057	WelFlash SiO ₂ -I, 80g, 1/pk
00001-03067	WelFlash SiO ₂ -I, 120g, 1/pk
00001-03077	WelFlash SiO ₂ -I, 220g, 1/pk
00001-03087	WelFlash SiO ₂ -I, 330g, 1/pk
00001-03097	WelFlash SiO ₂ -I, 800g, 1/pk
00001-03107	WelFlash SiO ₂ -I, 1600g, 1/pk

Spherical 20-40µm C18:

P/N	Packaging Specifications
00002-03017	WelFlash C18-I, 4g, 1/pk
00002-03027	WelFlash C18-I, 12g, 1/pk
00002-03037	WelFlash C18-I, 25g, 1/pk
00002-03047	WelFlash C18-I, 40g, 1/pk
00002-03057	WelFlash C18-I, 80g, 1/pk
00002-03067	WelFlash C18-I, 120g, 1/pk
00002-03077	WelFlash C18-I, 220g, 1/pk
00002-03087	WelFlash C18-I, 330g, 1/pk
00002-03097	WelFlash C18-I, 800g, 1/pk
00002-03107	WelFlash C18-I, 1600g, 1/pk

Amorphous C18:

P/N	Packaging Specifications
00002-05017	WelFlash C18-II, 4g, 1/pk
00002-05027	WelFlash C18-II, 12g, 1/pk
00002-05037	WelFlash C18-II, 25g, 1/pk
00002-05047	WelFlash C18-II, 40g, 1/pk
00002-05057	WelFlash C18-II, 80g, 1/pk
00002-05067	WelFlash C18-II, 120g, 1/pk
00002-05077	WelFlash C18-II, 220g, 1/pk
00002-05087	WelFlash C18-II, 330g, 1/pk
00002-05097	WelFlash C18-II, 800g, 1/pk
00002-05107	WelFlash C18-II, 1600g, 1/pk

Spherical 40-70µm silica gel:

P/N	Packaging Specifications
00001-04017	WelFlash SiO ₂ -I, 4g, 1/pk
00001-04027	WelFlash SiO ₂ -I, 12g, 1/pk
00001-04037	WelFlash SiO ₂ -I, 25g, 1/pk
00001-04047	WelFlash SiO ₂ -I, 40g, 1/pk
00001-04057	WelFlash SiO ₂ -I, 80g, 1/pk
00001-04067	WelFlash SiO ₂ -I, 120g, 1/pk
00001-04077	WelFlash SiO ₂ -I, 220g, 1/pk
00001-04087	WelFlash SiO ₂ -I, 330g, 1/pk
00001-04097	WelFlash SiO ₂ -I, 800g, 1/pk
00001-04107	WelFlash SiO ₂ -I, 1600g, 1/pk

Spherical 40-70µm C18:

P/N	Packaging Specifications
00002-04017	WelFlash C18-I, 4g, 1/pk
00002-04027	WelFlash C18-I, 12g, 1/pk
00002-04037	WelFlash C18-I, 25g, 1/pk
00002-04047	WelFlash C18-I, 40g, 1/pk
00002-04057	WelFlash C18-I, 80g, 1/pk
00002-04067	WelFlash C18-I, 120g, 1/pk
00002-04077	WelFlash C18-I, 220g, 1/pk
00002-04087	WelFlash C18-I, 330g, 1/pk
00002-04097	WelFlash C18-I, 800g, 1/pk
00002-04107	WelFlash C18-I, 1600g, 1/pk

Spherical 20-40µm Phenyl:

P/N	Packaging Specifications
00003-03017	WelFlash Phenyl, 4g, 1/pk
00003-03027	WelFlash Phenyl, 12g, 1/pk
00003-03037	WelFlash Phenyl, 25g, 1/pk
00003-03047	WelFlash Phenyl, 40g, 1/pk
00003-03057	WelFlash Phenyl, 80g, 1/pk
00003-03067	WelFlash Phenyl, 120g, 1/pk
00003-03077	WelFlash Phenyl, 220g, 1/pk
00003-03087	WelFlash Phenyl, 330g, 1/pk

Spherical 20-40µm NH₂:

P/N	Packaging Specifications
00005-03017	WelFlash NH ₂ , 4g, 1/pk
00005-03027	WelFlash NH ₂ , 12g, 1/pk
00005-03037	WelFlash NH ₂ , 25g, 1/pk
00005-03047	WelFlash NH ₂ , 40g, 1/pk
00005-03057	WelFlash NH ₂ , 80g, 1/pk
00005-03067	WelFlash NH ₂ , 120g, 1/pk
00005-03077	WelFlash NH ₂ , 220g, 1/pk
00005-03087	WelFlash NH ₂ , 330g, 1/pk

Spherical 20-40µm SCX:

P/N	Packaging Specifications
00008-03017	WelFlash SCX, 4g, 1/pk
00008-03027	WelFlash SCX, 12g, 1/pk
00008-03037	WelFlash SCX, 25g, 1/pk
00008-03047	WelFlash SCX, 40g, 1/pk
00008-03057	WelFlash SCX, 80g, 1/pk
00008-03067	WelFlash SCX, 120g, 1/pk
00008-03077	WelFlash SCX, 220g, 1/pk
00008-03087	WelFlash SCX, 330g, 1/pk

Spherical 20-40µm C8:

P/N	Packaging Specifications
00013-03017	WelFlash C8, 4g, 1/pk
00013-03027	WelFlash C8, 12g, 1/pk
00013-03037	WelFlash C8, 25g, 1/pk
00013-03047	WelFlash C8, 40g, 1/pk
00013-03057	WelFlash C8, 80g, 1/pk
00013-03067	WelFlash C8, 120g, 1/pk
00013-03077	WelFlash C8, 220g, 1/pk
00013-03087	WelFlash C8, 330g, 1/pk

Spherical 20-40µm CN:

P/N	Packaging Specifications
00004-03017	WelFlash CN, 4g, 1/pk
00004-03027	WelFlash CN, 12g, 1/pk
00004-03037	WelFlash CN, 25g, 1/pk
00004-03047	WelFlash CN, 40g, 1/pk
00004-03057	WelFlash CN, 80g, 1/pk
00004-03067	WelFlash CN, 120g, 1/pk
00004-03077	WelFlash CN, 220g, 1/pk
00004-03087	WelFlash CN, 330g, 1/pk

Spherical 20-40µm SAX:

P/N	Packaging Specifications
00007-03017	WelFlash SAX, 4g, 1/pk
00007-03027	WelFlash SAX, 12g, 1/pk
00007-03037	WelFlash SAX, 25g, 1/pk
00007-03047	WelFlash SAX, 40g, 1/pk
00007-03057	WelFlash SAX, 80g, 1/pk
00007-03067	WelFlash SAX, 120g, 1/pk
00007-03077	WelFlash SAX, 220g, 1/pk
00007-03087	WelFlash SAX, 330g, 1/pk

Spherical 20-40µm AQ-C18:

P/N	Packaging Specifications
00012-03017	WelFlash AQ-C18, 4g, 1/pk
00012-03027	WelFlash AQ-C18, 12g, 1/pk
00012-03037	WelFlash AQ-C18, 25g, 1/pk
00012-03047	WelFlash AQ-C18, 40g, 1/pk
00012-03057	WelFlash AQ-C18, 80g, 1/pk
00012-03067	WelFlash AQ-C18, 120g, 1/pk
00012-03077	WelFlash AQ-C18, 220g, 1/pk
00012-03087	WelFlash AQ-C18, 330g, 1/pk

Spherical 20-40µm Diol:

P/N	Packaging Specifications
00014-03017	WelFlash Diol, 4g, 1/pk
00014-03027	WelFlash Diol, 12g, 1/pk
00014-03037	WelFlash Diol, 25g, 1/pk
00014-03047	WelFlash Diol, 40g, 1/pk
00014-03057	WelFlash Diol, 80g, 1/pk
00014-03067	WelFlash Diol, 120g, 1/pk
00014-03077	WelFlash Diol, 220g, 1/pk
00014-03087	WelFlash Diol, 330g, 1/pk

Alumina-N(neutral):

P/N	Packaging Specifications
00011-00017	WelFlash Alumina-N, 8g, 1/pk
00011-00027	WelFlash Alumina-N, 24g, 1/pk
00011-00037	WelFlash Alumina-N, 50g, 1/pk
00011-00047	WelFlash Alumina-N, 80g, 1/pk
00011-00057	WelFlash Alumina-N, 160g, 1/pk
00011-00067	WelFlash Alumina-N, 240g, 1/pk
00011-00077	WelFlash Alumina-N, 440g, 1/pk
00011-00087	WelFlash Alumina-N, 660g, 1/pk

Alumina-A(acid):

P/N	Packaging Specifications
00009-00017	WelFlash Alumina-A, 8g, 1/pk
00009-00027	WelFlash Alumina-A, 24g, 1/pk
00009-00037	WelFlash Alumina-A, 50g, 1/pk
00009-00047	WelFlash Alumina-A, 80g, 1/pk
00009-00057	WelFlash Alumina-A, 160g, 1/pk
00009-00067	WelFlash Alumina-A, 240g, 1/pk
00009-00077	WelFlash Alumina-A, 440g, 1/pk
00009-00087	WelFlash Alumina-A, 660g, 1/pk

Spherical 20-40µm PAH:

P/N	Packaging Specifications
00016-03017	WelFlash PAH, 4g, 1/pk
00016-03027	WelFlash PAH, 2g, 1/pk
00016-03037	WelFlash PAH, 25g, 1/pk
00016-03047	WelFlash PAH, 40g, 1/pk
00016-03057	WelFlash PAH, 80g, 1/pk
00016-03067	WelFlash PAH, 120g, 1/pk
00016-03077	WelFlash PAH, 220g, 1/pk
00016-03087	WelFlash PAH, 330g, 1/pk

Spherical 20-40µm HILIC Amide:

P/N	Packaging Specifications
00015-03017	WelFlash HILIC Amide, 4g, 1/pk
00015-03027	WelFlash HILIC Amide, 12g, 1/pk
00015-03037	WelFlash HILIC Amide, 25g, 1/pk
00015-03047	WelFlash HILIC Amide, 40g, 1/pk
00015-03057	WelFlash HILIC Amide, 80g, 1/pk
00015-03067	WelFlash HILIC Amide, 120g, 1/pk
00015-03077	WelFlash HILIC Amide, 220g, 1/pk
00015-03087	WelFlash HILIC Amide, 330g, 1/pk

Alumina-B(basic):

P/N	Packaging Specifications
00010-00017	WelFlash Alumina-B, 8g, 1/pk
00010-00027	WelFlash Alumina-B, 24g, 1/pk
00010-00037	WelFlash Alumina-B, 50g, 1/pk
00010-00047	WelFlash Alumina-B, 80g, 1/pk
00010-00057	WelFlash Alumina-B, 160g, 1/pk
00010-00067	WelFlash Alumina-B, 240g, 1/pk
00010-00077	WelFlash Alumina-B, 440g, 1/pk
00010-00087	WelFlash Alumina-B, 660g, 1/pk

Spherical 20-40µm Xtimate:

P/N	Packaging Specifications
00018-03017	WelFlash XT-C18, 4g, 1/pk
00018-03027	WelFlash XT-C18, 12g, 1/pk
00018-03037	WelFlash XT-C18, 25g, 1/pk
00018-03047	WelFlash XT-C18, 40g, 1/pk
00018-03057	WelFlash XT-C18, 80g, 1/pk
00018-03067	WelFlash XT-C18, 120g, 1/pk
00018-03077	WelFlash XT-C18, 220g, 1/pk
00018-03087	WelFlash XT-C18, 330g, 1/pk

Spherical 20-40µm C4:

P/N	Packaging Specifications
00017-03017	WelFlash C4, 4g, 1/pk
00017-03027	WelFlash C4, 12g, 1/pk
00017-03037	WelFlash C4, 25g, 1/pk
00017-03047	WelFlash C4, 40g, 1/pk
00017-03057	WelFlash C4, 80g, 1/pk
00017-03067	WelFlash C4, 120g, 1/pk
00017-03077	WelFlash C4, 220g, 1/pk
00017-03087	WelFlash C4, 330g, 1/pk

PS/DVB:

P/N	Packaging Specifications
00030-10017	WelFlash PS/DVB, 4g, 1/pk
00030-10027	WelFlash PS/DVB, 12g, 1/pk
00030-10037	WelFlash PS/DVB, 25g, 1/pk
00030-10047	WelFlash PS/DVB, 40g, 1/pk
00030-10057	WelFlash PS/DVB, 80g, 1/pk
00030-10067	WelFlash PS/DVB, 120g, 1/pk
00030-10077	WelFlash PS/DVB, 220g, 1/pk
00030-10087	WelFlash PS/DVB, 330g, 1/pk

WeFlash® Cartridge Selection Guide:

SiO ₂ (pH 1.5-10.0)	Spherical silica gel 20-40µm Spherical silica gel 40-70µm Amorphous silica gel	1. With spherical silica packing materials and amorphous silica packing materials (purity > 99.999%) two substrates, to meet the different needs of customers. 2. Low acidity and low metal content. 3. Both normal-phase and reverse-phase modes can be used, especially for the separation and purification of polar compounds. 4. With standard Luer-Lok liquid inlet and Luer-Slip liquid outlet, it is compatible with various fast liquid preparative chromatography systems.	Permethrin emulsion, cypermethrin, etc
NH ₂ (pH 2.0-8.0)	Spherical NH ₂ 20-40µm	1. For normal phase, reverse phase, weak anion exchange mode, typical separation of various monosaccharides under reverse phase conditions, separation of polar compounds under normal phase elution conditions, tocopherols and some soluble in alkanes, alkenes, and aromatics Organic compounds in hydrocarbons. 2. In low pH buffer solution, it is weak anion exchange, which can separate some negatively charged molecules.	Allene Phosphate, D-Tagatose, D-Galactose Isolation, N-Acetyl Glucose, D-Ribose, Acetyl-L-Carnitine, Chitooligosaccharide, N-Acetyl Glucose, Ornithine Aspartate, Arginine separation of fumaric acid, ornithine aspartate raw material, potassium aspartate, levocarnitine, allantoin aluminum, lactulose, acarbose, lactose, ascorbic acid, cisplatin, monosialic acid tetra Hexosylganglioside sodium, glycerin in hydroxyglycoside eye drops, sucralfate, iodixanol, sugar inversion solution, fosfomycin tromethamine EP7, Korean red ginseng, aminotoluic acid, selenium polysaccharide, pyrrole Alkyl hydrochloride, Sophora flavescens, etc.
Diol (pH 2.0-8.0)	Spherical 20-40µm	1. Compared with silica normal phase column and amino normal phase column, it has better stability and reproducibility. Further modification on the basis of pure silica gel can provide better selectivity and chromatographic peak shape for some compounds. 2. The unique bonding technology ensures the stable structure of the stationary phase, and the strict process ensures excellent batch reproducibility. 3. High column efficiency and long service life.	Ibuprofen sodium chloride, propofol, arginine, tacrolimus, dexpropramide, etc
SCX (pH 2.0-8.0)	Spherical 20-40µm	1. It is Welch's classic cation exchange column with high purity silica matrix and aromatic sulfonic acid group as the bonding phase. It is used for basic and water-soluble compounds. 2. Applications include organic bases such as basic amino acids, anilines, medicinal salts, inorganic cations and nucleotides.	Metformin hydrochloride, acetyl cysteine acetyl tyrosine, betel nut, tromethamine, Leonine, melamine, meglumine, micuramine, etc
WCX	Amorphous WCX	Weak cation exchange column of silica matrix, bonding carboxyl functional group.	It is commonly used in the separation and purification of quaternary ammonium compounds or other strong cations.
Alumina-N (Neutral)		1. The adsorption capacity of alumina is usually stronger than the adsorption capacity of silica gel, silica gel has a larger sample processing capacity, so it is suitable for the separation of lipophilic components. 2. Ordinary silica gel is difficult to deal with alkaline substances, can use neutral alumina treatment. The pH of the aqueous extract was 7.5.	It is suitable for the separation of aldehydes, ketones, quinones, some glycosides and compounds that are unstable in acid-base solutions, such as esters and lactones.
Alumina-B (Alkaline)		1. Alumina adsorption capacity is usually stronger than the adsorption capacity of silica gel, silica gel has a larger sample processing capacity, so it is suitable for the separation of lipophilic components. Ordinary silica gel is difficult to handle alkaline material, can use neutral alumina treatment. The pH of the aqueous extract is 9-10.	The separation of hydrocarbon compounds can remove oxidizing compounds from hydrocarbon compounds. It can separate some pigments, sterol compounds, alkaloids, alcohols and other neutral and basic substances.
Alumina-A (Acid)		1. Alumina adsorption capacity is usually stronger than the adsorption capacity of silica gel, silica gel has a larger sample processing capacity, so it is suitable for the separation of lipophilic components. Ordinary silica gel can not handle the alkaline material, can use acid alumina treatment. The pH of the aqueous extract is 4-4.5.	Separation of natural and synthetic acid pigments and certain aldehydes and acids.
PS/DVB (pH 1.0-14.0)		Specially designed for efficient separation, it is a new type of reversed-phase chromatography packing materials with high chemical and physical stability. It uses highly cross-linked polystyrene/styrene (PS/DVB) particles with extremely narrow particle size and pore size distribution as matrix. It overcomes the limitation of narrow pH range of silica gel packing materials, and can be used under extreme pH(1.0-14.0) conditions. The column efficiency can be almost unchanged by changing different organic solvents.	Suitable for the separation and purification of proteins, peptides, oligonucleotides, antibiotics and small molecule drugs, doxycycline hydrochloride, sucralose.
Phenyl (pH 1.5-10.0)	Spherical Phenyl 20-40µm	1. The use of ultra-pure porous spherical silica gel, purity > 99.999%, more uniform pore size. 2. Unique fixed phase bonding, double endcapped technology, make peak shape symmetry better. 3. Lower UV and MS loss; The high surface coverage increases the chemical stability of the bonded phase. 4. With straight alkane chain is not the same selectivity, aromatic compounds, polar compounds have excellent separation performance.	For injection, Yanhuning, Montelukast sodium, moxifloxacin hydrochloride, tetracycline, fiteconazole nitrate, Raphani, hydroxypropyl betacyclodextrin, etc.

CN (pH 1.5-9.0)	Spherical CN 20-40µm	1. Applicable to substances that do not retain or retain too strongly on C18. 2. It shows different selectivity compared with C18 when used as reverse phase. Rapid elution of hydrophobic molecules under reversed-phase conditions, unique selectivity for polar compounds, and good peak shape for the separation of strongly basic compounds (including ammonium salts), suitable for common reversed-phase C18 and C8 columns Strongly hydrophobic samples that are difficult to elute. 3. In normal phase chromatography, cyano bonded phase can replace silica gel, which has the characteristics of faster equilibrium and more consistent surface activity than non-bonded silica gel.	Esmolol Hydrochloride, Olanzapine, Oxiracetam, Dihydralazine Sulfate, Trilagliptin, Azocarboxamide, Octagliptin, Hydralazine Hydrochloride, Anchordine Hydrobromide, oxybenzidine and impurity B, new Lilstat, carbamazepine, compound diphenoxylate, ciclopirox amine, etc.
HILIC Amide (pH 2.0-8.0)	Spherical 20-40µm	The separation mechanism is similar to that of HILIC-NH ₂ and has unique selectivity.	L-L-carnitine, azetidine-3 carboxylic acid, vitamin C, etc.
C18 (pH 1.5-10.0)	Spherical C18 20-40µm Spherical C18 40-70µm Amorphous C18	1. Welch Materials is one of the flash cartridges with the strongest separation performance and universality. 2. Classic "star" product, excellent performance, extremely stable stationary phase, batch tracking can be realized, with perfect reproducibility, can be used as your first choice for conventional methods.	Saponins, flavonoids, polyphenols, pesticide residues, hormones, Chinese herbal medicines.
C8 (pH 1.5-10.0)	Spherical 20-40µm	1. High surface coverage and unique double endcapped process with good peak shapes for acidic, basic and neutral compounds. 2. Classical reverse-phase packing materials with slightly weaker retention than C18 are recommended for the separation of strongly hydrophobic compounds.	Diketone phthalazine, insulin detemir, tachlimus, Adefovir dipivoxil, phenobarbital, clindamycin phosphate for injection, finasteride, Ganesurium, Rifapentine, Betahistine hydrochloride, rifampin, Esomeprazole magnesium, piropidol hydrochloride, fluvoxamine maleate, oxiracetam, Piropidone hydrochloride, etc.
C4 (pH 1.5-10.0)	Spherical 20-40µm	1. It has strong retention ability for hydrophobic and polar compounds, unique bonding technology and high bonding phase coverage. 2. The unique dual endcapped technology maximizes the elimination of residual silicon hydroxyl groups, with excellent peak shape for the separation of basic and strongly polar compounds. It is a recommended bonding phase for substances that do not retain well on conventional C8 and C18.	Albumin, ethinyl estradiol, etc.
AQ-C18 (pH 1.5-10.0)	Spherical 20-40µm	Cephalosporins, water-soluble vitamins, pefloxacin mesylate, decitabine, cimetidine, diosmin, docetaxel, levamlodipine besylate, sodium lactate, abamectin, rifaximin, acyclovir, disodium cytidine triphosphate for injection, tartaric acid, metoprolol tartrate, oxiracetam, iopromide, geniposide, biotin, letrozole, Puhuang, Telbivudine, Sucralose, MOC-tert-Leucine, Cocarboxylase Tetrahydrate, Flunarizine Hydrochloride, 4-(Methylhydroxyphosphoryl)-2-carbonyl-butyric acid, Fluorine Relax, Prednisolone, Taurine, Isoniazid.	1. Resistance to 0%-100% water phase. 2. Dual endcapped technology. 3. Moderate carbon load. 4. Low bond density of alkyl chain. 5. Moderate retention capacity. 6. The adsorption capacity of impurities is weaker than XB-C18. 7 is the chemical content determination, food industry's leading pillar.
Xtimate C18 (pH 1.5-12.5)	The spherical alkali C18 20-40µm	1. The silicone matrix is modified by Welch's patented organic and inorganic hybrid surface technology, which can be separated and purified in a wide pH range, with a variety of mobile phase systems and a wide temperature range. 2. Under the most demanding conditions, it also has very stable performance and longer life. It has longer life than ordinary C18 under conventional experimental conditions. Using advanced and innovative technology for production and quality control according to stringent quality standards is a trusted solution for your difficult-to-separate projects.	The preferred column for mobile phase pH over 8.0, the best choice for alkaline substances, Achyranthos serrata, Chlorpheniramine maleate, Dihydroergotoxin mesylate, Levofloxacin, Calcium folinate, Imipenem, An Najin Tablets, Pantoprazole Sodium, Meropenem, Betahistine Hydrochloride, Procaine Hydrochloride, Sertraline Hydrochloride Trans-isomer, Promethazine Hydrochloride, Moxifloxacin Hydrochloride Isomer, Phenolamine Gamin Granules, Solifenacin Succinate, Octreotide Acetate, Dexamethasone Acetate, Sodium Phosphate Creatine, Piperacillin Sodium Tazobactam Sodium, Rabepazole Sodium, Rosuvastatin Calcium, Esomeprazole Sodium azole, compound tetrazine reserpine, steroids, gabapentin, clopidogrel sulfate, adenosyl cobalt ammonium for injection, biguanide trioctane phenyl sulfonate, 3-aminocrotonitrile, calcium folinate, naked Flower purple, beaded salmon calcitonin, suramin sodium, folic acid, sodium nitroprusside for injection, etc.
PAH (pH 1.5-10.0)	Spherical 20-40µm	It is suitable for the efficient separation of 16 PAHs in ERA method 610.	Separation of Polycyclic Aromatic Hydrocarbons Mixtures.
SAX (pH 2.0-8.0)	Spherical 20-40µm	A polarbonded packing material, composed of ammonium functionalized silane, was used for efficient anion exchange.	Applicable to the pesticide, herbicide, pharmaceutical, inorganic anions and biological samples (e.g., nucleotides and thioglycoside), organic acids, such as the separation of aromatic and aliphatic carboxylic acid and sulfonic acid, terephthalic acid, sodium chondroitin sulfate, deoxyribonucleotide sodium for injection, iminodiacetic acid, heparin disaccharide, acid dyes, azole phosphonic acid, EDTA, etc.

SEPARATION Mode Selection Guide



05

PURIFICATION SOLUTIONS

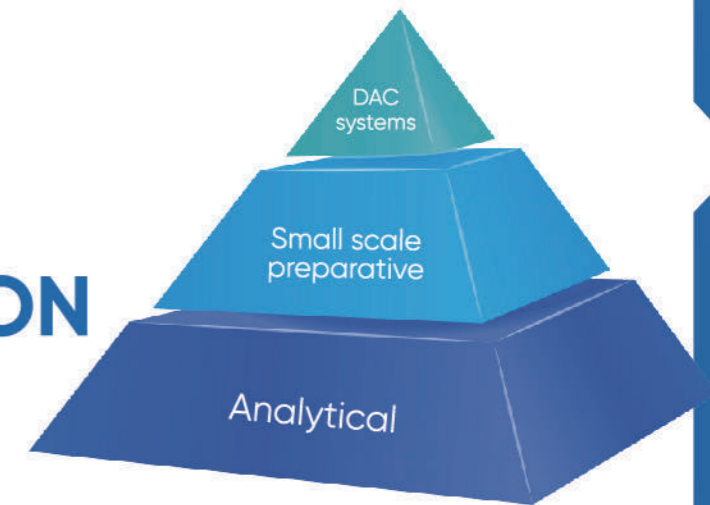

APPLICATION of Peptides Purification

A customer has provided crude polypeptide products, requiring the separation of a relatively large impurity peak in front of the main peak, the required purity is more than 95%, the required recovery rate is greater than 90%.

According to the sample characteristics and experimental conditions, Welch carries out the bond phase exporing test.



Choose Welch Materials

to save you time in method development!

Choose Welch Materials

to obtain purification technical support!

Choose Welch Materials

to improve production efficiency!

First, test on the analytical column:

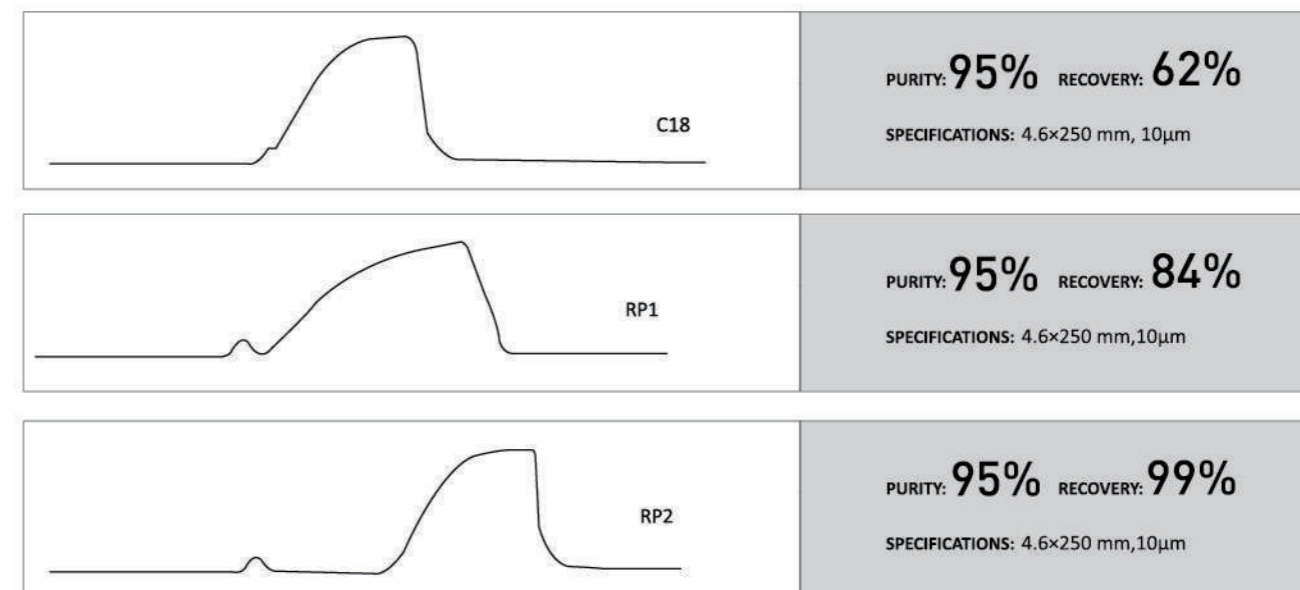

From the experiment above , RP2 packing materials was chosen:

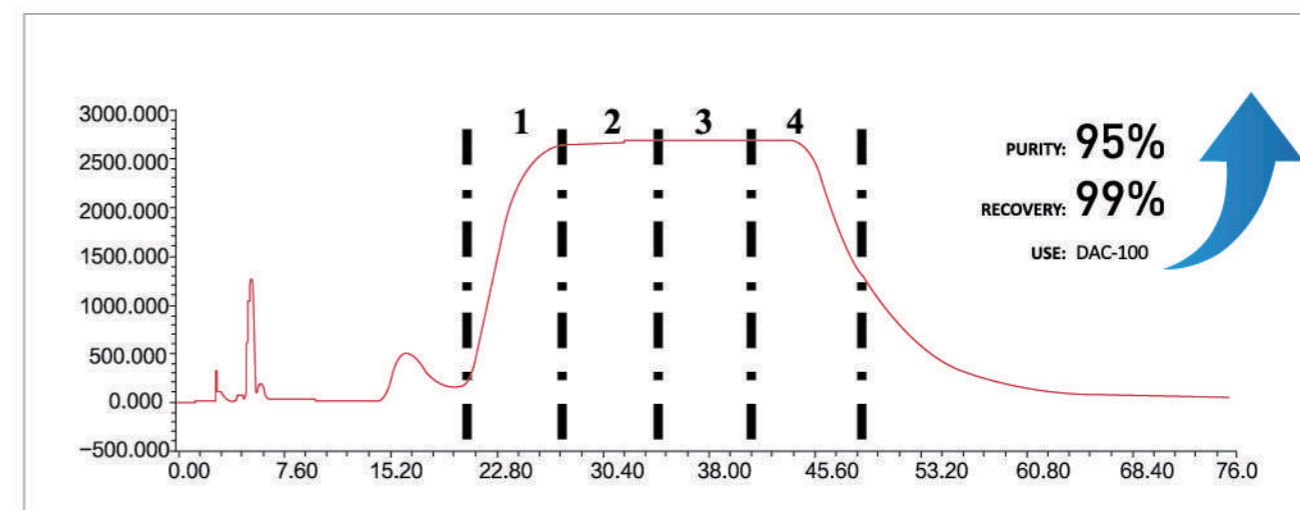

Through the previous tests, Welch Materials selected the appropriate packing materials for the customer, and the customer purchased them for the large-scale production of the polypeptide drug, which not only saved the production time, but also reduced the production cost by 30%.

SEPARATION and Purification Solutions



Separation and purification solutions

According to the problems encountered by customers in the actual experiment and production, we can develop and optimize the existing experimental conditions for customers according to the experimental purpose, so as to improve the work efficiency and increase the yield for you.



Professional customized services

According to the properties of the sample provided by the customer and the requirements of the customer, we will develop suitable packing materials for the customer. Special specifications of the column tube can also be customized.



Purification equipment recommendation

For your equipment selection to provide a full range of technical support, especially for the customer who is not familiar with separation and purification technology, our professional technical guidance will make your equipment selection work twice the result with half the effort.

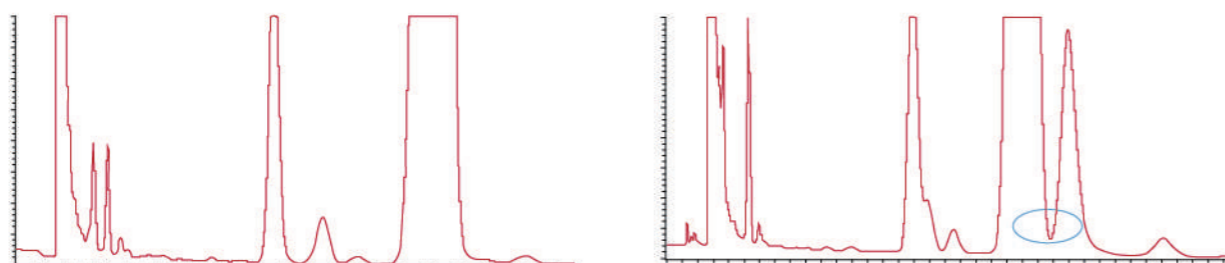

*Optimize the experimental conditions to effectively separate impurities.

