

# INSTRUCTIONS

## Install the software

Download and install the engraving software (LightBurn). Before engraving, you can use the camera's calibration function. Follow the file in the TF card - "Camera Calibration and Alignment".

## Make an engraving picture

Find the picture you want to engrave. The higher the resolution, the clearer the picture.

## Set parameters

Set the parameters for engraving. Please refer to the file in the TF card - "Parameter Recommendation". The specific operation can be carried out according to the prompts of the engraving software, or check the file in the TF card - "Software Operation Tutorial".

## Start engraving

Activate , waiting for the new work to appear.

## Product assembly

View the product installation steps in the manual to assemble the product. You can also refer to the video in the TF card information package - "Assembly Instructions".

## Adjust the focus

Place the engraving material and use the multi-level fixed focus block to focus, connect the computer and device to start our journey.

## G-Code for the first creation

Use the "G-code" file provided in the TF card to connect the device to engrave the first work, which can test the structural stability of the device. Before engraving, please use the Frame to adjust the engraving position.

Back up the files of TF card to the computer and then clear the TF card for subsequent operations, put the "G-Code" corresponding to the power into the TF card.

Insert the TF card into the card slot. Use the Frame to adjust the position of the engraving material.

Start and look forward to the work.



## Thank You Note

*Dear Users,*

*Thank you for choosing Creality Falcon. For your convenience, read this manual carefully before using, and Please follow the instructions. On this journey, we look forward to the endless possibilities you create. You can also share your works on Creality's social media platform and learn from each other.*

*Creality team is always here to provide you with quality services. If you encounter problems during use, please contact us by phone or email according information provided at the end of the manual.*

*Besides, video instructions are available on the TF card for your reference. You can also visit Creality's official website ([www.cxsw3d.com](http://www.cxsw3d.com)) to learn more about software and hardware, contact, operation, maintenance, etc.*

Instructions

Thank You Note

|                       |    |
|-----------------------|----|
| 01 Security Statement | 5  |
| 02 Packing List       | 6  |
| 03 Assemble           | 9  |
| 04 Product Structure  | 21 |
| 05 Specifications     | 22 |
| 06 Laser Module       | 23 |
| 07 Operation          | 25 |
| 08 FAQ                | 27 |
| 09 Troubleshooting    | 28 |

## 01 SECURITY STATEMENT

When a laser engraver engraves or cuts materials, it casts high-density laser beam that heats the surface to vaporize materials without burning them. But most materials are inherently flammable and can be ignited, which may burn the device and the surroundings.

### Warning:

1. Do not place the device near flammable and explosive materials, volatile solvents or heat sources. Please place the device in a ventilated, cool and dust-free environment;
2. Please use the adapter and power cord provided with the device;
3. Regularly clean the body and laser module with an anti-static brush or a dry cloth when the device is powered off;
4. Please connect the silicone tube on the laser module no matter using an air assist or not. Otherwise, there will be a risk of lens contamination;
5. The working temperature of the power adapter is 5°C-35°C. Avoid using this product in a humid environment, and do not use it in thunderstorm weather;
6. If the device isn't used for a long time, please turn off the device and disconnect the power cord;
7. When the device is connected to the power supply, please do not touch the electronic areas with your hands or other tools. It is forbidden to plug and unplug the laser module cable when the device is powered on;
8. When the device is running, please do not touch any part of the moving system and laser module;
9. When working, do not look directly at the laser and wear goggles to protect your eyes;
10. Smoke or smell may be produced during laser engraving and cutting. It is recommended to operate in a well-ventilated environment;
11. Children please operate under adult supervision;
12. Have a fire extinguisher ready just in case. Regularly maintain and inspect fire extinguishers;
13. It is forbidden to leave it unattended while the device is working;
14. Users should abide by the laws and regulations of the corresponding country and region where the equipment is located (where it is used), practice professional ethics and pay attention to safety obligations. It is strictly forbidden to use our products or equipment for any illegal purposes. If there is any violation, we will not be responsible for the relevant legal responsibilities;
15. Please clean the tray promptly and do not accumulate debris.



Use of controls or adjustments or performance of procedures other than those specified herein may result in hazardous radiation exposure. The laser safety classification of this product follows IEC 60825-1:2014. The laser safety level of laser radiation emitted through laser aperture exceeds level 1.

## 02 PACKING LIST



Aluminum Strip A(FAN)



Aluminum Strip B(Light)



Top Support Bar



Countersunk Head Screws\*10



Transparent Film



Bottom Support Bar



Sheltering Cover



Light Panel



The Principal Part



Laser Module



Board A



Board B



Oval Head Screws \*26



Exhaust Pipe



Clamp



Air Assist Equipment



Silicone Tube

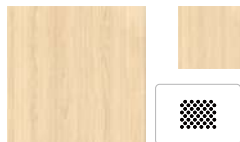

Basswood\*1 (300\*300\*3mm)  
Basswood\*1 (150\*150\*2mm)  
Calibration Card



Power Supply



Goggles



Multi-level Fixed Focus Block    USB-C Cable \*2    Anti-static Brush  
USB-A to USB-C adapter    M4 Allen Wrench



User Manual



Creality Stickers

Assembly Box



M1.5 / M2 / M2.5 / M3  
Allen Wrench



Open-end  
Wrench



Tweezers



Dust-free Cloth



Protective  
Len



USB-A to USB-C  
adapter



Velcro Strap\*3



Key\*2



TF Card



Card  
Reader

Optional



Smoke Purifier



Rotary Kit



Risers



## 03 ASSEMBLE

- 1 Identify the front and back sides of aluminum strips A and B.

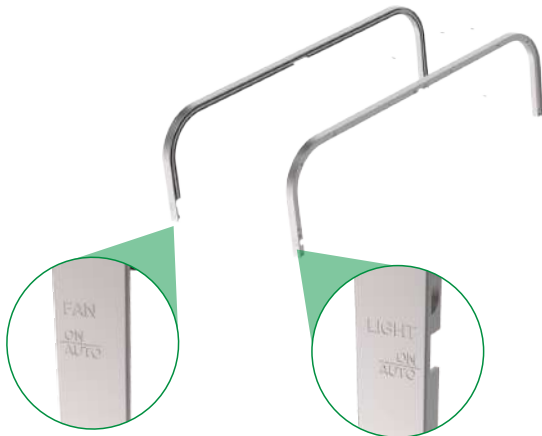

Aluminum Strip A (FAN)

Aluminum Strip B (Light)

- 2 Use the top support bar to connect aluminum strip A and aluminum strip B; lock them with countersunk head screws.

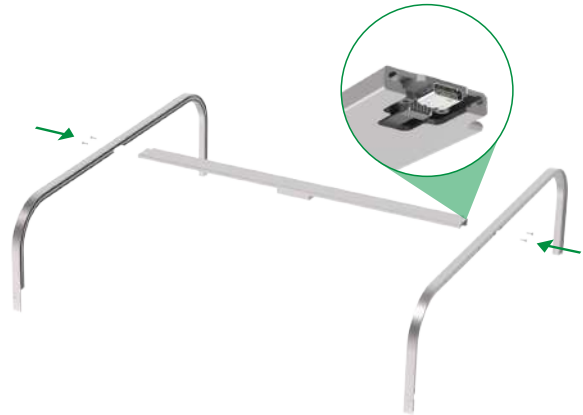

- 3 Determine the front and rear directions of the protective frame.

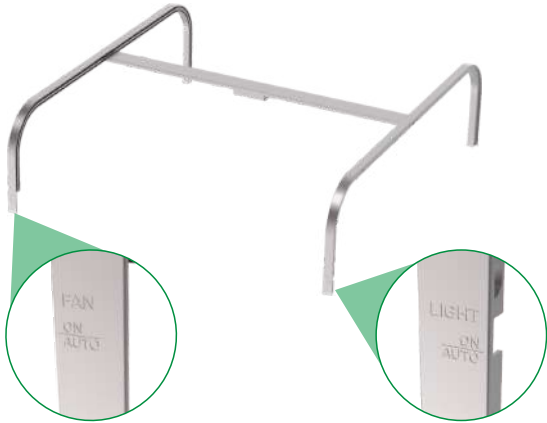

Aluminum Strip A (FAN)

Aluminum Strip B (Light)

- 4 Slide the transparent film from the back through track 1 into the frame.

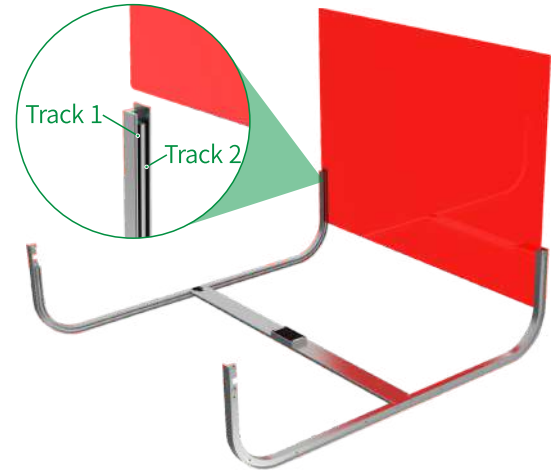

5 During sliding, pay attention to the position of the corners.

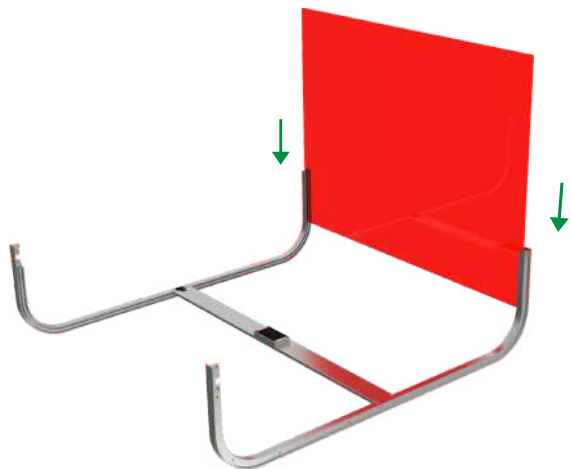

6 Continue sliding forward along the track.

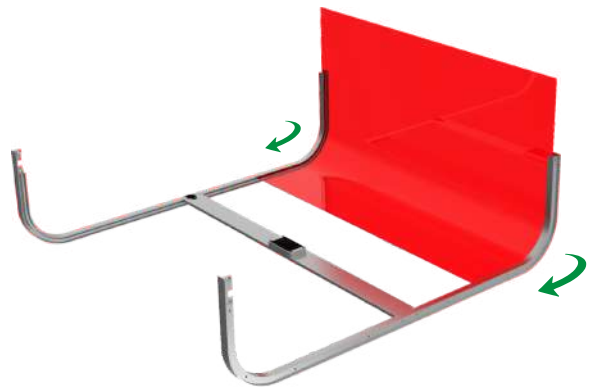

- 7 Slide the transparent film onto the top support strip.

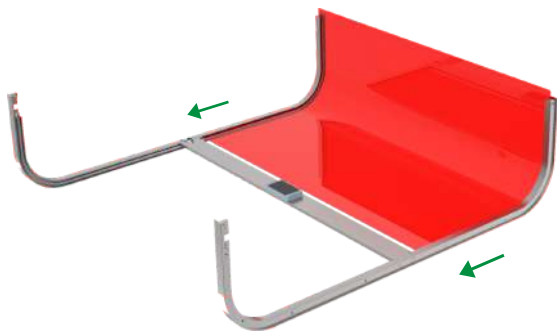

- 8 Snap the film into the top support bar.

Snap the film into the top support bar

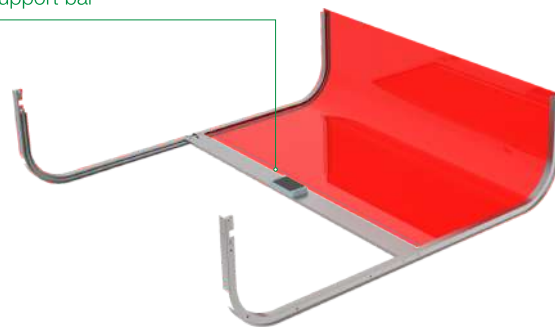

- 9 And connect the bottom support bar to the transparent film according to the track. Then tighten with countersunk head screws.



- 10 Slide the sheltering cover from the front track 2 into the frame.

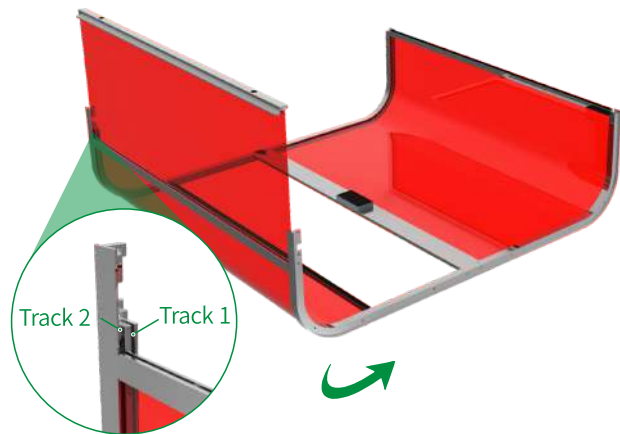

11 Use countersunk head screws to install the light panel.

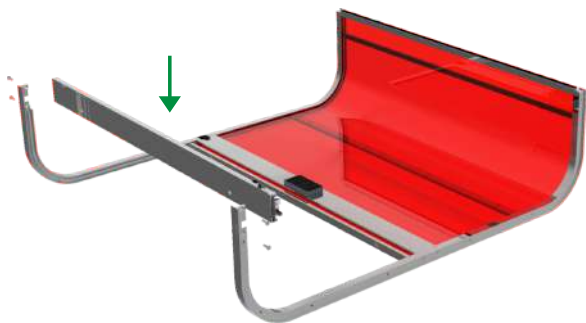

12 Install the laser module on the principal part of the device.



- 13 Connect the silicone tube, paying attention to the position of the connection.



- 14 Put the cables into the buckle, and then use velcro straps to organize the cables.



- 15 Tighten the screws of the laser module.



- 16 Put in aluminum slats to make honeycomb panels.

Method 1





Method 2



- 17 Connect the assembled protective frame to the principal part of the device, and lock board A with round head screws.



18 Lock board B with round head screws.

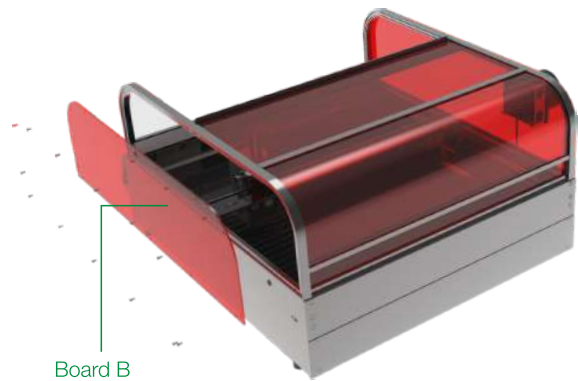

19 Connect the fan and light panel cables to the principal part.

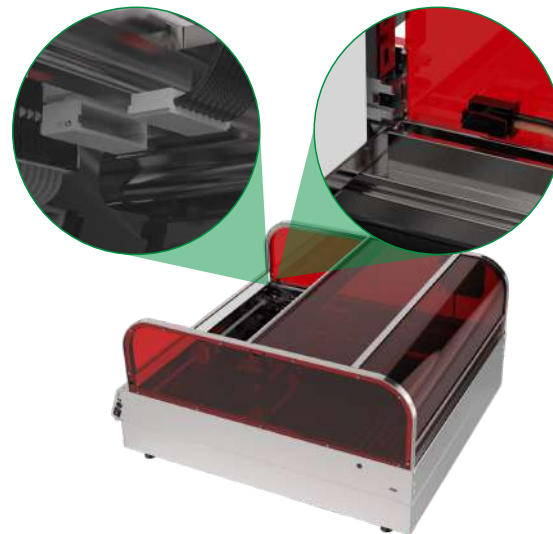

20 Install the exhaust pipe and tighten it with clamp.

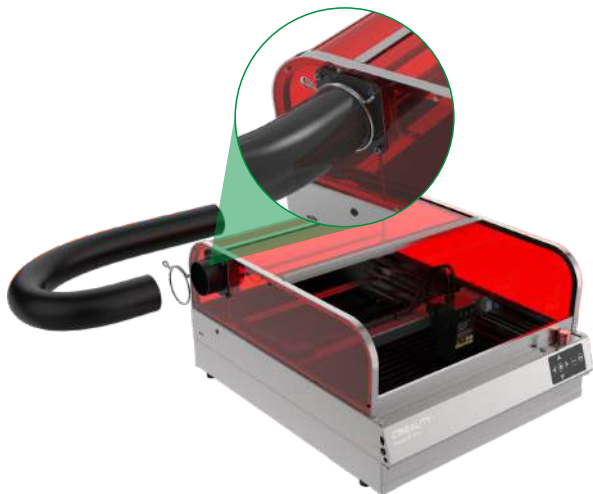

21 Connect the air assist equipment and install the silicone tube.

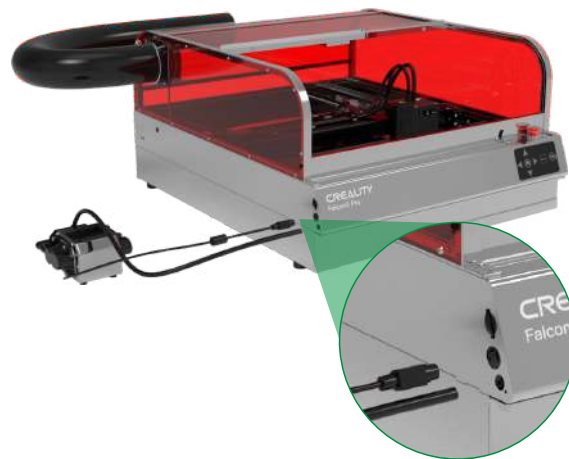

22 The position of connecting silicone tube.

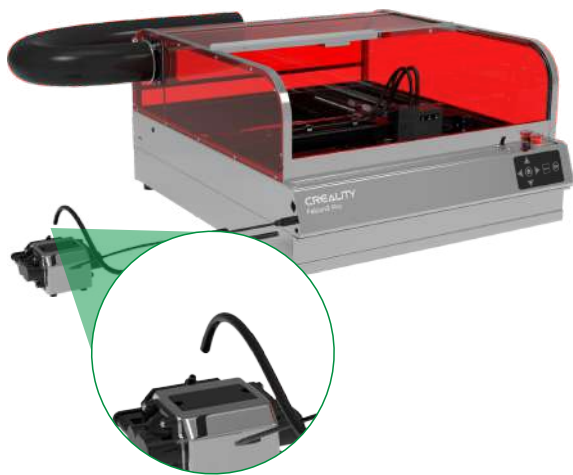



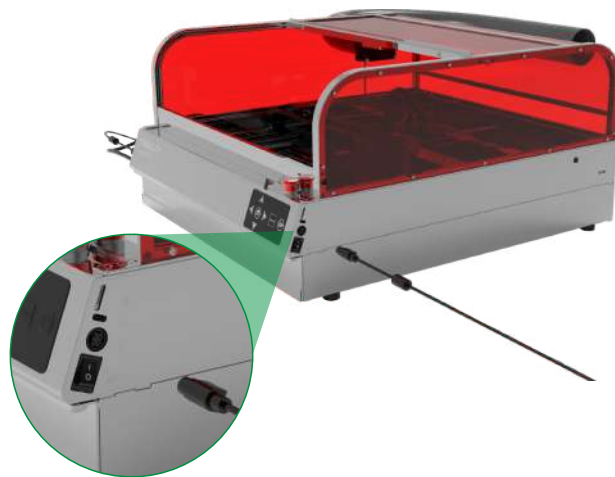

23 Connect the power supply.

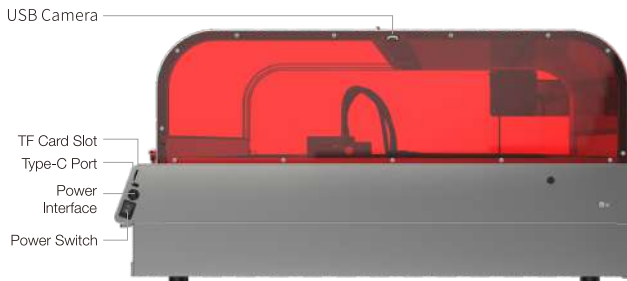
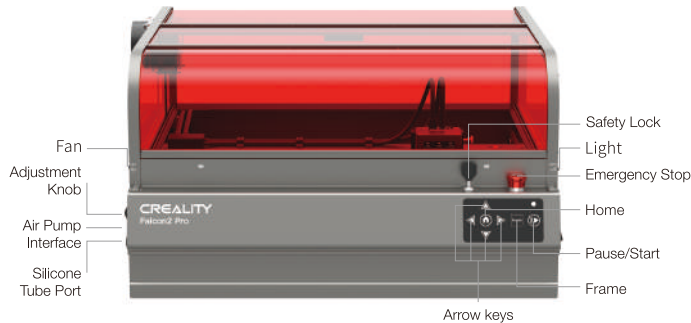

## 04 PRODUCT STRUCTURE



|   |   |
|---|---|
| Safety Lock   | One of the triple safety switches.  |
| Emergency Stop  | One of the triple safety switches - emergency power off   |
| Power switch  | One of the triple safety switches - daily work switch.  |
|  | The laser module can be moved in standby or preview state. Each press will move 1mm. Press and hold to make the beep and then move 10mm.  |
|  | In standby mode, return the laser module to zero (i.e. return to the lower left corner).  |
|  | In standby or preview mode, when using a TF card for offline work, enter or exit the frame preview mode (that is, make repeated movements around the maximum X/Y range of the pattern). |
|  | In preview or working state, press the button once to pause or resume work, press and hold for 3 seconds to cancel the current work.  |
| TF Card Slot  | Insert a TF card with "G-code" to work offline for engraving or cutting works.  |
| Type-C Port   | Connect computers and devices.  |
| Power Interface   | Connect to the power supply for power supply.   |
| USB Camera  | Connect computer and camera.  |
| Adjustment Knob   | Adjust the air flow of the air pump.  |
| Air Pump Interface  | Connect the air pump to the device for power supply.  |
| Silicone Tube Port  | Connect the air pump to the equipment to transmit air flow.   |
| Fan, Light  | In AUTO mode, it operate with the machine, in ON mode, it run continuously when powered.  |

## ⚠ Warning Light

1. Didn't Light Up: The device is in a power-off state, or some abnormality occurs.
2. Solid white: The device is in the initialization mode, and it will automatically enter the standby mode after the initialization is completed.
3. Flashing Red Light: The red light flashes twice, indicating that the sealing state is broken and the preview mode fails to be entered; When the red light keeps flashing, the device is in abnormal mode and the buzzer makes a rapid sound. It will automatically enter standby mode after the abnormality is cleared. For example, in the working state, the equipment rolls over, the confined space is destroyed, the laser module is abnormal, etc.
4. Green Gradient Light: The device is in standby mode, and you can press Frame button to enter preview mode.
5. Solid blue: The device is in preview mode or engraving mode, and the laser module is emitting a beam. Special attention should be paid to safety.
6. Flashing Yellow light: Couldn't read G-Code file in the TF card, and the buzzer will sound twice.
7. Flashing Purple Light: The device is in the firmware upgrade mode, and the buzzer makes a rapid sound at the same time. It will automatically enter the standby mode after the upgrade is completed.

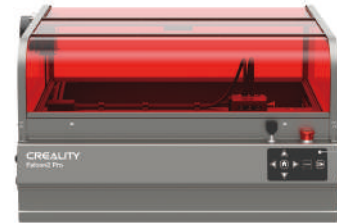

Warning Light

## 05 SPECIFICATIONS

|                       |  |                 |                 |                          |  |
|-----------------------|--|-----------------|-----------------|--------------------------|--|
| Product Name          | Creality Falcon2 Pro Laser Cutter and Engraver     |                 |                 | Engraving Area           | 400mm*415mm  |
| Optical Power         | 22W  | 40W             | 60W             | Laser Source             | Diode Laser  |
| Product Size          | 664*570*328.4mm                                    | 664*570*328.4mm | 664*570*328.4mm | Laser Wavelength         | 455±5nm  |
| Weight                | 18.16kg  | 19kg            | 19.51kg         | Laser Class              | Class 1 (FDA)  |
| Input Voltage         | 100-240V~ 50-60Hz                                  |                 |                 | Laser Engraving Software | LightBurn、LaserGRBL  |
| Output Voltage        | DC 24.0V 5.0A                                      | DC 24.0V 10.0A  | DC 24.0V 15.0A  | Operating System         | Windows/MacOS  |
| Working Temperature   | 5°C-35°C   |                 |                 | Supported File Formats   | jpeg, jpg, png, bmp, svg, dxf etc.                                       |
| Safety Certifications | IEC60825, FDA, CE, ROHS, FCC, UKCA, UL Report, PSE |                 |                 | Supported Materials      | Cardboard, wood, bamboo, rubber, leather, fabric, acrylic, plastic, etc. |

## 06 LASER MODULE



**Power:** Indicates powered on.

**Laser:** Shows that the laser emits a normal beam.

**Silicone Tube Port:** Connect air pump to pass air flow.

**Type-C:** Connect TF card to upgrade firmware, equipped with TF card reader and A to C adapter.

**Reset:** Use it to clear the alarm information after alarming; another situation is for the 60W or 40W power laser module, doing a long press to switch three modes - 60W,40W,22W.

**Precise:** If only this light is on, it means that the current mode is precise, the maximum light power is 22W, the engraving effect is more delicate, and the cutting gap is smaller.

**Normal:** The two lights are on, which means it is in Normal. The maximum optical power is 40W, which can cut thicker materials and the cutting speed is faster.

**Powerful:** Three lights are on, which means it is in Powerful. The maximum optical power is 60W, which means it can cut thicker materials and the cutting speed is faster.

### Notes:

1. The alarm function of the laser module is turned on by default and can be turned off manually. When the alarm function is turned off, the indicator light will still indicate the current situation normally. Please refer to the "Laser Module Alarm Functions" in the TF card.
2. When alarming, press Reset on the laser module to stop the alarm, but you need to pay attention to the current working status of the laser module. For more information about this function, please refer to the "GRBL Configuration Parameters" in the TF card.

## FIRE: Detects whether the processed material is burning.

- Red: Flame is detected. It is recommended to stop the current work immediately to ensure safety.
- Orange: There is a fire hazard. Please confirm the material and set the working parameters properly.
- Green: No flame is detected. Please clean and maintain the laser module regularly.

## AIR: Detects the current airflow passing through the laser module.

- Flashing red: No airflow. Smoke and dust may contaminate the lens during engraving or cutting, please check the working status of the air pump and ensure that the silicone tube is connected.
- Solid orange: Small airflow volume. It is recommended to enable a small airflow volume when engraving, since a large airflow volume can affect the engraving result.
- Solid green: Large airflow volume. The airflow volume can be adjusted according to individual needs when cutting.



## LENS: Detects whether the lens of the laser module is dirty.

- Red: The lens is seriously dirty. Please stop the current work immediately, and clean and maintain the laser module.
- Orange: The lens is slightly dirty. It is recommended to stop the current work as soon as possible, and clean and maintain the laser module.
- Green: The lens is not dirty. Please clean and maintain the laser module regularly.



## 07 OPERATION



1. After placing different materials, you need to use a multi-level fixed focus block to adjust the height of the laser module.
2. For the basic parameter setting operation of the laser engraving device, please refer to the file in the TF card - " GRBL Configuration Parameters "
3. Firmware Upgrade --- "<https://www.creativitycloud.cn/en/software-firmware/other?type=16>" In order to use the latest version of firmware, you can download the live updated firmware version here. First, please back up the files in the original TF card to your computer, and then clear the TF card to prevent lags during use of the TF card. Then save the newly downloaded BIN file to the first-level directory of the TF card.

### A. Motherboard Firmware

When the power is off, insert the TF card into the card slot of the device, and the device will automatically update when it is powered on. The buzzer will keep sounding during the update process. When the sound stops, the update is completed.

⚠ Do not turn off the power during the update process.

### B. Laser Module Firmware

When the power is off, pass the TF card through the card reader, and then insert it into the Type-C interface on the top of the laser module through the A-to-C adapter. The device will automatically update when it is powered on. During the update process, the indicator lights of the laser module will light up orange in sequence, and stay green to indicate the update is complete.

⚠ Do not turn off the power during the update process.

### 4. Software Installation & Use





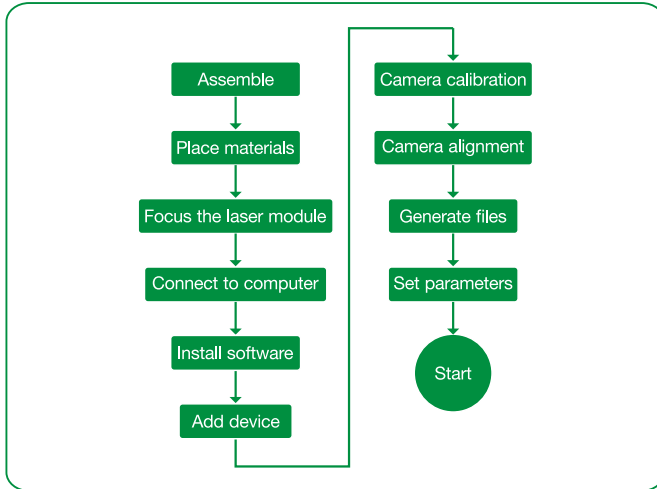

The device can work online through Type-C cable (LaserGRBL, LightBurn), or offline through TF card (LightBurn). For detailed software tutorials, please refer to the file in the TF card.

Note: TF card - product manual, assembly instructions, camera calibration and alignment, parameter recommendation, software operation tutorials, G-Code, description for error code, GRBL Configuration Parameters, FAQ, etc.

## Control from PC

Connect the device to a PC via a USB-C cable. While controlling from PC, you can also control it through  on the control panel of the device.



- 1) Press  and the device will enter the preview mode from the standby mode. The laser module will emit a weak beam and move along the X/Y axis to frame the target working area. The indicator will be in solid blue. You can adjust the material to a suitable position, or make fine adjustments through  on the control panel.
- 2) In the preview mode, press  to enter the engraving mode, the laser module will emit a strong beam, and start engraving. The indicator will be in solid blue. Press  to pause the device, and the indicator light will be green gradient Light. Press  again to continue engraving. Press and hold  for 3 seconds to call of the device operation. The device will beep once and reset. After reset, the device will beep twice and enter standby mode. The indicator will be green gradient Light.

## Work with TF Card

Generate engraving or cutting files (g-code) through LightBurn and save the files to the first-level directory of the TF card. Before powering on, insert the TF card into the card slot of the device, and then confirm that the triple switch is turned on. After the power is turned on, the device will beep twice. After initialization, the device will enter standby mode and the indicator light will turn green.

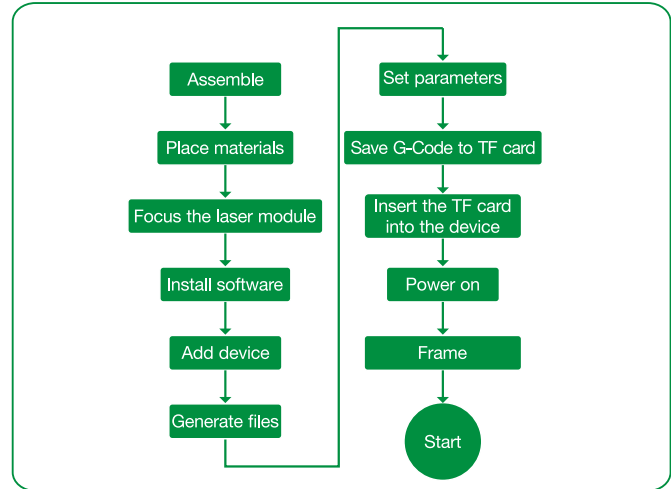

- 3) After the engraving is completed, the device will emit three long beep and then reset. After reset the device will beep once and enter standby mode, and the indicator will be green gradient Light.

Note: 1. If the computer does not have a USB-A port, there is a provided A to C adapter for conversion.

2. By default, the device reads the latest engraving files in the first-level directory of the TF card. It is recommended to delete other engraving files in the first-level directory.

## 08 FAQ

1. Why does the carved work fail to achieve the expected effect compared with the original image? (Like the engraving effect is relatively light and the lines are crooked)
  - A. There are recommended parameters for engraving and cutting on the official website or TF card.
  - B. At the same time, please check whether the device screws are tightened and whether the belt is appropriately tight to eliminate hardware problems.Note:
  - 1) When the laser module is under the action of gravity, it can slide slowly on the X-axis profile perpendicular to the desktop;
  - 2) When there is no idle slip on any pulley in the laser head assembly;
  - 3) The belt tightness is appropriate. Otherwise, please adjust the belt tightness manually.
2. Is it possible to engrave on reflective/transparent materials such as ceramics/glass?

Yes, but before engraving, you need to apply anti-reflective material on the surface of the material to ensure the engraving effect and prevent reflected light from damaging the laser module.
3. What should I do if the software does not respond or cannot connect when engraving online?
  - A. Make sure the data cable has communication function and the end of the data cable connected to the computer is a USB-A interface. If the computer does not have a USB-A interface, there is an A to C adapter to convert it, or use a hub with a USB-A port.
  - B. Make sure you have successfully imported the Creality Falcon2.lbdev file according to the LightBurn software tutorial in the TF card.
  - C. Make sure that the COM port corresponding to the engraving device is not occupied.
  - D. If it still can't be connect, please record a short video of the connection operation, and feed back the relevant system information and software version number to the after-sales team to troubleshoot the problem more quickly.



SHENZHEN CREALITY 3D TECHNOLOGY CO.,LTD.

Official Website: [www.creality.com](http://www.creality.com)

Business Tel: +86 755-8523 4565 E-mail: [falcon@creality.com](mailto:falcon@creality.com)

Company Address: 18th Floor, JinXiuHongDu Building, Meilong Road,  
Xinniu Community, Minzhi Street, Longhua District, Shenzhen City, China.



## 09 TROUBLESHOOTING

### ERROR:01

The angle data is abnormal and it has stopped working.  
Please check whether the workbench is shaking, the screws are locked tightly and the frame of the machine is firmly.

### ERROR:02

There is no G-Code file in the root directory of the TF card.  
Please check whether the suffix of the file in the TF card is ".gcode/.gc/.nc", and ensure the file is saved in the root directory.

### ERROR:04

No airflow is detected and the machine has stopped working.  
Please check whether the air pump is connected to the machine, check whether the knob switch on the left side of the machine is adjusted to the maximum, and check whether the silicone air tube above the laser module is inserted and there is no bending.  
You can set \$153 to 0 to cancel the alarm function (it is recommended to set it according to the actual situation).

### ERROR:05

The flame is detected and the machine has stopped working.  
Please press the Reset button if the material is not burning, and the FIRE light will turn orange, indicating that there is a risk of fire. You can press the start button to continue working and after restarting the machine, the FIRE light will be green. Refer to "Laser Module Alarm Functions. pdf" for more information. You can set \$154 to 0 to cancel the alarm function (it is recommended to set it according to the actual situation).

### ERROR:06

Lens contamination is detected and the machine has stopped working.  
Please press the Reset button and the LENS light will turn orange. You can press the start button to continue working and the lens needs to be cleaned when power off. The LENS will still keep red light flashing when power on. You need to press the reset button again to confirm that the lens is clean and the LENS light will be green. Refer to "Laser Module Alarm Functions. pdf" for more information.  
You can set \$155 to 0 to cancel the alarm function (it is recommended to set it according to the actual situation).

### ERROR:07

The temperature of the laser module is high and it has stopped working.  
You can press the Reset button and then press the Start button to continue the current work.  
It is recommended to clean the laser module when power off and wait for the laser module to cool down to a suitable temperature before working.  
You can set \$158 to 0 to cancel the alarm function (it is recommended to enable the alarm function).

### ERROR:08

The air pressure sensor of the laser module is abnormal.  
It is recommended to restart the machine to see if it is solved. If it still exists, please contact the after-sales service for relevant technical support.

### ERROR:09

The flame sensor of the laser module is abnormal.  
It is recommended to restart the machine to see if it is solved. If it still exists, please contact the after-sales service for relevant technical support.

### ERROR:10

The lens sensor of the laser module is abnormal.  
It is recommended to restart the machine to see if it is solved. If it still exists, please contact the after-sales service for relevant technical support.

### ERROR:11

The laser module does not have an LD temperature sensor.  
It is recommended to restart the machine to see if it is solved. If it still exists, please contact the after-sales service for relevant technical support.

### ERROR:12

Laser module LD sensor short circuit.  
It is recommended to restart the machine to see if it is solved. If it still exists, please contact the after-sales service for relevant technical support.

### ERROR:13

The CPU temperature of the laser module is too high.  
It is recommended to clean the laser module after power off and wait for the laser module to cool to the appropriate temperature before working.

### ERROR:14

The temperature of host CPU is too high.  
Please check whether the ambient temperature is too high. It is recommended to wait for the host to cool down to a suitable temperature before working.

### ERROR:24

The machine is in an unsealed state.  
Please close the protective cover and drawer, and then press the start button of the device to continue working.

### ERROR:25

The air pump is abnormal.  
Please contact the after-sales service for relevant technical support.