



RG-E4 Router

Quick Installation Guide

 For any inquiries, suggestions, or product-related assistance, please email us at techsupport@ireyee.com.

 For comprehensive technical support, user manuals, and other helpful information, please visit <https://www.ireyee.com>.

2 Set Up Your Router

Method 1: Via a Web Browser

1. Connect your smartphone or computer to the router using a wired or wireless connection.

For the wired connection, use an Ethernet cable to connect your computer's Ethernet port to any LAN port on the router.

For the wireless connection, open Wi-Fi settings on your smartphone, and connect to the Wi-Fi network that starts with @Reyee. You can find the specific Wi-Fi name on the label at the bottom of the router indicated by SSID.

2. Follow the instructions on the displayed setup page to complete the setup. If the setup page is not displayed, open a web browser, enter **192.168.110.1** in the address bar.

If you are still unable to access the setup page, see Q1 in FAQ for further assistance.

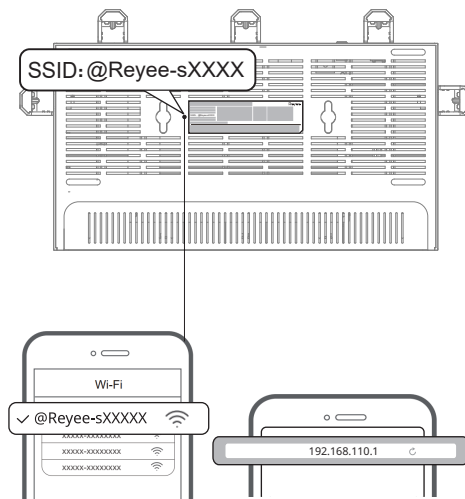

Method 2: Via an App

Download up-to-date Reyee Router App. Follow app instructions to complete setup.



or



Reyee Router app

1 Connect Your Router

- If you use a modem for Internet access, power off your modem and remove the backup battery if it has one.
- If you do not have a modem, you can connect the Ethernet port in the wall directly to the WAN port of your router. Once connected, proceed to follow steps 3 and 4.

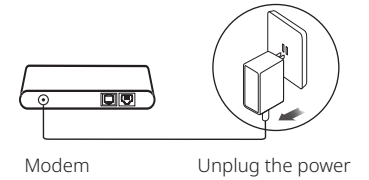

- 1 Connect the modem to the WAN port on the router using an Ethernet cable.
- 4 Verify the LED on the top of the router until it turns solid red or green.

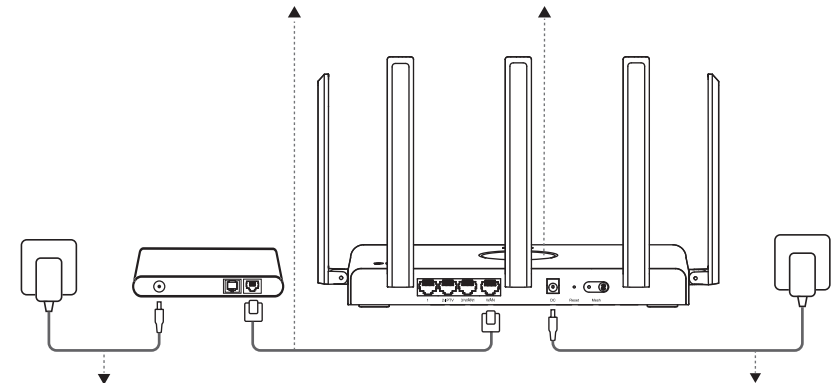

- 2 Power on the modem and wait for it to restart.
- 3 Connect the power adapter to the router.

3 Add a Reyee Unit

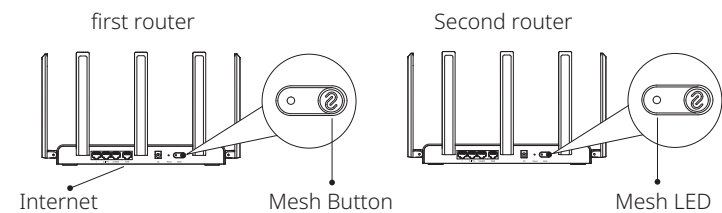

1. Set up the first reyee router using Method 1 or Method 2.

2. If possible, connect the WAN port of the second router to a LAN port of the first router using an Ethernet cable. (Follow Steps 3)





If not, place the second router within 2 meters (78.74 in.) of the first router. (Follow Steps 3 and 4)

3. Connect the second router to a power source. After the second router has initialized successfully, press the Mesh button on the first router. After the Mesh LED on the second router turns from blinking to solid on, the mesh connection between the two routers is established successfully.

4. Power off the second router, relocate it to the desired location and power it on. Make sure that there are no more than two walls between two routers.

- After the mesh network setup is successful, the Wi-Fi name and password of the second router will be the same as those of the first router.
- Before creating a mesh network, make sure that the second router has not been configured before. If you are uncertain, restore the second router to factory defaults by pressing the Reset button for more than 10 seconds.

For more details, please visit <https://www.ireyee.com>.

LED	Description	
 System LED	Solid Green	The router is connected to the Internet.
	Blinking	The router is starting up.
	Solid Orange	The mesh connection is weak.
	Solid Red	The router is not connected to the internet.
 Mesh LED	On	The mesh pairing is successful.
	Off	The mesh network is not connected.
	Blinking	The mesh pairing is in process.
Button	Description	
 Reset	With the router powered on, use a paper clip or similar tool to press and hold the Reset button at the back of the router for more than 10 seconds until the LED at the top starts blinking. The router will restore to factory defaults and restart.	
 Mesh Button	Pressing the Mesh button will allow the router to build a mesh network with nearby unconfigured Reyee routers and range extenders.	
 Label	The label at the bottom of the router contains information such as the product model, power parameters, default IP address, and default SSID.	

FAQ

Q1. What should I do if I fail to log in to the web interface?

- Restart the router.
- Configure your computer to obtain an IP address automatically.
- Make sure that the URL in the address bar of your browser is entered correctly. The default URL is <http://192.168.110.1>.
- Use another browser to try again. We recommend using Google Chrome.
- Unplug the Ethernet cable connecting your computer and the router. Then, plug it back in to establish a fresh connection.
- Restore the router to factory defaults.

Q2. What should I do if I cannot access the Internet?

- Power off the modem and wait for 5 minutes. Then, power on the modem, and check the network connection. If your modem has multiple Ethernet ports, keep other ports disconnected or unused during this process.
- Check whether your computer can access the Internet by directly connecting it to the modem. If not, please contact your Internet service provider.
- Log in to the web interface of your router, and check whether the WAN port has obtained an IP address. If so, choose **More > WAN** and configure commonly used local DNS addresses such as 8.8.8.8. If the WAN port has not obtained an IP address, see **"1. Connect Your Router"** or contact your Internet service provider.
- If you use a modem for Internet service, log in to the web interface of your router, choose **More > WAN**, and set the MAC address of the WAN port to be the MAC address of the old router. You can usually find the MAC address on the label at the bottom of the router.

Q3. What should I do if I forget the management password of the router?

- If you haven't bound the router to Reyee Router App and you are still unable to log in using the Wi-Fi password, try restoring the router to factory defaults.
- If you have previously bound the router to Reyee Router App, you can open Reyee Router App, and change the management password by choosing **Settings > Advanced > Management Password**.

Q4. Where should I place the router for better wireless coverage?

- Do not place the router in a corner or inside a network enclosure.
- Keep the router away from obstacles and high-powered appliances that may obstruct signals.
- Place the router on a desktop, and keep the antennas vertically upwards.

Safety Information

- Do not use your device if using the device is prohibited. Do not use the device if doing so causes danger or interference with other electronic devices.
- Do not attempt to disassemble, repair, or modify the device. If you need service, please contact us.
- Avoid dusty, damp, or dirty environments. Avoid magnetic fields. Using the device in these environments may result in circuit malfunctions.
- Please carefully check the ideal operating temperature and storage temperature on the user guide. Extreme heat or cold may damage your device or accessories.
- The device should be installed and operated with a minimum distance of 20 cm between the radiator and your body.
- Using an unapproved or incompatible power adapter, charger, power cord, cable or battery may damage your device, shorten its lifespan, or cause a fire, explosion, or other hazards.
- For pluggable devices, the socket-outlet shall be installed near the devices and shall be easily accessible.
- Adapter shall be installed near the equipment and shall be easily accessible.
- Do not touch the device or the charger with wet hands. Doing so may lead to short circuits, malfunctions, or electric shocks.
- If the product or external adapter includes one three-pole AC inlet, then plug the product into the wall outlets with earthing connection through the power supply cord which provided by the manufacturer.
- Do not block any ventilation openings. Install this apparatus in accordance with the manufacturer's instructions.
- Do not install this apparatus near any heat sources such as radiators, heat registers, stoves or other apparatus (including amplifiers) that produce heat.
- Protect the power cord from being walked on or pinched, particularly at plugs, convenience receptacles and the point where they exit from the apparatus.
- Users should only use power adaptors, attachments, accessories supplied or specified by the manufacturer.
- Use only with the cart, stand, tripod, bracket or table specified by the manufacturer or sold with the apparatus. When a cart is used, use caution when moving the cart/apparatus combination to avoid injury from tip-over.

FCC Compliance Statements

This device complies with Part 15 of the FCC Rules. Operation is subject to the following two conditions: (1) this device may not cause harmful interference, and (2) this device must accept any interference received, including interference that may cause undesired operation.

Note: This equipment has been tested and found to comply with the limits for a Class B digital device, pursuant to Part 15 of the FCC Rules. These limits are designed to provide reasonable protection against harmful interference in a residential installation. This equipment generates, uses and can radiate radio frequency energy and, if not installed and used in accordance with the instructions, may cause harmful interference to radio communications. However, there is no guarantee that interference will not occur in a particular installation.

If this equipment does cause harmful interference to radio or television reception, which can be determined by turning the equipment off and on, the user is encouraged to try to correct the interference by one or more of the following measures:

- Reorient or relocate the receiving antenna.
- Increase the separation between the equipment and receiver.
- Connect the equipment into an outlet on a circuit different from that to which the receiver is connected.
- Consult the dealer or an experienced radio/TV technician for help.

Caution: Changes or modifications not expressly approved by the party responsible for compliance could void the user's authority to operate the equipment.

FCC Radiation Exposure statement

This equipment complies with FCC radiation exposure limits set forth for an uncontrolled environment. This equipment should be installed and operated with minimum distance 20cm between the radiator and your body.

ISED Compliance Statements

This device contains licence-exempt transmitter(s)/receiver(s) that comply with Innovation, Science and Economic Development Canada's licence-exempt RSS(s). Operation is subject to the following two conditions: (1) This device may not cause interference, (2) This device must accept any interference, including interference that may cause undesired operation of the device.

L'émetteur/récepteur exempt de licence contenu dans le présent appareil est conforme aux CNR d'Innovation, Sciences et Développement économique Canada applicables aux appareils radio exempts de licence. L'exploitation est autorisée aux deux conditions suivantes : (1) L'appareil ne doit pas produire de brouillage; (2) L'appareil doit accepter tout brouillage radioélectrique subi, même si le brouillage est susceptible d'en compromettre le fonctionnement.

ISED Radiation Exposure statement

This equipment complies with IC RSS-102 radiation exposure limits set forth for an uncontrolled environment. This equipment should be installed and operated with minimum distance 20 cm between the radiator and your body.

Cet équipement est conforme aux limites d'exposition aux radiations IC CNR-102 établies pour un environnement non contrôlé. Cet équipement doit être installé et utilisé avec une distance minimale de 20 cm entre le radiateur et votre corps.

5G Statement

The user manual for LE-LAN devices shall contain instructions related to the restrictions mentioned in the above sections, namely that:

- a) the device for operation in the band 5150-5250 MHz is only for indoor use to reduce the potential for harmful interference to co-channel mobile satellite systems;
- a) les dispositifs fonctionnant dans la bande 5150-5250 MHz sont réservés uniquement pour une utilisation à l'intérieur afin de réduire les risques de brouillage préjudiciable aux systèmes de satellites mobiles utilisant les mêmes canaux;

Packaging Contents

Check the router and all accessories after removing the packaging materials.

1x Router 1x Power Adapter 1 x User Manual 1 x Warranty Card 1 x Network cable 1 x Sympathy Card