

Product Name: LED360 Degree tube

Product Model: CL-T100W

Overview: 360 degree tube light use low-voltage DC power supply, double-sided SMD led beads and 360-degree light emission without dark areas. The tube can achieve monochrome and full-color effect changes, there is a variety of specifications ,sizes and installation methods, suitable for stage lighting, bar decoration, events Conference decorations, concerts and other stage events.

1m 360 degree tube diagram:

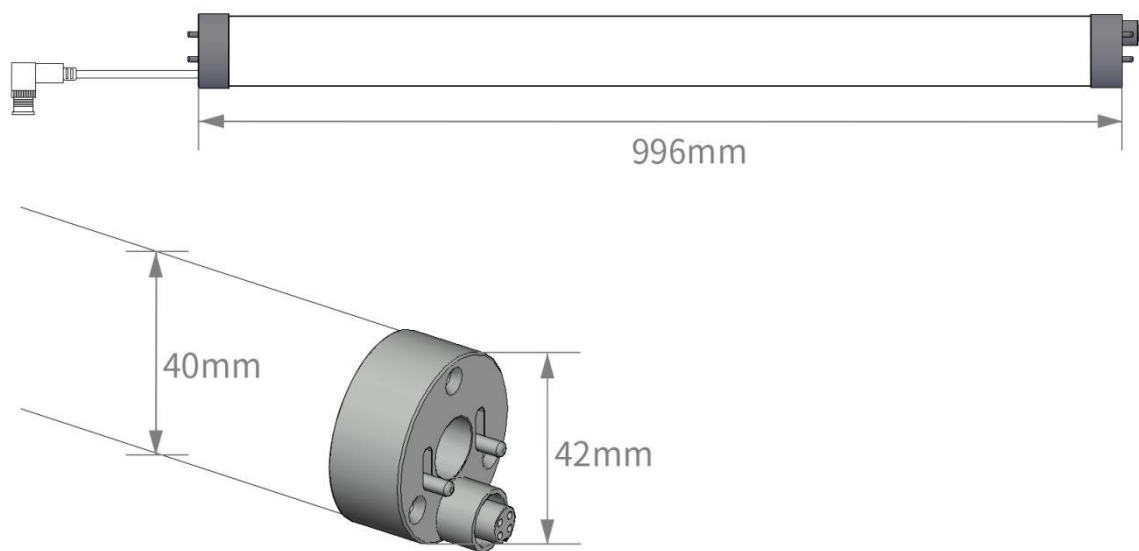

Features

- Single signal transmission, SPI control mode;
- 256 levels of gray change, PC material, beautiful effect, strong resistance to pressure
- 360°light emitting without dark area
- The parts at both ends of the tube can be detached and installed



The parts at both ends of the tube can be detached and installed

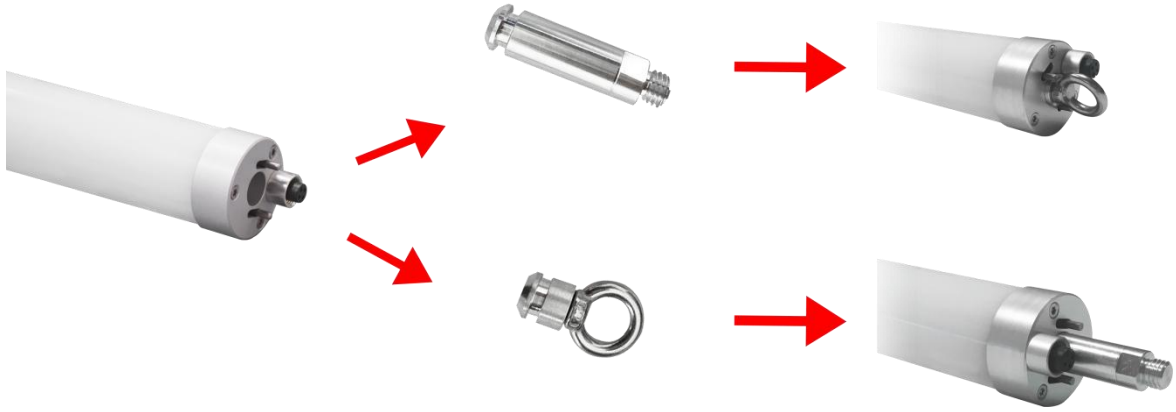

➤ Signal foldback function;

The tube's beginning and end can be connected in series, the pin end is input, the hole end is output

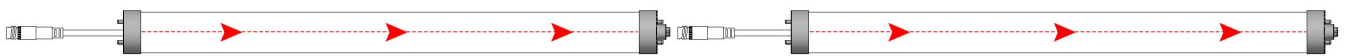

Signal foldback, can use T cable wire to connect the input side in series

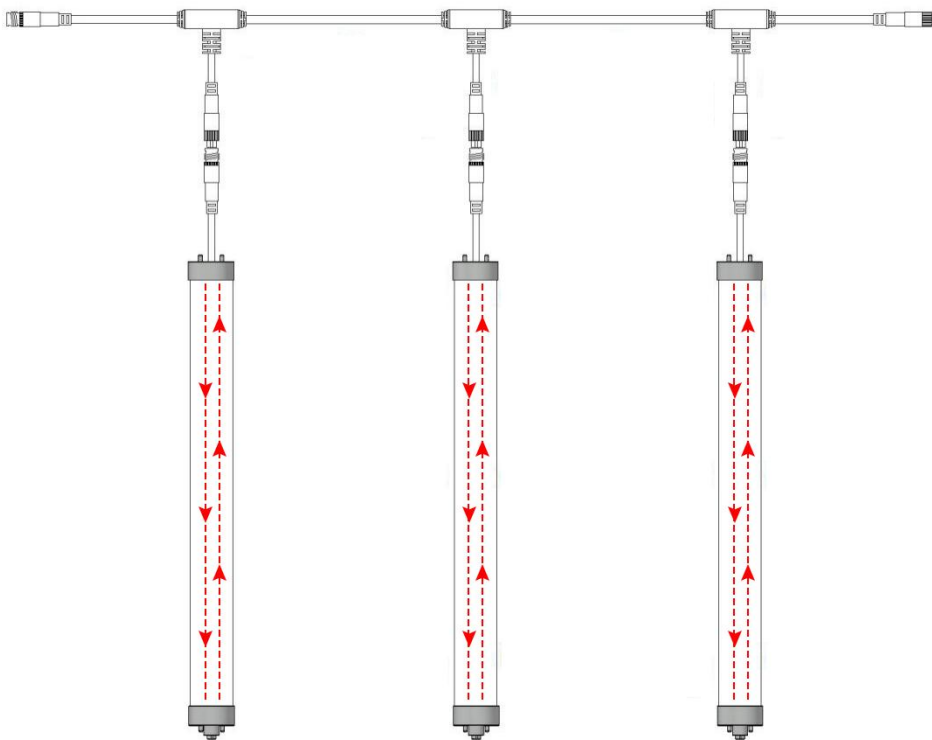

◆ Three installation methods:

(1)with 26holes ball



Each side of the tube use screw to connect with 26hole ball. And can build, Can build a variety of different shapes

(2) With Eye hook for hang installation

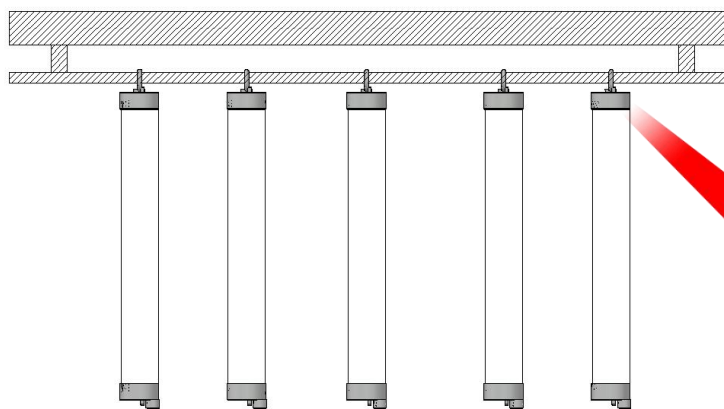

Each side of the tube can use eye-hook and can work with T cable wire for hang installation



(3) With Floor stand



Use with floor stand, widely use for some park, show and stage

*Normal size Specification

Length (mm)	500	1000	1200	1500	2000
Pixel (pcs)	12	24	30	36	48

◆ Parameter list

Item	Unit	Min.	Typical	Max.
Working voltage (U)	V	—	24	—

Max Power (P)	W	—	24	—
Quiescent Current (I)	A	—	—	—
ESD voltage (Vesd)	V	2000	—	—
R-wavelength (λD)	nm	620	—	625
G-wavelength (λD)	nm	515	—	520
B-wavelength (λD)	nm	460	—	470
Luminous flux (lv)	LM	—	—	—
Beam angle	Deg	—	360	—
Working temperature (Topt)	°C	-20	—	60
Storage temperature (Tstg)	°C	-20	—	60
IP Grade (IP)	—	—	65	—
Weight (N.W)	KG	—	0.53	—
LED specifications	—	—	5050RGB	—
LED Qty(PCS)	PCS	—	144	—
IC Model	—	—	UCS1903	—
Gray level (Gray)	—	—	256	—
Channel	—	—	RGB	—
Pixel	PCS	—	24	—
Cover Material	—	—	Milky PC tube	—

◆ **Connection and control**

① connect 360 degree tube with controller

The XLR cable connects with the output port of the controller and the input cable of the led bar (male connector is input, and female connector is output).

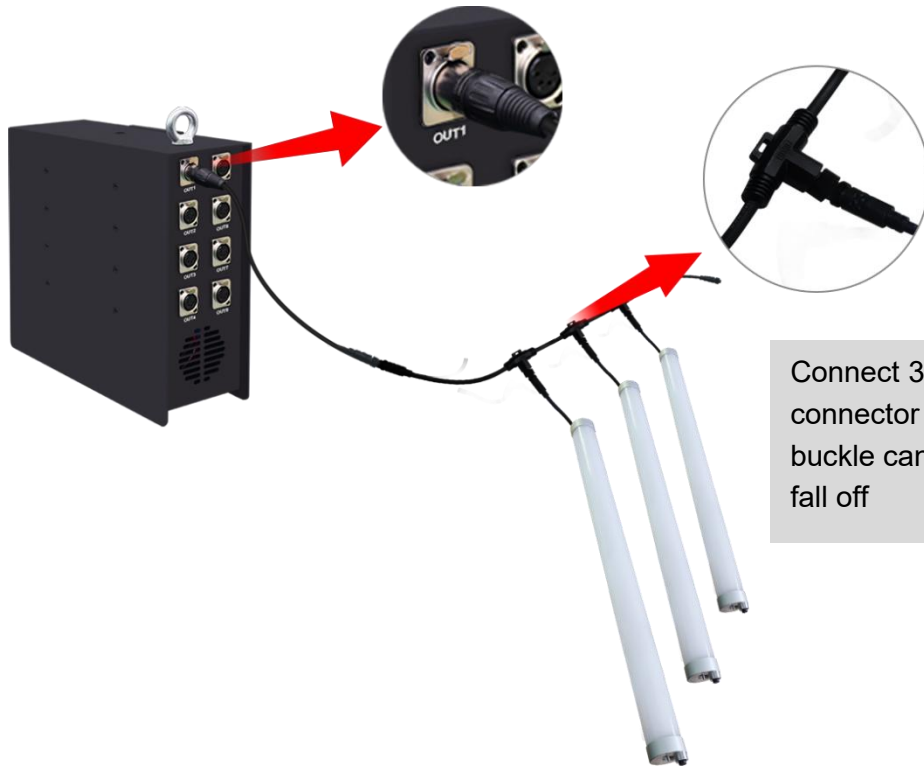

Connect 360 degree tube's 4pin input side connector with T cable wire and rotating buckle can be locked to prevent accidental fall off

② Connect the controller with software

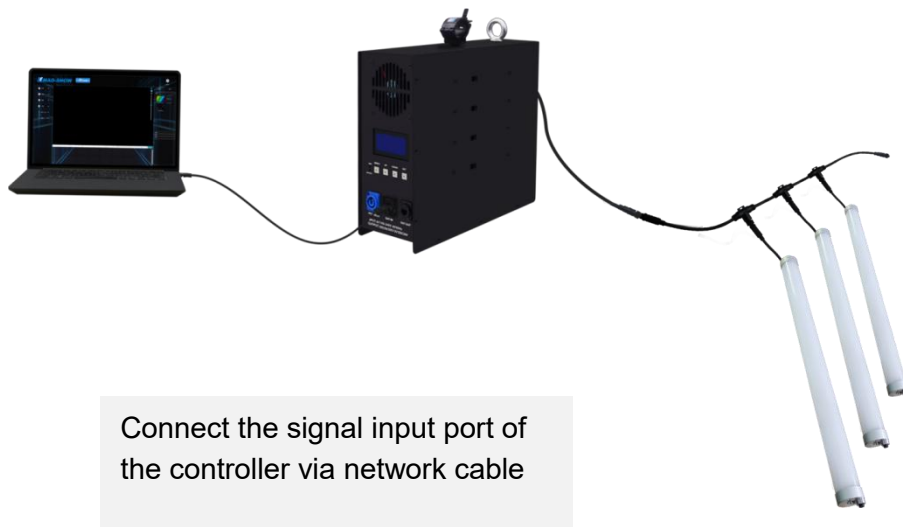

Connect the signal input port of the controller via network cable

Connect the controller with console

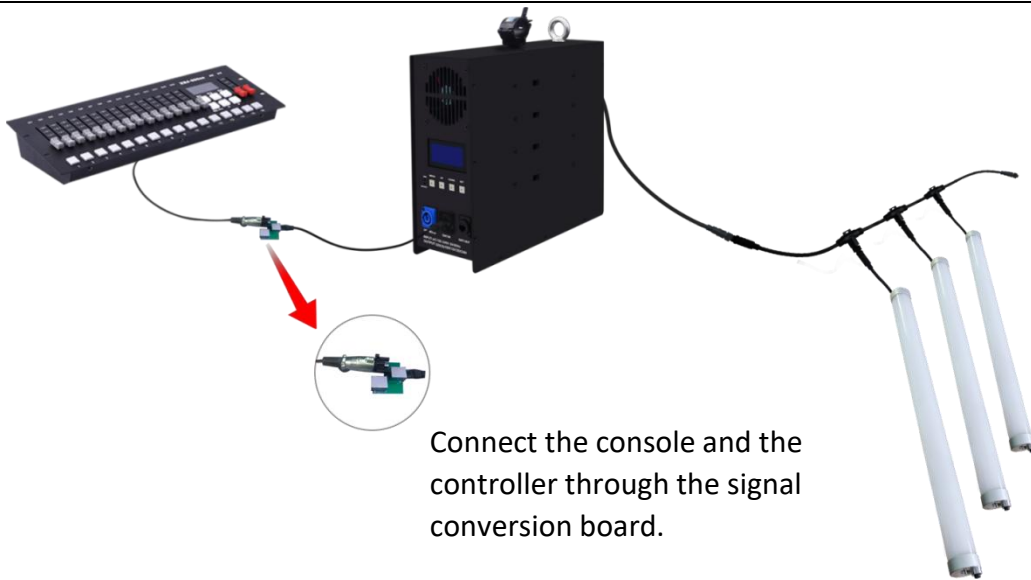

③ Turn on the power, set the software and controller parameters to achieve control

◆ Application

1. Stage lighting and atmosphere construction;
2. Club atmosphere lighting;
3. Linear contour light for music festivals, concerts and advertising screens;
4. Park night view decoration;
5. Lighting decoration for product launch.



Attention

1. This product is D40PC round tube appearance, avoid contact with corrosive environment and objects.

-
- 2 . Pay attention to the wiring sequence when installing the product . Do not connect it incorrectly to avoid damaging the lamp.
 - 3 . The power supply should be selected to match the voltage of the lamp belt to avoid undesirable phenomena.
 - 4 . Pay attention to the input and output of the lamp and the direction of the lamp during product installation.
 - 5 . During the installation of the controller , the number of loaded pixels must not exceed the range of the controllers loading capacity Around , otherwise there will be no light or flickering.
 - 6 . The number of pixels in a single cascade should not exceed 90% of the ports load capacity to achieve the best results.
 - 7 . The power load power should be controlled as much as 80% of the total power of the power supply.
 - 8 . This product is not waterproof , pay attention to the use environment.