

LED Zoom Moving Head 4X60W + 64x1.5W RGB



CE   IP20 LED  9.2mm  t_a 40°C t_s 150°C

User Manual

1 SAFETY INSTRUCTIONS



CAUTION

Becareful with your operations. With a dangerous voltage you cansuffer a dangerous electric shock when touching wires!

This device has left the factory in perfect condition. In order to maintain this condition and to ensure a safe operation, it is absolutely necessary for the user to follow the safety instructions and warning notes written in this user manual.



IMPORTANT

Damages caused by the disregard of this user manual are not subject to warranty. The dealer will not accept liability for any resulting defects or problems.

If the device has been exposed to temperature changes due to environmental changes, do not switch it on immediately. The arising condensation could damage the device.

Leave the device switched off until it has reached room temperature.

This device falls under protection-class I. Therefore it is essential that the device be earthed.

The electric connection must carry out by qualified person.

The device shall only be used with rate voltage and frequency.

Make sure that the available voltage is not higher than stated at the end of this manual.

Make sure the power cord is never crimped or damaged by sharp edges. If this would be the case, replacement of the cable must be done by an authorized dealer.

Always disconnect from the mains, when the device is not in use or before cleaning it.

Only handle the power cord by the plug. Never pull out the plug by tugging the power cord.

During initial start-up some smoke or smell or smell may arise. This is a normal process and does not necessary mean that the device is defective, it should decrease gradually.

Please don't project the beam onto combustible substances.

Fixtures cannot be installed on combustible substances, keep more than 50cm distance with wall for smooth air flow, so there should be no shelter for fans and ventilation for heat radiation.

If the external flexible cable or cord of this luminaire is damaged, it shall be exclusively replaced by the manufacturer of his service agent or a similar qualified person in order to avoid a hazard.

2 ***UNPACKING***

Thank you for choosing our LED Zoom Moving Head moving head light. For your own safety, please read this manual before installing the device. This manual covers the important information on installation and applications. Please install and operate the fixture with following instructions. Meanwhile, please keep this manual well for future needs.

The LED Zoom Moving Head is made of a new type of high temperature strength of engineering plastic and cast aluminum casing with nice outlook. The fixture is designed and manufactured strictly following CE standards, complying with international standard DMX512 protocol. It's available independently controlled and linkable with each other for operation. And it is applicable for large-scale live performances, theater, studio, nightclubs and discos.

The Zoom Moving Head Moving head light which features high brightness and stability. Please carefully unpack it when you receive the fixture and check whether it is damaged during the transportation. And please check whether the following items are included inside the box:

3 ***FEATURES & SPECIFICATIONS***

Features

- Light source: 4pcs 60W LED + 64X1.5W RGB
- 50,000 hours lifespan and low power consumption
- Zoom angle 6° ~42°
- High light output,26000LUX@5M at White light Zoom in, 900LUX@5M at White light zoom out
- Temperature protect function, when the internal Temperature is up to 40° then the fans begin to work, when the internal temperature is up to 70°and the brightness

reduce half.

- High speed strobe effect with 1-25 flashers per second
- Internal program available
- 30/28/14/12 DMX Channels USITT DMX-512
- DMX 512, master-slave and sound activated controllable or auto operation
- Colorful LCD display
- Efficient low noise fan cooling system
- PowerCon IN/OUT
- 3-pin & 5-pin XLR connectors IN/OUT
- Two 1/4 turn fastening Omega Clamps
- IP 20 protection rating

Specifications

Input Voltage: AC90-260V 50/60Hz

Light Source: 4pcs 60W LED + 64X1.5W RGB

Control Signal: DMX 512, master-slave and sound activated or auto operation

Control Channel: 30/28/14/12 DMX Channels USITT DMX-512

Power Consumption: 350W

Dimensions: 300(L)*220(W)*480(H)mm

Packing size:

Net Weight: 13.50kg,Gross Weight: 16.50kg

4

OPERATION INSTRUCTIONS

- The moving head is for spot effect for on-site decoration purpose.
- Don't turn on the fixture if it's been through severe temperature difference like after transportation because it might damage the light due to the environment changes. So make sure to operate the fixture until it is in normal temperature.
- This light should be keep away from strong shaking during any transportation or movement.
- Don't pull up the light by only the head, or it might cause damages to the mechanical parts.

- Don't expose the fixture in overheating, moisture or environment with too much dust when installing it. And don't lay any power cables on the floor. Or it might cause electronics shock to the people.
- Make sure the installation place is in good safety condition before installing the fixture.
- Make sure to put the safety chain and check whether the screws are screwed properly when installing the fixture.
- Make sure the lens are in good condition. It's recommended to replace the units if there are any damages or severe scratch.
- Make sure the fixture is operated by qualified personnel who know the fixture before using.
- Keep the original packages if any second shipments is needed.
- Don't try to change the fixtures without any instruction by the manufacturer or the appointed repairing agencies.
- It is not in warranty range if there are any malfunctions from not following the user manual to operate or any illegal operation, like shock short circuit, electronic shock, lamp broke, etc.

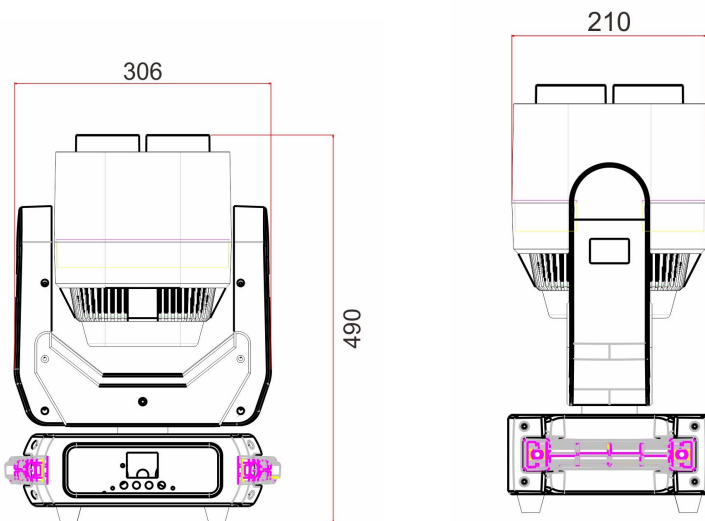

5 INSTALLATIONS

Cautions: For added protection mount the fixtures in areas outside walking paths, seating areas, or in areas where the fixture might be reached by unauthorized personnel.

Before mounting the fixture to any surface, make sure that the installation area can hold a minimum point load of 10 times the device's weight.

Fixture installation must always be secured with a secondary safety attachment, such as an appropriate safety cable.

Never stand directly below the device when mounting, removing, or servicing the fixture.

From a ceiling, or set on a flat level surface (see illustration below). Be sure this fixture is kept at least 0.5m (1.5ft) away from any flammable materials (decoration etc.).

Always use and install the supplied safety cable as a safety measure to prevent accidental damage and/or injury in the event the clamp fails.

Mounting points: Overhead mounting requires extensive experience, including amongst others calculating working load limits, a fine knowledge of the installation material being used, and periodic safety inspection of all installation material and the fixture. If you lack these qualifications, do not attempt the installation yourself. Improper installation can result in bodily injury.

Be sure to complete all rigging and installation procedures before connecting the main power cord to the appropriate wall outlet.

Clamp Mounting: The LED moving head provides a unique mounting bracket assembly that integrates the bottom of the base, and the safety cable rigging point in one unit (see the illustration below). When mounting this fixture to truss be sure to secure an appropriately rated clamp to the included omega bracket using a M10 screw fitted through the center hole of the "omega bracket". As an added safety measure be

sure to attached at least one properly rated safety cable to the fixture using on of the safety cable rigging point integrated in the base assembly.



- ① Omega Bracket
- ② Safety Clamp
- ③ Safety Cable
- ④ 1/4 Turn Quick-Lock Fasteners

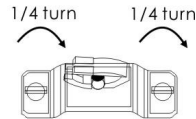
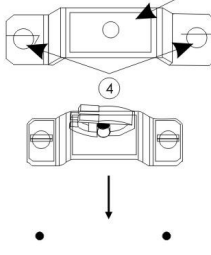
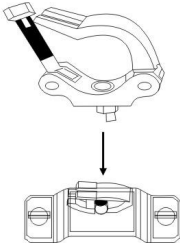
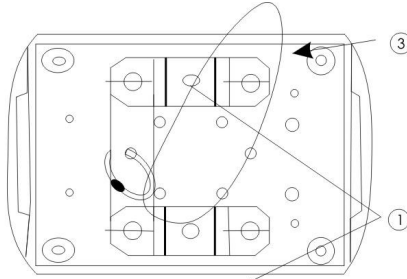

Regardless of the rigging option you choose for your LED moving head, always be sure to secure your fixture with a safety cable. The fixture provides a built-in rigging point for a safety cable on the hanging bracket as illustrated above. Be sure to only use the designated rigging point for the safety cable and never secure a safety cable to a carrying handle.

6 DMX-512 CONTROL CONNECTIONS

Connect the provided XLR cable to the female 3-pin XLR & 5-pin XLR output of your controller and the other side to the male 3-pin XLR & 5-pin XLR input of the moving head. You can chain multiple moving head together through serial linking. The cable needed should be two core, screened cable with XLR input and output connectors. Please refer to the diagram below.

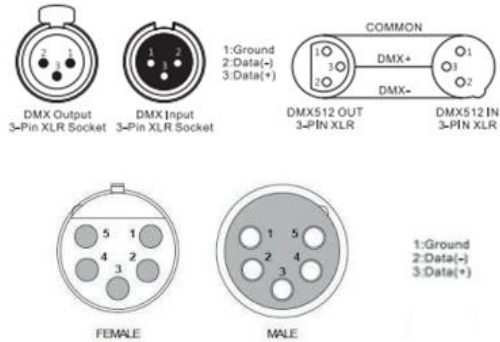

For installations where the DMX cable has to run a long distance or is in an electrically noisy environment, such as in a discotheque, it is recommended to use a DMX terminator. This helps in preventing corruption of the digital control signal by electrical noise. The DMX terminator is simply an XLR plug with a $120\ \Omega$ resistor connected between pins 2 and 3, which is then plugged into the output XLR socket of the last fixture in the chain. Please see illustrations below.

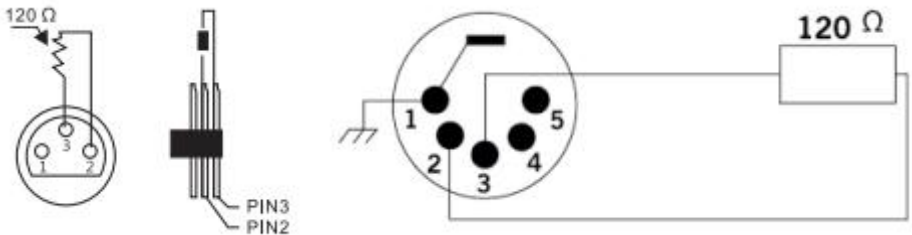

7 MENU OPERATIONS

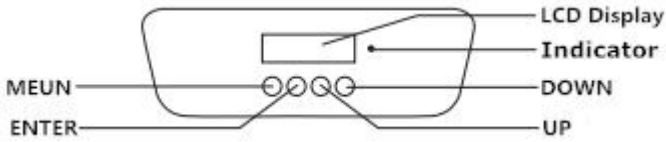

MENU

Address Set → *[Set Address Numbers]*

Run Mode

- *[DMX]*
- *[AUTO]* → *Auto 1- Auto 2*
- *[SOUND]*
- *[MANUAL]* → *Manual Test* → *Function and Operation*

Setup → *[Advanced Setting]*

- *Pan reverse*
- *Tilt reverse*
- *Display*
- *Screen Reverse*
- *Sensitivity (01-100)*
- *Motor zero*
- *Reset*
- *Factory Set*

System Information

- *Ver V1*
- *DMX Address*
- *Temperature*
- *Life time*

9

DMX CHANNELS

30/28/14/12 channel mode sheet

30CH	28CH	14CH	12CH	Function	Channel Value	Description
CH1	CH1	CH1	CH1	Pan	0-255	0-540°
CH2				Pan fine	0-255	Pan Fine
CH3	CH2	CH2	CH2	Tilt	0-255	0-270°
CH4				Tilt Fine	0-255	Tilt Fine
CH5	CH3	CH3	CH3	X, Y speed	0-255	From fast to slow
CH6	CH4	CH4	CH4	Zoom	0-255	From wide to narrow
CH7	CH5	CH5	CH5	LED Dimmer	0-255	From dark to bright
CH8	CH6	CH6	CH6	LED Strobe	0-24	open
					25-64	From fast to slow
					65-69	open
					70-84	Effect 1
					85-89	open
					90-104	Effect 2
					105-109	open
					110-124	Effect 3
					125-129	open
					130-144	Effect 4
					145-149	open
					150-164	Effect 5
165-169	open					

					170-184	Effect 6
					185-189	open
					190-204	Effect 7
					205-209	open
					210-224	Effect 8
					225-229	open
					230-244	Effect 9
					245-255	open
CH9	CH7	CH7	CH7	LED 1	0-255	Red from dark to bright
CH10	CH8	CH8	CH8	LED 1	0-255	Green from dark to bright
CH11	CH9	CH9	CH9	LED 1	0-255	Blue from dark to bright
CH12	CH10	CH10	CH10	LED 1	0-255	White from dark to bright
CH13	CH11			LED 2	0-255	Red from dark to bright
CH14	CH12			LED 2	0-255	Green from dark to bright
CH15	CH13			LED 2	0-255	Blue from dark to bright
CH16	CH14			LED 2	0-255	White from dark to bright
CH17	CH15			LED 3	0-255	Red from dark to bright
CH18	CH16			LED 3	0-255	Green from dark to bright
CH19	CH17			LED 3	0-255	Blue from dark to bright
CH20	CH18			LED 3	0-255	White from dark to bright
CH21	CH19			LED 4	0-255	Red from dark to bright
CH22	CH20			LED 4	0-255	Green from dark to bright
CH23	CH21			LED 4	0-255	Blue from dark to bright
CH24	CH22			LED 4	0-255	White from dark to bright
CH25	CH23	CH11	CH11	LED color mix	0-10	No function
					11-20	Color 1
					21-30	Color 2
					31-40	Color 3

				41-50	Color 4
				51-60	Color 5
				61-70	Color 6
				71-80	Color 7
				81-90	Color 8
				91-100	Color 9
				101-110	Color 10
				111-120	Color 11
				121-130	Color 12
				131-140	Color 13
				141-150	Color 14
				151-160	Color 15
				161-170	Color 16
				171-180	Full color
				181-235	Gradual change from slow to fast
				236-240	Full color
				241-255	Jump change from slow to fast
CH26	CH24		LED Pixel-mapping control (built-in program)	0-25	No function
				26-41	Program 1
				42-57	Program 2
				58-73	Program 3
				74-89	Program 4
				90-105	Program 5
				106-121	Program 6
				122-137	Program 7
				138-153	Program 8
				154-169	Program 9
				170-185	Program 10

					186-201	Program 11
					202-217	Program 12
					218-233	Program 13
					234-249	Program 14
					250-255	Program 15
CH27	CH25			LED pixel-mapping control speed adjust	0-127	LED CW speed from fast to slow
					128-255	LED CCW speed from slow to fast
CH28	CH26	CH12		LED round	0-25	No function
					26-30	Red
					31-35	Green
					36-40	Blue
					41-45	Full color
					46-50	Colorful jump change
					51-55	strobe
					56-60	Built-in 1
					61-65	Built-in 2
					66-70	Built-in 3
					71-75	Built-in 4
					76-80	Built-in 5
					81-85	Built-in 6
					86-90	Built-in 7
					91-95	Built-in 8
96-100	Built-in 9					
101-105	Built-in 10					
106-110	Built-in 11					
111-115	Built-in 12					

					116-255	Built-in 13
CH29	CH27	CH13		LED round built-in program speed	0-255	Speed from fast to slow
CH30	CH28	CH14	CH12	self-setting Program	0-7	No action
					8-131	Auto mode
					132-249	Sound mode
					250-253	Reset
					254-255	No action

10 ***MAINTENANCE AND CLEANING***

The following points have to be considered during the inspection:

- 1) All screws for installing the devices or parts of the device have to be tightly connected and
must not be corroded.
- 2) There must not be any deformations on the housing, color lenses, fixations and installation
spots (ceiling, suspension, trussing).
- 3) Mechanically moved parts must not show any traces of wearing and must not rotate
with
unbalances.
- 4) The electric power supply cables must not show any damage, material fatigue or sediments.

Further instructions depending on the installation spot and usage have to be adhered by a skilled installer and any safety problems have to be removed.



CAUTION

Disconnect from mains before starting maintenance operation.



In order to make the lights in good condition and extend the life time, we suggest a regular cleaning to the lights.

- 1) Clean the inside and outside lens each week to avoid the weakness of the lights due to accumulation of dust.
- 2) Clean the fan each week.
- 3) A detailed electric check by approved electrical engineer each three month, make sure that the circuit contacts are in good condition, prevent the poor contact of circuit from overheating.

We recommend a frequent cleaning of the device. Please use a moist, lint-free cloth. Never use alcohol solvents.

There are no serviceable parts inside the device. Please refer to the instructions under “Installation instructions”.

Should you need any spare parts, please order genuine parts from your local dealer.