

295W BEAM LIGHT

USER MANUAL

(TFT DISPLAY)



Please read over this manual before operation the light

CONTENTS

Chapter 1 Installation and attention	1
1. Maintenance	1
2. Statement	1
3. Safety Precaution	1
4. Cable connection (DMX)	1
5. Rigging (Optional)	2
6. RDM NOTE	3
Chapter 2 Panel operation	4
1. Brief	4
2. Operation	5
1. Operate fixture with knob or button	5
2. Parameter value setting	5
3. Boolean parameter setting	6
4. Sub Menu (Parameter)	6
5. Anti wrong touch operation of key	6
3. Operation and parameter instruction	8
1. DMX Address setting	8
2. Fixture operating mode setting	9
3. Set display	10
4. Scene	10
5. Set light run parameter	12
6. Status and information	13
Chapter 3 Channel description	15
1. Channel table	15

Chapter 1 Installation and attention

1. Maintenance

- To reduce the risk of electrical shock or fire, do not expose this unit to rain or moisture.
- Intermittently using will extend this item's service life.
- Please clear the fan, fan net, and optical lens in order to keep good work state.
- Do not use the alcohol or any other organic solvent to wipe the shell.

2. Statement

The product has perfect performance and integrity packing. All users should be strictly complying with the warning and operating instructions as stated. Any result by misusing is not within the Company's warranty. Any fault or problem caused by neglecting the manual is also not in the charge of dealers.

Note: All information is subject to change without prior notice.

3. Safety Precaution

- In order to guarantee the product's life, please don't put it in the damp places or even the environment over 60degrees.
- Always install this unit in safe and stable matter.
- Install or dismantle should operate by professional engineer.
- Using lamp, the change rate of power voltage should be within $\pm 10\%$, If the voltage is too high, it will shorten the light's life; If it's not enough, will influence the effect.
- Please restart it 20 minutes later after turning off light, until full-cooling. Frequent switching will reduce the life span of lamps and bulbs; intermittent using will improve the life of bulbs and lamps.
- In order to make sure the product is used well, please read the Manual carefully.

4. Cable connection (DMX)

Use a cable conforming to specifications EIA RS-485: 2-pole twisted, shielded, 120Ohm characteristic impedance, 22-24AWG, low capacity. Do not use microphone cable or other cable with characteristics differing from those specified. The end connections must be made using XLR type 3 or 5-pin male/female connectors. A terminating plug must be inserted into the last projector with a resistance of 120Ohm (minimum 1/4 W) between terminals 2 and 3. Figure 1 shows a signal line connection diagram (the fixture in the figure is an example picture and does not represent the real appearance of this product).

IMPORTANT: The wires must not make contact with each other or with the metal casing of the connectors. The casing itself must be connected to the shield braid and to pin 1 of the connectors.

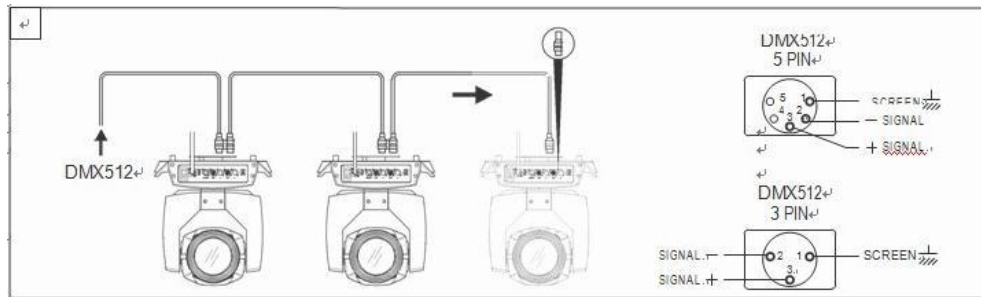

Figure 1 DMX Cable connection

5. Rigging (Optional)

As shown in Figure 2 (the fixture in the figure is an example picture and does not represent the real appearance of this product), this equipment can be positioned and fixed by clamp in every direction of the stage. Locking system makes it easy to fasten to the bracket.

Attention! Two clamps is needed to fix the equipment. Every clamp is locked by fastener of 1/4 kind. Fastener can only be locked clockwise.

Attention! Fasten a safety string to the additional hole of side aluminum piece. The secondary accessory can not hang on the delivery handle. Nip the equipment on bracket.

- Check if rigging clamp (not including the one inside) damaged or not? If stand ten times weight as the equipment. Make sure the architecture can stand ten times weight as all the equipments, clamps, wirings and other additional fixtures.
- Screws for clamping must be fixed firmly. Take one M12 screw (Grade 8.8 or higher) to clamp bracket, and then screw the nuts.
- Level the two hanging points at the bottom of clamp. Insert fastener to the bottom, lock the two levers by 1/4 rotating clockwise; then install another clamp.
- Install on safety string which stands at least ten times weight as equipment. Terminal of the accessory is designed for clamps.
- Make sure pan/tilt lock unlocked or not. Keep the distance more than 1M from equipment to flammable material or lighting source.

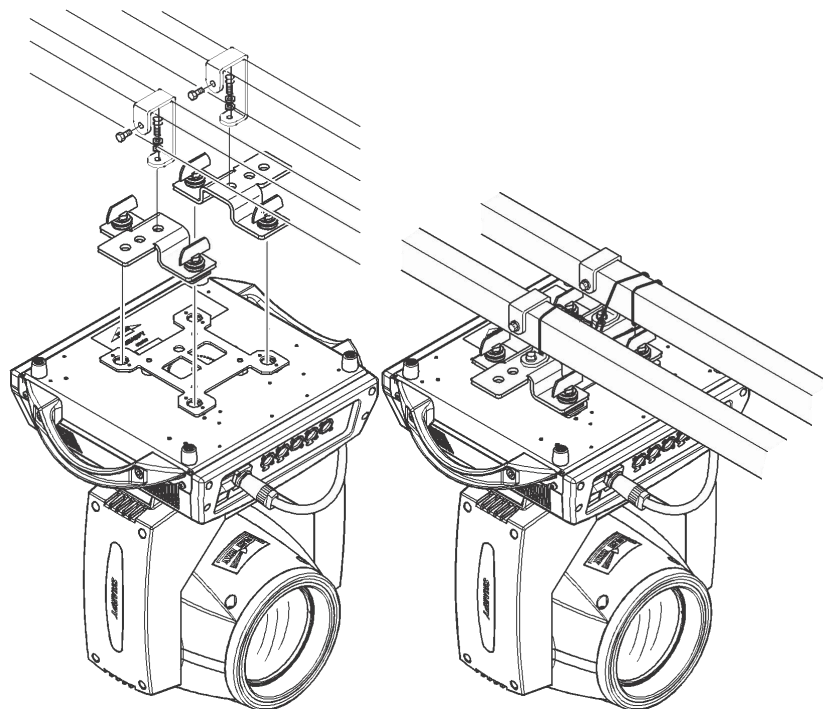

Figure 2 Installation

6. RDM Note

RDM is an extended version of DMX512-A protocol. It is a remote device management protocol. Traditional DMX512 protocol communication is one-way communication. The protocol is based on RS-485 bus. RS-485 is a time-sharing multi-point, half-duplex protocol. Only one port is allowed to output at the same time. So, when using RDM, we should pay attention to it. The following points:

- To use console or host device that supports RDM host protocol.
- Use bidirectional signal amplifier, traditional one-way signal amplifier is not suitable for RDM protocol, because the RMD protocol needs feedback data, the use of one-way amplifier will block the return of data, resulting in no search fixture;
- All fixture must be set to DMX mode to ensure only one host on the cable.
- A 120 ohm impedance matching resistor must be inserted between terminals 2 and 3 of the terminal plug. When the signal line is longer, reducing the signal reflection will make the differential signal more stable and beneficial to the quality of communication.
- When the fixture appears to accept DMX control, but can not been search by RDM host, first check the signal amplifier, and then check whether the signal line 2, 3 lines have bad contact.

Chapter 2 Panel operation

1. Brief

The light panel diagram show as Figure 3, above area is Title for fixture description, the black font in the lower right corner shows the fault status of the fixture (when the fault information is not viewed, it displays "ERR", otherwise it displays "NOR"), and the status bar below shows the signal of the current fixture , lamp status, communication status, etc. (the panel in the figure is an example picture and does not represent the real appearance of the product panel , please select a panel of the same type as your product for reference.).

RDM protocol is embed in fixture, user set DMX address via cable using the controller support RDM function. when fixture was search by controller, displayer will echo 'RDM' indicate this RDM is work.

Note: Prevent damage the touch or TFT displayer, Can not use sharp objects chick displayer.

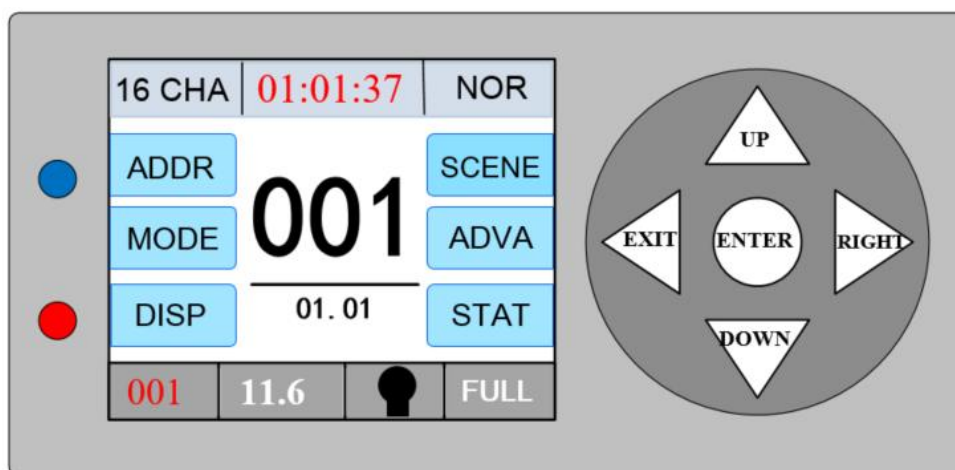

Figure 3-1 Five-buttons Panel diagram

2. Operation

1. Operate fixture with touch knob or button

- The left area is the display area, the right area is the input area, you can use the key or knob to control the cursor to select the item that needs to be set or viewed, and press the OK key to complete the operation.
- For the knob shown in Figure 3-3, the cursor can be controlled up or down by rotating in different directions, and pressing the knob can confirm it. If you want to go back, turn the knob to move the cursor to the back button on the display, press the knob to confirm and return.

2. Parameter value setting

When the selected item is value need to be modified, the dialog shown in Figure 4 will popup.



Figure 4 Dialog of value setting

- **Modify value:** The desired value can be set by pressing the "Up" and "Down" buttons or by turning the knob.
- **Save Value:** After setting the data by pressing the button, press the "ENTE" button, the values are immediately saved to the internal memory, and the saved values are applied to the fixture the next time the machine is turned on.

3. Boolean parameter setting

- when the selected parameters is a Boolean value (such as ON or OFF), can directly modify setting by chick corresponding item, the setting will been saved right now.
- When the parameter is a key item, chick corresponding item, a dialog shown in Figure 5 will been popup ask for the confirm. Chick 'sure' to confirm.

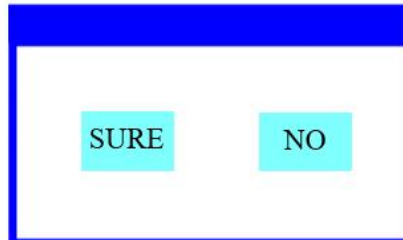

Figure 5 Dialog of confirm

4. Sub Menu (Parameter)



Figure 6-1 Address setting

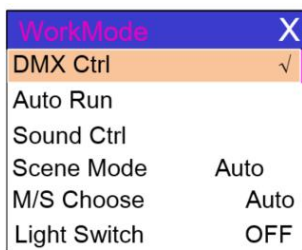

Figure 6-2 Run Settings

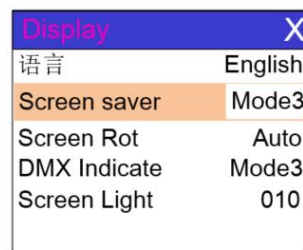

Figure 6-3 Display Settings

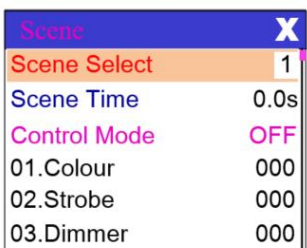

Figure 6-4 Scene Settings



Figure 6-5 Advanced setting

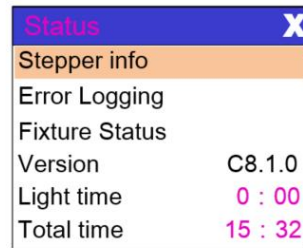

Figure 6-6 Status Settings

Figure 6 Parameter menu

3. Operation and parameter instruction

In the main interface, you can enter the corresponding parameter setting interface by selecting six buttons.

1. DMX Address setting

Enter page show in Figure6-1, can set fixture DMX address, channel mode and so on.



Figure 6-1

The menu settings of fixture have optimized the setting of addresses. Several settings of the address are as follows:

- Select " Prev " or "Next", the fixture will be based on the current address and channel mode, automatically calculate the next or last address, make address setting can quickly;
- Click on the address value, you can enter the numeric editing window, where you can set any valid address, fixture system automatically get the current number of channels, automatically filter the unusable address (512 - the current number of channels).
- Fixture support RDM protocol, remote address can be set through RDM.

Provide one buttons:

- Channel mode:: you can choose different channel modes by cycle.

2. Fixture operating mode setting



Figure 6-2

Through the page shown in Figure 6-2, the operating mode of the fixture can be set and the lamp can be controlled. The fixture supports four operating modes (DMX mode, auto mode, voice control mode and scene mode). Detailed parameter settings can be refer in the previous section. Specific parameter descriptions are as follows:

operating mode

DMX Ctrl	DMX mode, receive DMX signal, RDM signal	
Auto Run	Fixture run automatically according to built-in programs	
Sound Ctrl	When the fixture detects a strong sound, the fixture automatically runs a scene according to the built-in program, otherwise it will stay the last scene	
Scene Mode 01	runs in a set scene, which supports most of the custom editing of 10 scenes.	
	1~10	outputs the specified scene
	Auto	Automatically loops the output scene in the set scene time (non-zero) order, and the scene with time 0 automatically ignore
M/S Choose	Master and slave selection, non-DMX mode takes effect, select the mode of data output, fixture detect DMX cable state automatic switch output, prevent data conflicts	
	Master	fixture runs built-in program. If DMX has no signal, it outputs data (synchronization), otherwise it does not output data.
	Slave	fixture runs built-in program and do not output data
	Auto	If DMX has no signal, the fixture will runs built-in program. Otherwise, the fixture will run in DMX Mode(follow DMX).
Lamp switch	(Lamp light source) pop-up confirmation dialog box, select "SURE" to confirm the current operation, turn on or off the lamp, switch time interval limited to 30 seconds	
	Off	the current lamp output is off
	On	The current lamp output is turned on

Scene mode applies to a single or a small number of fixture, just output a fixed scene, or need to run a simple program, you no need connect to the console, in the scene page can be edited.

If the light source is lamp, wait for 10 minutes before turning off the lamp.

3. Set display

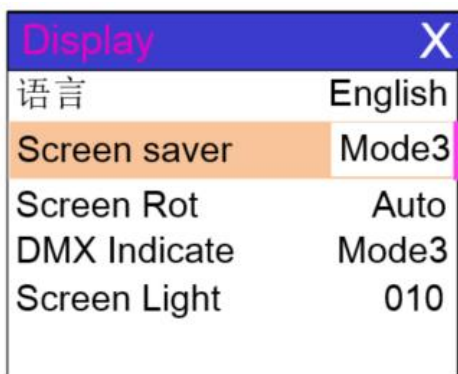

Figure 6-3

The fixture support Chinese and English, invert display and so on. Enter the corresponding parameter settings as shown in Figure 6-3. The specific menu contents are as follows:

DISPLAY SETTING

Language	display language settings	
	English	English display
	Chinese	Chinese display
Screen saver	Set screen 30 seconds without operation, the screen's display content or method.	
	OFF	Keep the last operation page
	Mode1	Black
	Mode2	Black screen, showing the address code of the current fixture in the lower left corner.
	Mode3	Display trademark information, address code and operation mode.
	Mode4	Display trademark information, address code and operation mode, which lasts for 30 seconds, black screen.
Screen Rot	Set the display direction of the screen.	
	OFF	No reverse display
	ON	Reverse display
DMX Indicate	Set the indication mode of DMX signal indicator.	
	Mode1	When signal is bright, no signal is off.
	Mode2	When signal is off, no signal is bright.
	Mode3	When signal is flash, no signal is off.
Screen Light	Set the screen backlight for 10 seconds without operation	
	1~10	10

4. Scene

Enter the page shown in Figure 6-4 (The channel shown in the picture is only an example of the function, please refer to the channel table description in the next section for the specific channel table of this product), and the fixture enters the scene editing mode. For example, under this page, when the [Control Mode] option is turned off, the fixture does not receive DMX console data, and the edited data will effect on the fixture immediately. When it turned on, the console signal is received and the console data is read and reflected on the corresponding channel display.

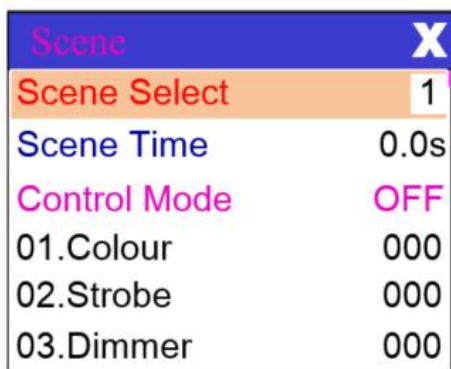

Figure 6-4

The content of the page depends on the currently selected channel mode, and the channel content and order displayed are consistent with the fixture channel table. Through this page, you can edit 10 scenes, as shown in the following table:

SCENE MODE

Scene Select	Select the current operation scenario.	
	1~10	The 10 scenes sets the format
Scene Time	Sets the retention time of the current scene when it is automatic,the final time is determined by the scene time multiplier, unit in 0.1 seconds.	
	0	The current scene is not output in automatic scene output.
	1-255	0..1s-25.5s
Control Mode	Choose whether to use the console to manipulate the settings data	
	OFF	It is not possible to control the console and set the data directly from the current interface
	ON	Using console control, the console data comes first when setting, and the setting is invalid in the current interface
1. PAN	0-255	Set up the data of each channel, and the contents and order of the display are one-to-one correspondence with the channel list of fixture.
.....	0-255	
.....	0-255	
N. Function	0-255	

If the reset channel in the scene edits the effective reset data, the fixture will reset, but after reset, the corresponding reset channel value will automatically set 0, preventing multiple consecutive resets.

Looking at this page, you can get the current channel table slot of the fixture. For specific channel data, please refer to the detailed channel description.

5. Set light run parameter

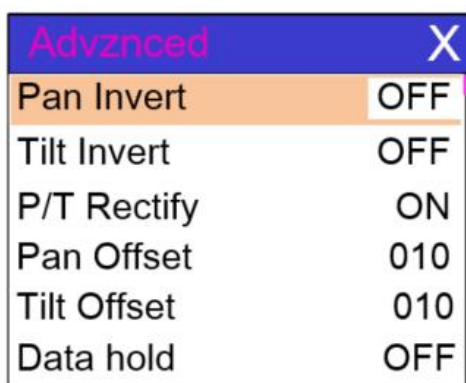

Figure 6-5

Enter the page shown in Figure 6-5, adjust the field parameters of fixture, facilitate the installation of fixture, etc.

ADVANCED SETTING

Pan Invert	Set the rotation direction of PAN	
	OFF	
	ON	
Tilt Invert	Set the rotation direction of TILT	
	OFF	
	ON	
P/T Rectify	Setting up fixture to detect XY lost step and correct	
	OFF	Uncorrected position after out of step
	ON	After losing step, the position is automatically corrected and the out of step fault is recorded.
Pan Offset	Setting the zero point of the PAN of the fixture	
	4-150	
Tilt Offset	Setting the zero point of the TILT of the fixture	
	4-48	
Data hold	When the fixture is not equipped with DMX signal, the output state of the fixture	
	OFF	No signal, so the motor and light source return to the position and state when reset is completed.
	NO	No signal, keep the last frame DMX data output.
Scene Time (multiple)	Work with the scene time to determine the scene retention time	
	1-255	Retention time = Scene time * multiple
Lamp mode	(lamp light source) Set the way to first open the lamp after power up	
	Power on	Turn on the lamp at power up and reset the lamp after 30 seconds.
	After reset	Reset the fixture after 3 seconds when power-on, and turn on the lamp after reset.
	Manual	After reset, manually turn on the lamp through the menu or console.
Reset	Pop up the confirmation box, select "SURE", and reset the fixture.	
Factory Setting	Pop up the confirmation box, select "SURE", and return the lamp parameters to the	

	factory settings.
--	-------------------

When choosing power-on mode, the lamp will wait for 30 seconds after power-on, let the lamp fully start, internal voltage is stable enough, then start the reset program, if the field capacity is stable, recommend power-on mode.

When the fixture can not calibrate the position, please check whether the "P/T Rectify" is turned off.

When the signal is unplugged, check the Data Hold setting first if the position of the fixture is not output as expected.

When setting the XY offset, after setting up, please control XY with the maximum stroke first to check that XY will not bump into the positioning rod or shell.

6. Status and information

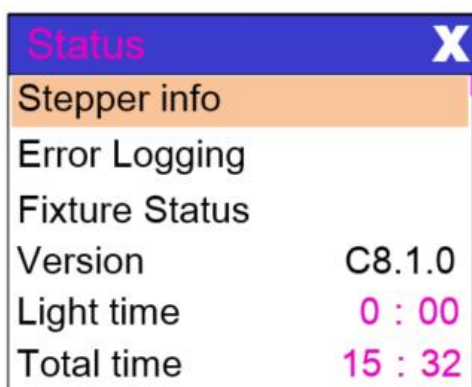

Figure 6-6

Entering the page shown in Figure 6-6, you can view the information and real-time status of the fixture to get their usage status. If the fixture need customer service, please provide the status information displayed on the page as a basis for judgment, as shown in the following table:

STATUS INFORMATION

Stepper info	Display information status of all motors and signals in fixture.	
	Hall	No display, indicating that the motor has no Hall, 0 indicating that the motor leaves the correction position point, 1 indicating that the motor is in the correction position point
	Status	Display motor reset status
	PAN	Display real-time position value of PAN optocoupler feedback
	TILT	Display real-time position value of TILT optocoupler feedback
	PAN OP	Displays the PAN TILT optocoupler two signal level state, binary
Error Logging	Show the latest 8 error records when the fixture is reset and running. The error records are not saved after power failure. The current power cycle is valid.	
	Error Logging	Total number of failures detected after power on
	12: :03	The time of power failure when the fault occurs is in minutes.
	Hall error	The effective hall signal is not detected when the motor is reset
	Hall short	When the motor is reset, the hall signal of the motor is always effective
	Opti error	No effective optocoupler signal is detected when the motor is reset.
	Lose stop	The corresponding motor is out of step during its operation.

	Hit	Striking the positioning rod when the motor is reset
	Lamp error	Lamp explosion accident
	NTC error	The temperature sensor signal is abnormal
	Fan error	The main fan is not working properly.
Fixture status	Displays the critical state data of the current fixture for reference.	
	Communication prec	0~100%, Communication quality of internal data link of lamps and lanterns
	Error Cnt	The number of erroneous frames was detected after power on, and the total number of erroneous frames was detected.
	Light Temperature	Show the temperature of the current light source, "---" means no detection.
	Panel Temperature	Displays the temperature of the current display panel or the ambient temperature.
	Sensor1 Temperature	Display the ambient temperature of the motherboard temperature or the motherboard installation position.
Version	Display the information and version of the current fixture, important reference for after sales maintenance.	
	Device	The name of the fixture is the same as the equipment information of RDM.
	Model	The type of fixture is the same as the model information of RDM.
	Panel	Firmware version and serial number of display panel
	Main Board	Firmware version and serial number of mother board 1
Light time	Record the total cumulative time of light source opening, unit minute, user manual cleaning, as a reference for regular maintenance of light source time.	
Total time	The total accumulated time for recording the opening of fixture is not allowed to be removed.	

Chapter 3 Channel description

1. Channel table

Note: the channel tables of different lamps are different. The following channel tables are for reference only

This luminance channel can be viewed in scene mode in order, channel mode is set in the "Address Settings" page, specific details of the data as follows:

CHANNEL TABLE

LIST-1	NAME	VALUE	BRIEF
[CH1]	Colour	0-4	White
		5-9	White+colour1
		10-14	Colour1
		15-19	Colour1+Colour2
		20-24	Colour2
		25-29	Colour2+Colour3
		30-34	Colour3
		35-39	Colour3+Colour4
		40-44	Colour4
		45-49	Colour4+Colour5
		50-54	Colour5
		55-59	Colour5+Colour6
		60-64	Colour6
		65-69	Colour6+Colour7
		70-74	Colour7
		75-79	Colour7+Colour8
		80-84	Colour8
		85-89	Colour8+Colour9
		90-94	Colour9
		95-99	Colour9+Colour10
		100-104	Colour10
		105-109	Colour10+Colour11
		110-114	Colour11
115-119	Colour11+Colour12		
120-124	Colour12		
125-129	Colour12+Colour13		
130-134	Colour13		
135-139	Colour13+Colour14		
140-144	Colour14		
145-149	Colour14+Colour15		
150-200	Rotate forward (fast to slow)		
201-255	Rotate reverse (slow to fast)		
[CH2]	Strobe	0-3	Dark

		4-103	Pluse strobe slow to fast
		104-107	Open
		108-207	Fade strobe slow to fast
		208-212	Open
		213-251	Rand strobe slow to fast
		252-255	Open
[CH3]	Dimmer	0-255	0-100% dimmer
[CH4]	Gobo	0-4	White
		5-9	Gobo1
		10-14	Gobo2
		15-19	Gobo3
		20-24	Gobo4
		25-29	Gobo5
		30-34	Gobo6
		35-39	Gobo7
		40-44	Gobo8
		45-49	Gobo9
		50-54	Gobo10
		55-59	Gobo11
		60-64	Gobo12
		65-69	Gobo13
		70-74	Gobo14
		75-79	Gobo15
		80-84	Gobo16
		85-89	Gobo17
		90-128	Rotate reverse (fast to slow)
		129-131	Stop
		132-170	Rotate forward (slow to fast)
		171-175	Shake slow to fast Gobo1
		176-180	Shake slow to fast Gobo2
		181-185	Shake slow to fast Gobo3
		186-190	Shake slow to fast Gobo4
		191-195	Shake slow to fast Gobo5
		196-200	Shake slow to fast Gobo6
		201-205	Shake slow to fast Gobo7
		206-210	Shake slow to fast Gobo8
		211-215	Shake slow to fast Gobo9
216-220	Shake slow to fast Gobo10		
221-225	Shake slow to fast Gobo11		
226-230	Shake slow to fast Gobo12		
231-235	Shake slow to fast Gobo13		
236-240	Shake slow to fast Gobo14		
241-245	Shake slow to fast Gobo15		

		246-250	Shake slow to fast Gobo16
		251-255	Shake slow to fast Gobo17
[CH5]	Prism1	0-127	None
		128-255	Inert prism1
[CH6]	Prism2	0-127	None
		128-255	Insert prism2
[CH7]	Prism1.R	0-127	0-360(degree)
		128-190	Rotate forward (fast to slow)
		191-192	Stop
		193-255	Rotate reverse (slow to fast)
[CH8]	Frost	0-127	None
		128-191	atomize
		192-255	colorful
[CH9]	Focus	0-255	Far to near
[CH10]	Pan	0-255	0-540(degree)
[CH11]	Pan Fine	0-255	0-2(degree)
[CH12]	Tilt	0-255	0-270(degree)
[CH13]	Tilt Fine	0-255	0-1(degree)
[CH14]	PT Spd	0-255	Fast to slow
[CH15]	Reset	0-25	None
		26-76	Reset Effect motor over 3 second
		77-127	Reset XY motor over 3 second
		128-255	Reset fixture over 3 second
[CH16]	Lamp	0-25	None
		26-100	Turn off lamp over 3 second
		101-255	Turn on over 3 second

Technical Parameters:

Power supply: 450W

Light source: 300W

Pattern: 16 patterns (5 glass patterns) + white light

Color: 14 colors + white light

Prism 1: 8 prisms

Prism 2: Cellular Prism

DMX: straight forward, voice control, master-slave

Superior energy effect: quantitative, colorful

X-axis: 540°

Y-axis: 270°