

COLLATED SCREW

MORE THAN JUST LOW PRICE!



**COLLATED SCREW NEEDLE POINT
BUGLE HEAD FINE THREAD YZ**

EZI ORDER	SIZE	QTY.
6-CN101	6G-18x25mm	1000
6-CN102	6G-18x32mm	1000
6-CN103	6G-18x41mm	1000



**COLLATED SCREW SD SELF EMBED
HAED ZINC**

EZI ORDER	SIZE	QTY.
6-CN110	8G-15x20mm	1000
6-CN111	8G-15x30mm	1000



**COLLATED SCREW NEEDLE POINT
BUGLE HEAD COARSE THREAD YZ**

EZI ORDER	SIZE	QTY.
6-CN104	6G-9x25mm	1000
6-CN105	6G-9x32mm	1000
6-CN106	6G-9x41mm	1000



**COLLATED SCREW SD SELF EMBED
HAED ZINC**

EZI ORDER	SIZE	QTY.
6-CN112	8G-15x20mm	1000
6-CN113	8G-15x30mm	1000



**COLLATED SCREW SD BUGLE HEAD
FINE THREAD YZ**

EZI ORDER	SIZE	QTY.
6-CN107	6G-20x25mm	1000
6-CN108	6G-20x32mm	1000
6-CN109	6G-20x41mm	1000



**SIMPSON STRONG-TIE QUICK DRIVE
TIMBER TO METAL SCREW**

EZI ORDER	SIZE	QTY.
6-TM101	8Gx42mm	1500
6-TM102	10Gx42mm	1500



* Brands subject to availability

COACH SCREW

MORE THAN JUST LOW PRICE!

**COACH SCREW HEX CL4.6 GAL**

EZI ORDER	SIZE	QTY.
6-CH101	M6x25mm	100
6-CH102	M6x30mm	100
6-CH103	M6x40mm	100
6-CH104	M6x50mm	100
6-CH105	M6x65mm	100
6-CH106	M6x75mm	100
6-CH107	M8x30mm	100
6-CH108	M8x40mm	100
6-CH109	M8x50mm	100
6-CH110	M8x65mm	100
6-CH111	M8x75mm	100
6-CH112	M8x100mm	100
6-CH113	M8x130mm	100
6-CH114	M10x40mm	100
6-CH115	M10x50mm	100
6-CH116	M10x65mm	100
6-CH117	M10x75mm	100
6-CH118	M10x90mm	100
6-CH119	M10x100mm	50
6-CH120	M10x120mm	50
6-CH121	M10x130mm	50
6-CH122	M10x150mm	50
6-CH123	M12x40mm	25
6-CH124	M12x50mm	25
6-CH125	M12x65mm	25
6-CH126	M12x75mm	25
6-CH127	M12x90mm	25
6-CH128	M12x100mm	25
6-CH129	M12x120mm	25
6-CH130	M12x130mm	25
6-CH131	M12x150mm	25
6-CH132	M12x180mm	25
6-CH133	M12x200mm	25
6-CH134	M16x50mm	25
6-CH135	M16x75mm	25
6-CH136	M16x90mm	25
6-CH137	M16x100mm	25
6-CH138	M16x130mm	25
6-CH139	M16x150mm	25
6-CH140	M16x200mm	25

**COACH SCREW HEX CL4.6 ZINC**

EZI ORDER	SIZE	QTY.
6-CH141	M8x30mm	100
6-CH142	M8x40mm	100
6-CH143	M8x50mm	100
6-CH144	M8x65mm	100
6-CH145	M8x75mm	100
6-CH146	M8x100mm	100
6-CH147	M10x40mm	100
6-CH148	M10x50mm	100
6-CH149	M10x65mm	100
6-CH150	M10x75mm	100
6-CH151	M10x90mm	100
6-CH152	M10x100mm	50
6-CH153	M10x120mm	50
6-CH154	M10x130mm	50
6-CH155	M10x150mm	50
6-CH156	M12x50mm	25
6-CH157	M12x65mm	25
6-CH158	M12x75mm	25
6-CH159	M12x90mm	25
6-CH160	M12x100mm	25
6-CH161	M12x130mm	25
6-CH162	M12x150mm	25
6-CH163	M12x200mm	25



* Brands subject to availability

COACH SCREW TYPE 17 SCREW

MORE THAN JUST LOW PRICE!



COACH SCREW HEX S316

EZI ORDER	SIZE	QTY.
6-CD830	M8x30mm	50
6-CD840	M8x40mm	50
6-CD850	M8x50mm	50
6-CD865	M8x65mm	50
6-CD875	M8x75mm	50
6-CD810	M8x100mm	50
6-CD104	M10x40mm	50
6-CD105	M10x50mm	50
6-CD106	M10x65mm	25
6-CD107	M10x75mm	25
6-CD110	M10x100mm	25
6-CD102	M10x120mm	25
6-CD113	M10x130mm	25
6-CD115	M10x150mm	25
6-CD118	M10x180mm	25
6-CD124	M12x40mm	25
6-CD125	M12x50mm	25
6-CD126	M12x65mm	25
6-CD127	M12x75mm	25
6-CD121	M12x100mm	25
6-CD122	M12x120mm	25
6-CD123	M12x130mm	25
6-CD120	M12x150mm	25
6-CD128	M12x180mm	25
6-CD161	M16x100mm	25
6-CD163	M16x130mm	25



T17 SCREW CSK HEAD C3

EZI ORDER	SIZE	QTY.
6-TC201	10G-12x40mm	50
6-TC202	10G-12x50mm	50
6-TC203	10G-12x40mm	1000
6-TC204	10G-12x50mm	500



T17 SCREW HEX HEAD ZY

EZI ORDER	SIZE	DRIVE	QTY.
6-TH101	12G-11x25mm	5/16"	500
6-TH102	12G-11x40mm	5/16"	1000
6-TH103	12G-11x50mm	5/16"	1000
6-TH104	12G-11x65mm	5/16"	1000



T17 SCREW BUGLE HEAD BATTEN ZY

EZI ORDER	SIZE	QTY.
6-TB101	14G-10x50mm	25
6-TB102	14G-10x75mm	25
6-TB103	14G-10x100mm	25
6-TB104	14G-10x50mm	100
6-TB105	14G-10x75mm	100
6-TB106	14G-10x100mm	100
6-TB107	14G-10x50mm	500
6-TB108	14G-10x75mm	500
6-TB109	14G-10x100mm	250



T17 SCREW WAFER HEAD ZY

EZI ORDER	SIZE	QTY.
6-TW101	10G-12x25mm	100
6-TW102	10G-12x35mm	50
6-TW103	10G-12x45mm	50
6-TW104	10G-12x25mm	1000
6-TW105	10G-12x35mm	1000
6-TW106	10G-12x45mm	500



T17 SCREW PAN HEAD ZY

EZI ORDER	SIZE	QTY.
6-TP101	8G-15x20mm	1000
6-TP102	8G-15x25mm	1000

TYPE 17 SCREW

MORE THAN JUST LOW PRICE!

**T17 SCREW CSK ZY**

EZI ORDER	SIZE	QTY.
6-TC101	6G-18x25mm	100
6-TC102	8G-15x25mm	100
6-TC103	10G-12x30mm	50
6-TC104	10G-12x40mm	50
6-TC105	10G-12x50mm	50
6-TC106	10G-12x75mm	50
6-TC107	6G-18x25mm	1000
6-TC108	8G-15x20mm	1000
6-TC109	8G-15x25mm	1000
6-TC110	10G-12x30mm	1000
6-TC111	10G-12x40mm	1000
6-TC112	10G-12x50mm	500
6-TC113	10G-12x75mm	1000

**T17 SCREW BUGLE HEAD BATTEN IHX C3**

EZI ORDER	SIZE	QTY.
6-TB201	14G-10x50mm	25
6-TB202	14G-10x75mm	25
6-TB203	14G-10x100mm	25
6-TB204	14G-10x125mm	25
6-TB205	14G-10x150mm	25
6-TB206	14G-10x50mm	100
6-TB207	14G-10x75mm	100
6-TB208	14G-10x100mm	100
6-TB209	14G-10x125mm	100
6-TB210	14G-10x150mm	100
6-TB211	14G-10x50mm	500
6-TB212	14G-10x75mm	500
6-TB213	14G-10x100mm	250
6-TB214	14G-10x125mm	250
6-TB215	14G-10x150mm	250

**T17 SCREW HEX HEAD C3**

EZI ORDER	SIZE	DRIVE	QTY.
6-TH201	10G-12x25mm	5/16"	50
6-TH202	12G-11x50mm	5/16"	50
6-TH203	12G-11x65mm	5/16"	50
6-TH204	14G-10x75mm	3/8"	100
6-TH205	14G-10x100mm	3/8"	100
6-TH206	10G-12x25mm	5/16"	500
6-TH207	12G-11x25mm	5/16"	1000
6-TH208	12G-11x35mm	5/16"	1000
6-TH209	12G-11x40mm	5/16"	1000
6-TH210	14G-10x65mm	3/8"	500
6-TH211	14G-10x90mm	3/8"	500
6-TH212	14G-10x100mm	3/8"	500
6-TH213	14G-10x150mm	3/8"	500

**T17 SCREW WAFER HEAD C3**

EZI ORDER	SIZE	QTY.
6-TW271	10G-12x25mm	100
6-TW272	10G-12x35mm	50
6-TW273	10G-12x45mm	50
6-TW274	10G-12x25mm	1000
6-TW275	10G-12x35mm	1000
6-TW276	10G-12x45mm	500

**T17 SCREW TIMBER DECKING TOP COAT C4**

EZI ORDER	SIZE	QTY.
6-TT201	9G-9x53mm	100
6-TT202	9G-9x53mm	250



* Brands subject to availability

TYPE 17 SCREW

MORE THAN JUST LOW PRICE!

TYPE 17 SCREW



T17 SCREW HEX HEAD WASHERED C3

EZI ORDER	SIZE	DRIVE	QTY.
6-TW201	12G-11x25mm	5/16"	50
6-TW202	12G-11x30mm	5/16"	50
6-TW203	12G-11x35mm	5/16"	50
6-TW204	12G-11x45mm	5/16"	50
6-TW205	12G-11x50mm	5/16"	50
6-TW206	12G-11x65mm	5/16"	50
6-TW207	14G-10x25mm	3/8"	50
6-TW208	14G-10x50mm	3/8"	25
6-TW209	14G-10x65mm	3/8"	25
6-TW210	14G-10x75mm	3/8"	25
6-TW211	14G-10x90mm	3/8"	25
6-TW212	14G-10x100mm	3/8"	25
6-TW213	12G-11x25mm	5/16"	100
6-TW214	12G-11x45mm	5/16"	100
6-TW215	12G-11x50mm	5/16"	100
6-TW216	12G-11x65mm	5/16"	100
6-TW217	14G-10x50mm	3/8"	250
6-TW218	14G-10x65mm	3/8"	250
6-TW219	14G-10x75mm	3/8"	250
6-TW220	14G-10x90mm	3/8"	100
6-TW221	14G-10x100mm	3/8"	100
6-TW222	10G-12x25mm	5/16"	1000
6-TW223	12G-11x25mm	5/16"	500
6-TW224	12G-11x45mm	5/16"	1000
6-TW225	12G-11x50mm	5/16"	1000
6-TW226	12G-11x65mm	5/16"	1000
6-TW227	14G-10x50mm	3/8"	1000
6-TW228	14G-10x65mm	3/8"	1000
6-TW229	14G-10x75mm	3/8"	500
6-TW230	14G-10x90mm	3/8"	500
6-TW231	14G-10x100mm	3/8"	250
6-TW232	14G-10x150mm	3/8"	250



T17 SCREW HEX C3 TOP GRIP WASHERED

EZI ORDER	SIZE	DRIVE	QTY.
6-TW233	12G-11x50mm	5/16"	50
6-TW234	12G-11x65mm	5/16"	50
6-TW235	12G-11x50mm	5/16"	100
6-TW236	12G-11x65mm	5/16"	100
6-TW237	12G-11x50mm	5/16"	1000
6-TW238	12G-11x65mm	5/16"	1000



T17 SCREW HEX TOP GRIP C4

EZI ORDER	SIZE	DRIVE	QTY.
6-TH251	12G-11x50mm	5/16"	20
6-TH252	12G-11x65mm	5/16"	20
6-TH253	12G-11x50mm	5/16"	1000
6-TH254	12G-11x65mm	5/16"	1000



T17 SCREW HEX TOP GRIP CYCLONIC

EZI ORDER	SIZE	DRIVE	QTY.
6-TH257	14G-10x50mm	3/8"	500
6-TH258	14G-10x65mm	3/8"	500
6-TH259	14G-10x75mm	3/8"	400



T17 SCREW HEX ALL-IN-1 ROOFING C4

EZI ORDER	SIZE	DRIVE	QTY.
6-TH255	12G-11x50mm	5/16"	250
6-TH256	12G-11x65mm	5/16"	250



Large domed sealing washer to support and seal polycarbonate roofing



Expansion hole cutter creates a thermal expansion hole in the roofing sheet

* Brands subject to availability

1300 522 820

kangaroositesupplies.com.au

TYPE 17 SCREW

MORE THAN JUST LOW PRICE!**T17 SCREW HEX C4**

EZI ORDER	SIZE	DRIVE	QTY.
6-TH214	10G-12x25mm	5/16"	100
6-TH215	12G-11x25mm	5/16"	50
6-TH216	12G-11x35mm	5/16"	50
6-TH217	12G-11x40mm	5/16"	50
6-TH218	12G-11x50mm	5/16"	50
6-TH219	12G-11x65mm	5/16"	20
6-TH220	14G-10x25mm	3/8"	50
6-TH221	14G-10x75mm	3/8"	20
6-TH222	14G-10x100mm	3/8"	20
6-TH223	12G-11x40mm	5/16"	250
6-TH224	12G-11x50mm	5/16"	250
6-TH225	12G-11x65mm	5/16"	250
6-TH226	14G-10x50mm	3/8"	100
6-TH227	14G-10x65mm	3/8"	100
6-TH228	14G-10x75mm	3/8"	100
6-TH229	14G-10x90mm	3/8"	100
6-TH230	14G-10x100mm	3/8"	100
6-TH231	14G-10x115mm	3/8"	100
6-TH232	14G-10x125mm	3/8"	100
6-TH233	14G-10x150mm	3/8"	100
6-TH234	10G-12x25mm	5/16"	1000
6-TH235	12G-11x25mm	5/16"	500
6-TH236	12G-11x35mm	5/16"	1000
6-TH237	12G-11x40mm	5/16"	1000
6-TH238	12G-11x45mm	5/16"	1000
6-TH239	12G-11x50mm	5/16"	1000
6-TH240	12G-11x65mm	5/16"	1000
6-TH241	14G-10x25mm	3/8"	500
6-TH242	14G-10x40mm	3/8"	1000
6-TH243	14G-10x50mm	3/8"	1000
6-TH244	14G-10x65mm	3/8"	1000
6-TH245	14G-10x75mm	3/8"	500
6-TH246	14G-10x90mm	3/8"	500
6-TH290	14G-10x90mm	3/8"	200
6-TH247	14G-10x100mm	3/8"	250
6-TH248	14G-10x115mm	3/8"	250
6-TH249	14G-10x125mm	3/8"	250
6-TH250	14G-10x150mm	3/8"	250

**T17 SCREW HEX WASHERED C4**

EZI ORDER	SIZE	DRIVE	QTY.
6-TW239	10G-12x25mm	5/16"	100
6-TW240	12G-11x25mm	5/16"	50
6-TW241	12G-11x40mm	5/16"	50
6-TW242	12G-11x45mm	5/16"	50
6-TW243	12G-11x65mm	5/16"	20
6-TW244	14G-10x25mm	3/8"	50
6-TW245	14G-10x50mm	3/8"	20
6-TW246	14G-10x65mm	3/8"	20
6-TW247	14G-10x75mm	3/8"	20
6-TW248	14G-10x90mm	3/8"	20
6-TW249	14G-10x100mm	3/8"	20
6-TW250	14G-10x50mm	3/8"	250
6-TW251	14G-10x65mm	3/8"	250
6-TW252	14G-10x75mm	3/8"	250
6-TW253	14G-10x90mm	3/8"	250
6-TW254	10G-12x25mm	5/16"	1000
6-TW255	12G-11x25mm	5/16"	500
6-TW256	12G-11x35mm	5/16"	1000
6-TW257	12G-11x40mm	5/16"	1000
6-TW258	12G-11x45mm	5/16"	1000
6-TW259	12G-11x50mm	5/16"	1000
6-TW260	12G-11x65mm	5/16"	1000
6-TW261	14G-10x25mm	3/8"	500
6-TW262	14G-10x40mm	3/8"	1000
6-TW263	14G-10x50mm	3/8"	1000
6-TW264	14G-10x65mm	3/8"	1000
6-TW265	14G-10x75mm	3/8"	500
6-TW266	14G-10x90mm	3/8"	500
6-TW267	14G-10x100mm	3/8"	250
6-TW268	14G-10x115mm	3/8"	250
6-TW269	14G-10x125mm	3/8"	250
6-TW270	14G-10x150mm	3/8"	250



* Brands subject to availability

NEEDLE POINT SCREW

MORE THAN JUST LOW PRICE!



MULTI-PURPOSE SCREW CSK YZ

EZI ORDER	SIZE	QTY.
6-MP101	6G-12x20mm	100
6-MP102	6G-12x25mm	100
6-MP103	8G-10x20mm	100
6-MP104	8G-10x25mm	100
6-MP105	8G-10x30mm	100
6-MP106	8G-10x35mm	100
6-MP107	8G-10x40mm	100
6-MP108	8G-10x45mm	100
6-MP109	8G-10x50mm	50
6-MP110	8G-10x60mm	50
6-MP111	8G-10x65mm	50
6-MP112	8G-10x75mm	50
6-MP113	10G-8x100mm	50
6-MP114	10G-8x40mm	50
6-MP115	10G-8x50mm	50
6-MP116	10G-8x60mm	50
6-MP117	10G-8x65mm	50
6-MP118	10G-8x75mm	50
6-MP119	8G-10x20mm	500
6-MP120	8G-10x25mm	500
6-MP121	8G-10x30mm	500
6-MP122	8G-10x35mm	500
6-MP123	8G-10x40mm	500
6-MP124	8G-10x45mm	500
6-MP125	8G-10x50mm	500
6-MP126	8G-10x65mm	500
6-MP127	10G-8x50mm	500
6-MP128	10G-8x65mm	500
6-MP129	10G-8x75mm	500



SCREW NEEDLE POINT CSK NIBS YZ

EZI ORDER	SIZE	QTY.
6-NN101	8G-15x20mm	1000
6-NN102	8G-15x30mm	1000



SCREW NEEDLE POINT BUGLE HEAD FINE YZ

EZI ORDER	SIZE	QTY.
6-NB101	6G-18x20mm	100
6-NB102	6G-18x25mm	100
6-NB103	6G-18x30mm	100
6-NB104	6G-18x40mm	100
6-NB105	6G-18x50mm	100
6-NB106	7G-16x25mm	100
6-NB107	7G-16x30mm	100
6-NB108	7G-16x40mm	100
6-NB109	7G-16x50mm	100
6-NB110	8G-15x25mm	100
6-NB111	8G-15x30mm	100
6-NB112	8G-15x40mm	100
6-NB113	8G-15x50mm	50
6-NB114	8G-15x65mm	50
6-NB115	8G-15x75mm	50
6-NB116	6G-18x25mm	1000
6-NB117	6G-18x32mm	1000
6-NB118	6G-18x41mm	1000
6-NB119	8G-15x65mm	500
6-NB121	10G-10x100mm	50



SCREW NEEDLE POINT BUGLE HEAD YZ COARSE YZ

EZI ORDER	SIZE	QTY.
6-NB122	7G-9x25mm	1000
6-NB123	7G-9x32mm	1000
6-NB124	8G-9x45mm	1000
6-NB125	10G-8x35mm	1000
6-NB126	10G-8x38mm	1000
6-NB127	10G-8x50mm	1000

* Brands subject to availability

NEEDLE POINT SCREW

MORE THAN JUST LOW PRICE!



CHIPBOARD SCREW YZ NIBS

EZI ORDER	SIZE	QTY.
6-NC101	8G-9x25mm	1000
6-NC102	8G-9x28mm	1000
6-NC103	8G-9x32mm	1000
6-NC104	8G-9x40mm	1000
6-NC105	8G-9x45mm	1000
6-NC106	8G-9x50mm	1000
6-NC107	8G-10x57mm	1000
6-NC108	8G-10x65mm	500
6-NC109	8G-10x75mm	500
6-NC110	10G-10x65mm	500
6-NC111	10G-10x75mm	500
6-NC112	10G-10x100mm	250



SCREW NEEDLE POINT BUTTON HEAD YZ

EZI ORDER	SIZE	QTY.
6-NU101	8G-15x20mm	100
6-NU102	8G-15x25mm	100
6-NU103	8G-15x30mm	100
6-NU104	8G-15x12mm	1000
6-NU105	8G-15x15mm	1000
6-NU106	8G-15x20mm	1000
6-NU107	8G-15x25mm	1000
6-NU108	8G-15x32mm	1000



SCREW NEEDLE POINT MICRO FLATHEAD YZ

EZI ORDER	SIZE	QTY.
6-NM101	10G-15x16mm	1000

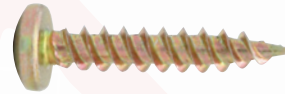

SCREW NEEDLE POINT PAN HEAD YZ

EZI ORDER	SIZE	QTY.
6-NP101	7G-16x20mm	100
6-NP102	6G-15x20mm	1000
6-NP103	7G-16x12mm	1000
6-NP104	7G-16x20mm	1000
6-NP105	7G-16x25mm	1000
6-NP106	7G-16x30mm	1000
6-NP107	7G-16x40mm	1000
6-NP108	7G-16x50mm	500



SCREW NEEDLE POINT BUTTON C3

EZI ORDER	SIZE	QTY.
6-NU201	8G-15x15mm	100
6-NU202	8G-15x20mm	100
6-NU203	8G-15x25mm	100
6-NU204	8G-15x30mm	100
6-NU205	8G-15x15mm	1000
6-NU206	8G-15x20mm	1000
6-NU207	8G-15x25mm	1000
6-NU208	8G-15x32mm	1000



SCREW NEEDLE POINT BUGLE HEAD C3 SQ2 DRIVE

EZI ORDER	SIZE	QTY.
6-NB201	8G-15x65mm	500
6-NB202	8G-15x75mm	500
6-NB203	10G-12x100mm	250
6-NB204	10G-12x130mm	250
6-NB205	10G-12x150mm	250

* Brands subject to availability

NEEDLE POINT SCREW

MORE THAN JUST LOW PRICE!



NYLON INSULATION WASHERS WITH SCREW GRIP-IN SYSTEM CLASS 4

EZI ORDER	SIZE	QTY.
6-SW201	45mm	500



SCREW NEEDLE POINT HEX SLOTTED ZY

EZI ORDER	SIZE	DRIVE	QTY.
6-NS101	8G-15x32mm	1/4"	1000
6-NS102	8G-15x32mm	1/4"	1000



SCREW NEEDLE POINT HEX HEAD C4

EZI ORDER	SIZE	DRIVE	QTY.
6-NH201	8G-15x12mm	1/4"	1000
6-NH202	10G-12x20mm	5/16"	1000



SCREW NEEDLE POINT HEX WASHERED C4

EZI ORDER	SIZE	DRIVE	QTY.
6-NW201	8G-15x12mm	1/4"	1000
6-NW202	10G-12x20mm	5/16"	1000



SCREW NEEDLE POINT MICRO FLATHEAD C3

EZI ORDER	SIZE	QTY.
6-NM201	10G-16x16mm	1000



SCREW SELF TAPPING ZP

EZI ORDER	SIZE	QTY.
6-ST101	4Gx10mm	100
6-ST102	4Gx12mm	100
6-ST103	6Gx12mm	100
6-ST104	6Gx16mm	100
6-ST105	6Gx18mm	100
6-ST106	6Gx25mm	100
6-ST107	6Gx30mm	100
6-ST108	8Gx10mm	100
6-ST109	8Gx12mm	100
6-ST110	8Gx15mm	100
6-ST111	8Gx20mm	100
6-ST112	8Gx25mm	100
6-ST113	8Gx30mm	100
6-ST114	8Gx40mm	100
6-ST115	8Gx50mm	50
6-ST116	10Gx12mm	100
6-ST117	10Gx16mm	100
6-ST118	10Gx20mm	100
6-ST119	10Gx25mm	100
6-ST120	10Gx30mm	100
6-ST121	10Gx40mm	50
6-ST122	10Gx50mm	50
6-ST123	12Gx12mm	100
6-ST124	12Gx20mm	100
6-ST125	12Gx25mm	100
6-ST126	12Gx30mm	50
6-ST127	12Gx40mm	50
6-ST128	14Gx20mm	100



SCREW NEEDLE POINT FLAT SERRATION HEAD C3

EZI ORDER	SIZE	QTY.
6-NF201	M6-24x15mm	1000

* Brands subject to availability

NEEDLE POINT SCREW SELF-DRILLING SCREW

MORE THAN JUST LOW PRICE!



CHIPBOARD SELF EMBED C3

EZI ORDER	SIZE	QTY.
6-EC201	8G-9x20mm	100
6-EC202	8G-9x25mm	100
6-EC203	8G-9x28mm	100
6-EC204	8G-9x32mm	100
6-EC205	8G-9x35mm	100
6-EC206	8G-9x40mm	100
6-EC207	8G-9x45mm	100
6-EC208	8G-9x50mm	100
6-EC209	8G-9x57mm	100
6-EC210	10G-8x65mm	50
6-EC211	10G-8x75mm	50
6-EC212	10G-8x100mm	50
6-EC213	8G-9x20mm	1000
6-EC214	8G-9x25mm	1000
6-EC215	8G-9x28mm	1000
6-EC216	8G-9x32mm	1000
6-EC217	8G-9x35mm	1000
6-EC218	8G-9x40mm	1000
6-EC219	8G-9x45mm	1000
6-EC220	8G-9x50mm	1000
6-EC221	8G-9x57mm	500
6-EC222	10G-8x65mm	500
6-EC223	10G-8x75mm	250
6-EC224	10G-8x100mm	250



SD SCREW CSK EMBED COARSE C3

EZI ORDER	SIZE	QTY.
6-SC285	8G-18x20mm	100
6-SC286	8G-18x30mm	100
6-SC287	8G-18x20mm	1000
6-SC288	8G-18x25mm	1000
6-SC289	8G-18x30mm	1000



SD SCREW HEX COARSE ZY

EZI ORDER	SIZE	DRIVE	QTY.
6-SC101	10G-16x16mm	5/16"	50
6-SC102	12G-14x20mm	5/16"	50
6-SC103	12G-14x25mm	5/16"	50
6-SC104	10G-16x16mm	5/16"	1000
6-SC105	12G-14x20mm	5/16"	500
6-SC106	12G-14x25mm	5/16"	1000

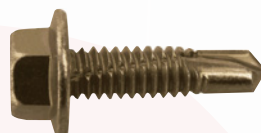

SD SCREW HEX FINE ZY

EZI ORDER	SIZE	DRIVE	QTY.
6-SH101	14G-20x25mm	3/8"	500



SD SCREW HEX BATTEN C3

EZI ORDER	SIZE	DRIVE	QTY.
6-SB201	12G-11x40mm	5/16"	100
6-SB202	12G-11x40mm	5/16"	1000



SD SCREW HEX FINE C3

EZI ORDER	SIZE	DRIVE	QTY.
6-SH201	14G-20x22mm	3/8"	50
6-SH202	12G-24x20mm	5/16"	1000
6-SH203	14G-20x22mm	3/8"	1000

SELF-DRILLING SCREW

MORE THAN JUST LOW PRICE!



SD SCREW CSK HEAD ZINC YW PH DRIVE

EZI ORDER	SIZE	QTY.
6-PD550	10G-24x50mm	500
6-PD565	10G-24x65mm	500



SD SCREW CSK COARSE ZY

EZI ORDER	SIZE	QTY.
6-SC107	10G-16x30mm	100
6-SC108	10G-16x40mm	100
6-SC109	10G-16x30mm	1000
6-SC110	10G-16x40mm	1000



SD SCREW WAFER COARSE ZY

EZI ORDER	SIZE	QTY.
6-SC111	10G-16x16mm	100
6-SC112	10G-16x22mm	100
6-SC113	10G-16x30mm	50
6-SC114	10G-16x16mm	1000
6-SC115	10G-16x22mm	1000
6-SC116	10G-16x30mm	1000
6-SC117	10G-16x40mm	1000
6-SC118	12G-14x18mm	1000



SD SCREW CSK EMBED ZY

EZI ORDER	SIZE	QTY.
6-SE101	8G-18x20mm	100
6-SE102	8G-18x30mm	100
6-SE103	8G-18x35mm	100
6-SE104	8G-18x20mm	1000
6-SE105	8G-18x30mm	1000



SD SCREW BUTTON COARSE ZY

EZI ORDER	SIZE	QTY.
6-SC119	8G-18x12mm	100
6-SC120	8G-18x16mm	100
6-SC121	8G-18x20mm	100
6-SC122	8G-18x25mm	100
6-SC123	8G-18x32mm	100
6-SC124	8G-18x12mm	1000
6-SC125	8G-18x16mm	1000
6-SC126	8G-18x20mm	1000
6-SC127	8G-18x25mm	1000
6-SC128	8G-18x32mm	1000



SD SCREW CSK FINE ZY

EZI ORDER	SIZE	QTY.
6-SF101	10G-24x30mm	50
6-SF102	10G-24x40mm	50
6-SF103	10G-24x50mm	50
6-SF104	10G-24x65mm	50
6-SF105	6G-20x50mm	1000
6-SF106	10G-24x30mm	1000
6-SF107	10G-24x40mm	1000
6-SF108	10G-24x50mm	500
6-SF109	10G-24x65mm	500



SD SCREW WAFER FINE ZY

EZI ORDER	SIZE	QTY.
6-SF110	10G-24x16mm	1000

* Brands subject to availability

SELF-DRILLING SCREW

MORE THAN JUST LOW PRICE!



SD SCREW MICRO FLAT HEAD YZ

EZI ORDER	SIZE	QTY.
6-SM101	10G-16x16mm	1000



SD SCREW HEX COARSE C3

EZI ORDER	SIZE	DRIVE	QTY.
6-SC201	8G-18x12mm	1/4"	100
6-SC202	10G-16x16mm	5/16"	100
6-SC203	10G-16x25mm	5/16"	50
6-SC204	12G-14x20mm	5/16"	50
6-SC205	12G-14x35mm	5/16"	50
6-SC206	12G-14x45mm	5/16"	50
6-SC207	12G-14x65mm	5/16"	50
6-SC208	10G-16x16mm	5/16"	100
6-SC209	12G-14x20mm	5/16"	100
6-SC210	12G-14x35mm	5/16"	100
6-SC211	14G-10x22mm	3/8"	100
6-SC212	10G-16x16mm	5/16"	1000
6-SC213	10G-16x25mm	5/16"	1000
6-SC214	12G-14x20mm	5/16"	1000
6-SC215	12G-14x35mm	5/16"	1000
6-SC216	12G-14x50mm	5/16"	1000



SD SCREW PAN COARSE ZY

EZI ORDER	SIZE	QTY.
6-SP101	6G-20x10mm	4000
6-SP102	8G-18x12mm	1000
6-SP103	8G-18x16mm	1000



SD SCREW BUGLE YZ

EZI ORDER	SIZE	QTY.
6-SB101	6G-20x25mm	100
6-SB102	6G-20x32mm	100
6-SB103	6G-20x45mm	100
6-SB104	6G-20x25mm	1000
6-SB105	6G-20x32mm	1000
6-SB106	6G-20x45mm	1000



SD SCREW HEX METAL/TIMBER WASHERED C4

EZI ORDER	SIZE	DRIVE	QTY.
6-SH233	13G-11x50mm	5/16"	20
6-SH234	13G-13x50mm	5/16"	100
6-SH235	13G-11x38mm	5/16"	1000
6-SH236	13G-11x50mm	5/16"	1000



SD SCREW CSK EMBED WING YZ

EZI ORDER	SIZE	QTY.
6-SE106	8G-18x40mm	100
6-SE107	10G-16x45mm	50
6-SE108	10G-16x55mm	50
6-SE109	6G-20x42mm	1000
6-SE110	10G-16x35mm	1000
6-SE111	10G-16x40mm	1000
6-SE112	10G-16x45mm	1000



SD SCREW HEX WASHERED TOP GRIP C3

EZI ORDER	SIZE	DRIVE	QTY.
6-SH229	12G-14x65mm	5/16"	100
6-SH230	12G-14x35mm	5/16"	500
6-SH231	12G-14x45mm	5/16"	500
6-SH232	12G-14x65mm	5/16"	500

* Brands subject to availability

SELF-DRILLING SCREW

MORE THAN JUST LOW PRICE!



SD SCREW HEX COARSE C4

EZI ORDER	SIZE	DRIVE	QTY.
6-SC217	10G-16x16mm	5/16"	100
6-SC218	10G-16x25mm	5/16"	100
6-SC219	12G-14x20mm	5/16"	50
6-SC220	12G-14x30mm	5/16"	50
6-SC221	14G-10x25mm	3/8"	50
6-SC222	14G-10x42mm	3/8"	20
6-SC223	14G-10x50mm	3/8"	20
6-SC224	14G-10x65mm	3/8"	20
6-SC225	14G-10x75mm	3/8"	20
6-SC226	8G-18x12mm	1/4"	1000
6-SC227	10G-16x16mm	5/16"	1000
6-SC228	10G-16x25mm	5/16"	1000
6-SC229	12G-14x20mm	5/16"	1000
6-SC230	12G-14x25mm	5/16"	500
6-SC231	12G-14x30mm	5/16"	1000
6-SC232	12G-14x35mm	5/16"	1000
6-SC233	12G-14x35mm	5/16"	1000
6-SC234	12G-14x45mm	5/16"	1000
6-SC235	12G-14x55mm	5/16"	1000
6-SC236	12G-14x65mm	5/16"	1000
6-SC237	12G-14x75mm	5/16"	500
6-SC238	14G-10x25mm	3/8"	500
6-SC239	14G-10x42mm	3/8"	1000
6-SC240	14G-10x50mm	3/8"	1000
6-SC241	14G-10x65mm	3/8"	1000
6-SC242	14G-10x75mm	3/8"	500
6-SC243	14G-10x95mm	3/8"	500
6-SC143	14G-10x95mm	3/8"	200
6-SC244	14G-14x115mm	3/8"	250
6-SC245	14G-14x125mm	3/8"	250
6-SC246	14G-14x135mm	3/8"	250
6-SC247	14G-14x150mm	3/8"	250
6-SC248	14G-14x175mm	3/8"	250
6-SC249	14G-14x205mm	3/8"	200

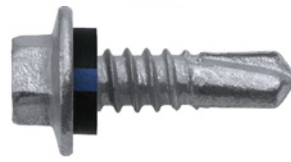

SD SCREW HEX COARSE WASHERED C4

EZI ORDER	SIZE	DRIVE	QTY.
6-SC250	10G-16x16mm	5/16"	100
6-SC251	10G-16x25mm	5/16"	100
6-SC252	12G-14x20mm	5/16"	50
6-SC253	12G-14x55mm	5/16"	20
6-SC254	12G-14x65mm	5/16"	20
6-SC255	14G-10x25mm	3/8"	20
6-SC256	14G-10x42mm	3/8"	20
6-SC257	14G-10x50mm	3/8"	20
6-SC258	14G-10x65mm	3/8"	20
6-SC259	14G-10x75mm	3/8"	20
6-SC260	14G-10x95mm	3/8"	20
6-SC261	8G-18x12mm	1/4"	1000
6-SC262	10G-16x16mm	5/16"	1000
6-SC263	10G-16x25mm	5/16"	1000
6-SC264	12G-14x25mm	5/16"	500
6-SC265	12G-14x20mm	5/16"	500
6-SC266	12G-14x35mm	5/16"	1000
6-SC267	12G-14x45mm	5/16"	1000
6-SC268	12G-14x55mm	5/16"	1000
6-SC269	12G-14x65mm	5/16"	1000
6-SC270	12G-14x75mm	5/16"	500
6-SC271	14G-10x25mm	3/8"	500
6-SC272	14G-10x42mm	3/8"	1000
6-SC273	14G-10x50mm	3/8"	1000
6-SC274	14G-10x65mm	3/8"	1000
6-SC275	14G-10x75mm	3/8"	500
6-SC276	14G-10x95mm	3/8"	500
6-SC277	14G-14x115mm	3/8"	250
6-SC278	14G-14x125mm	3/8"	250
6-SC279	14G-14x135mm	3/8"	250
6-SC280	14G-14x150mm	3/8"	250
6-SC281	14G-14x175mm	3/8"	250
6-SC282	14G-14x205mm	3/8"	200



SD SCREW WAFER HEAD FINE C3

EZI ORDER	SIZE	QTY.
6-SF244	10G-24x16mm	1000



* Brands subject to availability

SELF-DRILLING SCREW

MORE THAN JUST LOW PRICE!



SD SCREW CSK FINE C3

EZI ORDER	SIZE	QTY.
6-SF231	10G-24x40mm	50
6-SF232	10G-24x65mm	50
6-SF233	10G-24x30mm	1000
6-SF234	10G-24x40mm	1000
6-SF235	10G-24x50mm	500
6-SF236	10G-24x65mm	500
6-SF237	8G-18x30mm	50
6-SF238	8G-18x35mm	50
6-SF239	10G-16x30mm	100
6-SF240	10G-16x40mm	50
6-SF241	10G-16x30mm	1000
6-SF242	10G-16x40mm	1000
6-SF243	10G-16x50mm	500



SD SCREW MICRO FLAT HEAD C3

EZI ORDER	SIZE	QTY.
6-SM201	10G-16x16mm	100
6-SM202	10G-16x22mm	100
6-SM203	10G-16x30mm	100
6-SM204	10G-16x16mm	1000
6-SM205	10G-16x22mm	1000
6-SM206	10G-16x30mm	1000



SD SCREW WAFER HEAD COARSE C3

EZI ORDER	SIZE	QTY.
6-SC290	8G-18x12mm	100
6-SC291	8G-18x25mm	100
6-SC292	10G-16x16mm	100
6-SC293	10G-16x22mm	100
6-SC294	10G-16x30mm	50
6-SC295	10G-16x16mm	1000
6-SC296	10G-16x22mm	1000
6-SC297	10G-16x30mm	1000
6-SC299	10G-16x40mm	1000
6-SC200	12G-14x18mm	1000



SD SCREW BUTTON C3

EZI ORDER	SIZE	QTY.
6-SU201	8G-18x12mm	100
6-SU202	8G-18x16mm	100
6-SU203	8G-18x20mm	100
6-SU204	8G-18x25mm	100
6-SU205	8G-18x32mm	100
6-SU206	8G-18x12mm	1000
6-SU207	8G-18x16mm	1000
6-SU208	8G-18x20mm	1000
6-SU209	8G-18x25mm	1000
6-SU210	8G-18x32mm	1000

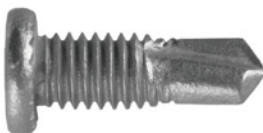

SD SCREW STEEL FRAME FINE C3

EZI ORDER	SIZE	QTY.
6-SS201	M6x18mm	1000



SD SCREW THICK FLAT HEAD C4

EZI ORDER	SIZE	QTY.
6-SK201	10G-24x16mm	1000

SELF-DRILLING SCREW

MORE THAN JUST LOW PRICE!



SD SCREW HEX TOP GRIP CYCLONIC C4

EZI ORDER	SIZE	DRIVE	QTY.
6-SH237	14G-10x42mm	3/8"	500
6-SH238	14G-10x55mm	3/8"	500
6-SH239	14G-10x65mm	3/8"	500
6-SH240	14G-13x57mm	3/8"	500



SD SCREW HEX ALL-IN-1 C4

EZI ORDER	SIZE	DRIVE	QTY.
6-SH241	12G-14x60mm	5/16"	250



SD SCREW HEX METAL/TIMBER C4

EZI ORDER	SIZE	DRIVE	QTY.
6-SH249	13G-11x25mm	5/16"	500



SD SCREW HEX TOP GRIP C4

EZI ORDER	SIZE	DRIVE	QTY.
6-SH242	12G-14x42mm	5/16"	20
6-SH243	12G-14x53mm	5/16"	20
6-SH244	12G-14x42mm	5/16"	250
6-SH245	12G-14x53mm	5/16"	250
6-SH246	12G-14x42mm	5/16"	1000
6-SH247	12G-14x53mm	5/16"	1000
6-SH248	12G-14x65mm	5/16"	1000

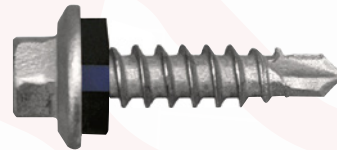

SD SCREW HEX METAL/TIMBER WASHERED C4

EZI ORDER	SIZE	DRIVE	QTY.
6-SH250	13G-11x25mm	5/16"	100
6-SH251	13G-11x25mm	5/16"	500



SD SCREW HEX FINE C4

EZI ORDER	SIZE	DRIVE	QTY.
6-SF201	12G-24x30mm	5/16"	50
6-SF202	14G-20x25mm	3/8"	50
6-SF203	14G-20x115mm	3/8"	10
6-SF204	10G-24x16mm	5/16"	1000
6-SF205	10G-24x25mm	5/16"	1000
6-SF206	12G-24x20mm	5/16"	1000
6-SF207	12G-24x30mm	5/16"	1000
6-SF208	14G-20x25mm	3/8"	500
6-SF209	14G-20x45mm	3/8"	1000
6-SF210	14G-20x65mm	3/8"	1000
6-SF211	14G-20x115mm	3/8"	250



SD SCREW REDUCED HEX COARSE C4

EZI ORDER	SIZE	DRIVE	QTY.
6-SC283	14G-14x22mm	3/8"	500



SD SCREW REDUCED HEX COARSE C3

EZI ORDER	SIZE	DRIVE	QTY.
6-SC284	12G-14x30mm	5/16"	500

* Brands subject to availability

SELF-DRILLING SCREW

MORE THAN JUST LOW PRICE!

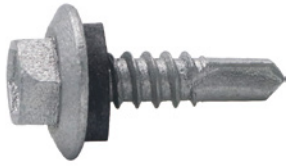

SD SCREW HEX WASHERED C3

EZI ORDER	SIZE	DRIVE	QTY.
6-SH204	8G-18x12 mm	1/4"	100
6-SH205	10G-16x16mm	5/16"	100
6-SH206	10G-16x25mm	5/16"	50
6-SH207	12G-14x20mm	5/16"	50
6-SH208	12G-14x25mm	5/16"	50
6-SH209	12G-14x35mm	5/16"	50
6-SH210	12G-14x45mm	5/16"	50
6-SH211	12G-14x50mm	5/16"	50
6-SH212	12G-14x65mm	5/16"	50
6-SH213	14G-10x22mm	5/16"	50
6-SH214	10G-16x16mm	5/16"	100
6-SH215	12G-14x20mm	5/16"	100
6-SH216	12G-14x35mm	5/16"	100
6-SH217	12G-14x45mm	5/16"	100
6-SH218	12G-14x65mm	5/16"	100
6-SH219	14G-10x50mm	3/8"	100
6-SH220	10G-16x16mm	5/16"	1000
6-SH221	10G-16x16mm	5/16"	500
6-SH222	10G-16x25mm	5/16"	500
6-SH223	12G-14x20mm	5/16"	500
6-SH224	12G-14x35mm	5/16"	1000
6-SH225	12G-14x35mm	5/16"	500
6-SH226	12G-14x45mm	5/16"	1000
6-SH227	12G-14x45mm	5/16"	500
6-SH228	14G-10x50mm	3/8"	500



SD SCREW HEX WASHERED FINE C4

EZI ORDER	SIZE	DRIVE	QTY.
6-SF212	12G-24x30mm	5/16"	50
6-SF213	14G-20x25mm	3/8"	50
6-SF214	14G-20x115mm	3/8"	10
6-SF215	10G-24x25mm	5/16"	1000
6-SF216	12G-24x30mm	5/16"	1000
6-SF217	14G-20x25mm	3/8"	500
6-SF218	14G-20x45mm	3/8"	1000
6-SF219	14G-20x65mm	3/8"	1000
6-SF220	14G-20x115mm	3/8"	250

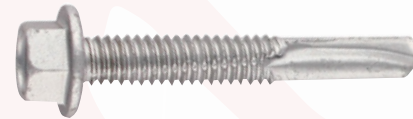

SD SCREW HEX 5 SERIES FINE C4

EZI ORDER	SIZE	DRIVE	QTY.
6-SF221	12G-24x32mm	5/16"	50
6-SF222	12G-24x50mm	5/16"	20
6-SF223	12G-24x65mm	5/16"	20
6-SF224	12G-24x85mm	5/16"	20
6-SF225	12G-24x32mm	5/16"	500
6-SF226	12G-24x50mm	5/16"	500
6-SF227	12G-24x65mm	5/16"	250
6-SF228	12G-24x85mm	5/16"	250
6-SF229	12G-20x100mm	5/16"	250
6-SF230	12G-20x150mm	5/16"	250



SD SCREW CSK HEAD WING C3

EZI ORDER	SIZE	QTY.
6-SN201	8G-18x35mm	100
6-SN202	8G-18x40mm	85
6-SN203	10G-24x30mm	50
6-SN204	10G-24x40mm	50
6-SN205	10G-24x50mm	50
6-SN206	10G-24x60mm	50
6-SN207	10G-16x40mm	50

EZI ORDER	SIZE	QTY.
6-SN208	10G-16x45mm	50
6-SN209	10G-16x55mm	50
6-SN210	10G-16x40mm	1000
6-SN211	10G-16x45mm	500
6-SN212	10G-16x55mm	500
6-SN213	10G-16x75mm	1000

STAINLESS STEEL SCREW

MORE THAN JUST LOW PRICE!



**T17 SCREW BUGLE HEAD
BATTEN 302SS**



EZI ORDER	SIZE	QTY.
6-TB301	14G-10x75mm	20
6-TB302	14G-10x100mm	20
6-TB303	14G-10x75mm	250
6-TB304	14G-10x100mm	250
6-TB305	14G-10x50mm	1000
6-TB306	14G-10x75mm	1000
6-TB307	14G-10x100mm	500



**T17 SCREW TIMBER DECKING
CSK 304SS**



EZI ORDER	SIZE	QTY.
6-TD301	10G-12x50mm	250
6-TD302	10G-12x65mm	250



**T17 DECKING SCREW TRIM
HEAD 304SS**



EZI ORDER	SIZE	QTY.
6-TD303	9G-9x53mm	100
6-TD304	9G-9x53mm	250



SD SCREW PAN COARSE 304SS



EZI ORDER	SIZE	QTY.
6-SC301	8G-18x16mm	1000
6-SC302	8G-18x19mm	1000
6-SC303	8G-18x25mm	1000



**SD SCREW TIMBER SPEEDEKZ
GP T20 DRIVE 304SS**



EZI ORDER	SIZE	QTY.
6-SZ301	10Gx50mm	250
6-SZ302	10Gx65mm	250



SD SCREW WAFER COARSE 304SS



EZI ORDER	SIZE	QTY.
6-SC304	10G-16x25mm	500



SD SCREW CSK WING SS SQ2



EZI ORDER	SIZE	QTY.
6-SN301	10G-16x50mm	1000



SD SCREW MUSH HEAD COARSE 304SS



EZI ORDER	SIZE	QTY.
6-SC305	12G-14x38mm	500



**SD SCREW SPEEDECK SQ DRIVE
316SS**



EZI ORDER	SIZE	QTY.
6-SZ650	12G-11x50mm	250
6-SZ665	12G-11x65mm	250

* Brands subject to availability

STAINLESS STEEL SCREW

MORE THAN JUST LOW PRICE!



**T17 SCREW BUGLE BATTEN
SS316**



EZI ORDER	SIZE	QTY.
6-TB601	14G-10x50mm	100
6-TB602	14G-10x75mm	100
6-TB603	14G-10x100mm	100
6-TB604	14G-10x50mm	500
6-TB605	14G-10x75mm	500
6-TB606	14G-10x100mm	500



SD SCREW HEX COARSE 304SS

EZI ORDER	SIZE	DRIVE	QTY.
6-SC306	10G-16x16mm	5/16"	500
6-SC307	12G-14x20mm	5/16"	500
6-SC308	14G-14x25mm	3/8"	500
6-SC309	14G-14x50mm	3/8"	1000
6-SC310	14G-14x75mm	3/8"	500



T17 SCREW HEX SS316

EZI ORDER	SIZE	DRIVE	QTY.
6-TH601	12G-11x25mm	5/16"	500
6-TH602	12G-11x35mm	5/16"	500
6-TH603	12G-11x50mm	5/16"	500
6-TH604	12G-11x65mm	5/16"	250
6-TH605	14G-10x100mm	3/8"	200
6-TH606	14G-10x125mm	3/8"	150
6-TH607	14G-10x150mm	3/8"	100
6-TH608	14G-10x25mm	3/8"	500
6-TH609	14G-10x50mm	3/8"	250
6-TH610	14G-10x65mm	3/8"	250
6-TH611	14G-10x75mm	3/8"	250



**SD SCREW HEX COARSE WASHERED
304SS**

EZI ORDER	SIZE	DRIVE	QTY.
6-SC311	10G-16x16mm	5/16"	500
6-SC312	12G-14x20mm	5/16"	500
6-SC313	14G-14x25mm	3/8"	500
6-SC314	14G-14x50mm	3/8"	1000
6-SC315	14G-14x75mm	3/8"	500



T17 SCREW HEX 304SS

EZI ORDER	SIZE	DRIVE	QTY.
6-TH301	14G-10x25mm	3/8"	500
6-TH302	14G-10x50mm	3/8"	1000

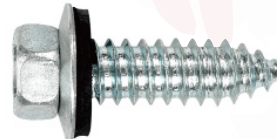

T17 SCREW HEX WASHERED 304SS

EZI ORDER	SIZE	DRIVE	QTY.
6-TW301	14G-10x25mm	3/8"	500
6-TW302	14G-10x50mm	3/8"	1000



* Brands subject to availability

ACCESSORIES

MORE THAN JUST LOW PRICE!



EPDM SEAL WASHER

EZI ORDER	SIZE	QTY.
6-EW008	8G	1000
6-EW010	10G	1000
6-EW012	12G	1000
6-EW014	14G	1000



EPDM WASHER POLYCARB

EZI ORDER	SIZE	QTY.
6-EW125	25mm	50



ALUMINIUM & EPDM BONDED WASHER

EZI ORDER	SIZE	DRIVE	QTY.
6-EW225	25mm	14G	1000



ADJUSTABLE CSK TOOL & BITS FOR SCREWS ▶

EZI ORDER	SCREW SIZE
6-AT004	14 GAUGE
6-AT812	8,10 & 12GAUGE

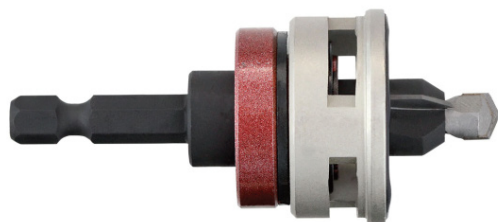
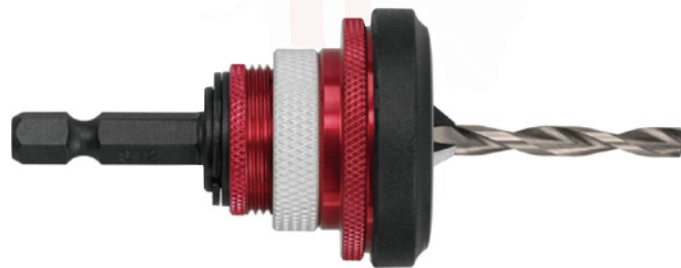

ADJUSTABLE CSK TOOL & BITS FOR 10G FIBRE CEMENT SCREWS

EZI ORDER	6-AT010
6-AT010	6-AT010



REPLACEMENT BITS

EZI ORDER	DESCRIPTION	QTY.
6-RB512	FOR TBB08G-12G	5PCS
6-RB414	FOR TBB14G	4PCS

* Brands subject to availability

ACCESSORIES

MORE THAN JUST LOW PRICE!



◀ SMARTBIT

EZI ORDER	DESCRIPTION
6-MB140	7 GAUGE & BITS (BDA140)
6-MB141	8 GAUGE & BITS (BDA141)
6-MB146	10 GAUGE & BITS (BDA146)
6-MB147	12 GAUGE & BITS (BDA147D)
6-MB150	14 GAUGE & BITS (BDA150DK)



SITE SUPPLIES



SMARTBIT 10G FIBRE CEMENT & BITS (BDA446RV)

EZI ORDER 6-MB446



SMARTBIT 14G REPLACEMENT BITS

EZI ORDER	SIZE	QTY.
6-MB144	40MM LONG (BDA170D)	4PCS
6-MB170	75MM LONG (BDA170K)	4PCS



SMARTBIT REPLACEMENT BITS 5PCE PACK

EZI ORDER	SIZE	QTY.
6-MB075	7G	5PCS
6-MB085	8G	5PCS
6-MB105	10G	5PCS
6-MB125	12G	5PCS(BDA167D)

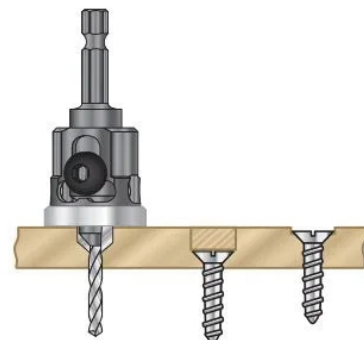

* Brands subject to availability