



USER MANUAL

Thermoelectric Cigar Cabinet

*Please Read and Keep the Manual.



Conforms to UL STD. 60335-1 and 60335-2-24
Certified to CSA Std. C22.2 # 60335-1 and 60335-2-24

ISO9001:2015
MADE IN CHINA

NEED ONE TO UPGRADE YOUR LIFE

Thank You For Choosing Our Thermoelectric Cigar Cabinet

Please make sure your items are in good condition and then confirm receipt. If you have any questions or problems, please feel free to contact us for assistance.

CONTENTS

KNOW YOUR CIGAR CABINET	-----	01-01
IMPORTANT SAFETY INSTRUCTIONS	-----	02-04
SPECIFICATIONS	-----	05-05
CONTROL PANEL	-----	05-05
BEFORE FIRST USE	-----	06-07
CLEANING & MAINTENANCE	-----	08-08
TROUBLESHOOTING	-----	09-10
WARRANTY POLICY	-----	11-11

KNOW YOUR CIGAR CABINET

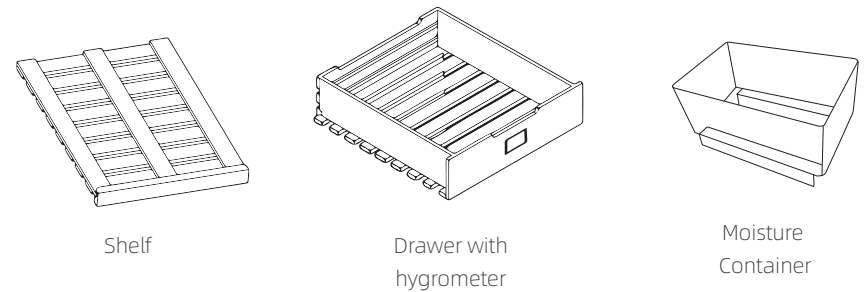
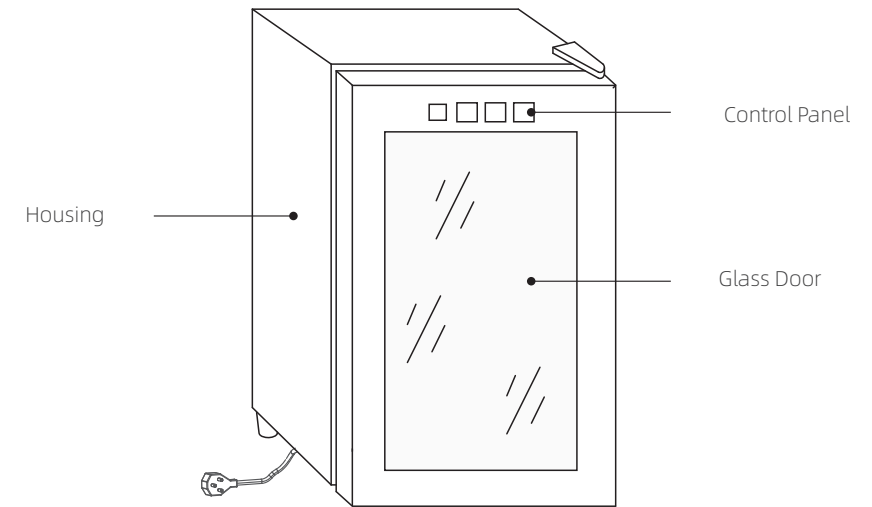

Packing List

Model No.	NO-16B	NO-23B	NO-48BT
Electronic cigar cabinet	1	1	1
Shelf	1	2	3
Drawer with hygrometer	1	1	1
Moisture Container	1	1	1

IMPORTANT SAFETY INSTRUCTIONS

Please read all Danger instructions and warnings in the user manual before using this equipment.

Danger

- 1 Do not touch the power supply with wet hands.



- 2 If there is damage to the plug, power cord or product, please stop using the cigar cabinet.
If the SUPPLY CORD is damaged, it must be replaced by the manufacturer, its service agent or similarly qualified persons in order to avoid a hazard.

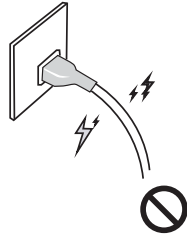

- 3 For your safety, the cigar cabinet should be properly grounded and to reduce the possibility of electric shock, the unit is equipped with a Type B plug.
Never remove the ground wire from the plug.

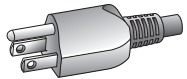

- 4 Before connecting the power supply, check that the voltage indicated on the appliance corresponds to the local mains voltage.

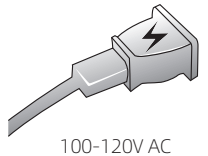

- 5 Do not connect this device to an external timer switch or to a separate remote control system to avoid dangerous situations.

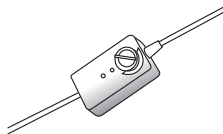

BATTERY WARNING: KEEP OUT OF REACH OF CHILDREN

If you think batteries might have been swallowed or placed inside any part of the body, seek immediate medical attention.

- 6 Children should be supervised to ensure that they do not play with the appliance.

WARNING: Risk of child entrapment. Before you throw away your old refrigerator or freezer:

- * Take off the doors.
- * Leave the shelves in place so that children may not easily climb inside.



- 7 Do not use flammable liquids to clean electrical components, as they may cause fire or explosion. Do not store or use gasoline or any other appliances near any other flammable gases and liquids.

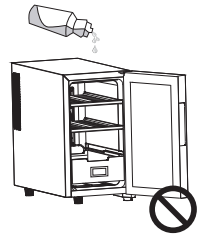

Warning

This appliance is not intended for use by persons (including children) with reduced physical, sensory or mental capabilities, or lack of experience and knowledge, unless they have been given supervision or instruction concerning use of the appliance by a person responsible for their safety.

1 It is recommended that cigar cabinets be placed away from heat sources (ovens, gas stoves, etc.)



2 Please don't use the cigar cabinets outdoors.



3 Do not fill your cigar cabinet to the brim, leave room for air to circulate inside your cigar cabinet.



4 Do not use for purposes other than preserving cigars. Do not store perishable food in the cigar cooler, as the internal temperature will not be low enough to prevent spoilage.

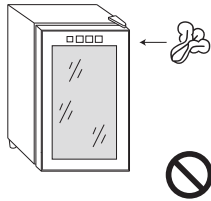

5 If the cigar cabinet is broken, please contact customer service to determine the repair item and reissue the relevant parts.



6 It is recommended to clean the fan and dust trap every 3 months to ensure better cooling effect.

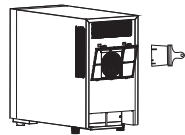

7 Do not place the product against a wall or other furniture or appliances. Leave at least 4 inches of space on the back, right side and above the product.

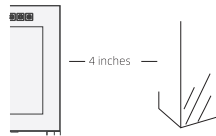

8 Avoid direct sunlight on the cigar cabinet. This appliance is for household use only. Any other use will void the warranty.



SPECIFICATIONS

Model No.	NO-16B	NO-23B	NO-48BT
Rated Voltage	110-120V AC 60Hz		
Power Consumption	60W±6W		
Storage Capacity	100 Cigars	150 Cigars	300 Cigars
Temperature Range	54°F-74°F		

CONTROL PANEL

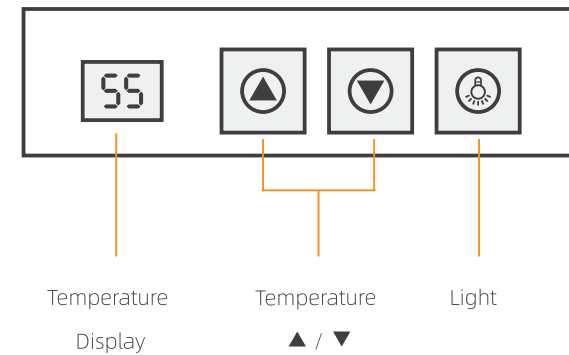

*LED display generally shows the internal temperature of the cigar cabinet.

*You can set the temperature by touching Δ / ∇ . The preset temperature will flash on the display for 5 seconds, and then the LED display will show the cabinet internal temperature again.

BEFORE FIRST USE

1. Remove all packaging materials.

2. Place the cigar cabinet in the right place:

- (1) The cigar cabinet is a stand-alone unit and should not be installed in a cabinet or other built-in enclosure.
- (2) To ensure good heat exchange, leave 2 inches on each side of the unit and 4 inches on the back and top.
- (3) Place the cigar cabinet on a level surface sturdy enough to support the unit when it is fully loaded. To make the cigar cabinet stable, adjust the front feet located at the bottom.
- (4) Place the cigar cabinet away from direct sunlight and heat sources such as stoves, heaters or radiators. Direct sunlight may affect the acrylic coating of the machine. A nearby heat source can increase power consumption. Extreme light or hot ambient temperatures can have a bad effect on the performance of the cigar cabinet.
- (5) The cigar cabinet should be upright for 2 hours before connecting to the power supply.

Note:

This cigar cabinet is for home use only and is not suitable for placement in garages, basements or outdoor areas. It is recommended that it be installed in an ambient temperature between 64°F and 78°F. Too high or too low an ambient temperature may affect cigar cabinet performance and too cold or too hot may cause excessive temperature fluctuations inside the unit affecting cigar preservation. In addition, the temperature can be slightly affected by whether the cigar cabinet is lit or not.

3. Factory odor removal

Clean the inside of your cigar cabinet by using a mild detergent and warm water. Don't get the wood wet. Leave the door open and let it dry completely. If it still smells like "plastic", put a dish of baking soda in the fridge or put newspaper in the fridge overnight. After completing the above, let the unit run all day to complete the venting process.

4. Set Up the Drawer

- (1) Install hygrometer batteries.

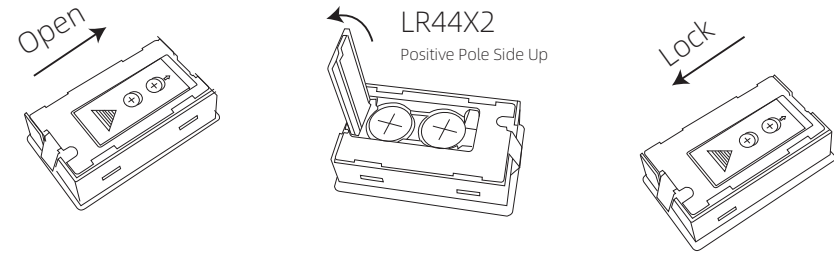

*Button Battery Model: LR44

*Battery power can be used for about 9 months. The hygrometer should be replaced with a new battery when it is not working.

*The battery needs to be removed when not in use for a long time.

- (2) The drawers and shelves of this cigar cabinet are designed to sit flush with the front edge of the cigar cabinet. This will allow air to circulate freely within the unit. When inserting the drawers and shelves, avoid pushing the drawers and shelves directly against the back wall of the cabinet.
- (3) Clean the interior surfaces of the unit with warm water and a soft cloth, but do not get the wood wet.

5. Seasoning your cigar cabinet

It is best to season your wooden shelves and drawers before storing your cigars so that the wood is at an ideal relative humidity (RH) and does not absorb humidity from your cigars.

- (1) Add distilled water to the container, or add a sponge that has been soaked with distilled water. Make sure that the water does not come in direct contact with the wood, otherwise it may damage it.
- (2) Allow the moisture container or other humidifying device to sit in the cooler until its relative humidity is 5% higher than your preferred level. This process may take up to 3 days, but it is the best way to ensure that your cigars remain in the best condition possible.
- (3) Once cooled to this temperature, you can start adding cigars. To monitor the RH and make sure it stays at the level you want, you can add a few contents at a time. If it drops too much, you can use the same seasoning method to pull it up.

Note:

It is recommended that you do not open the door unnecessarily throughout the process, as this will allow moisture to escape and delay the process.

CLEANING & MAINTENANCE

Cleaning steps:

1. Unplug the cigar cabinet from the power supply and remove the contents and shelves stored inside
2. Clean the inside of the unit with a solution consisting of warm water and baking soda solution (2 tablespoons of baking soda to 1 quart of water).
3. Remove the water storage tank at the bottom of the unit and rinse with water.
4. To clean the exterior of the unit, use mild detergent and warm water.

Note:

Please clean the dust separator at intervals of 3 months.

Notes on moving cigar cabinets:

1. Remove everything stored in the machine and secure any loose parts with tape.
2. Adjust the flattening feet to the base to avoid damage.
3. Make sure the cooler is in an upright position when moving.

CIGAR STORAGE GUIDANCE

1. The ideal temperature for storing cigars is between 64°F-74°F Humidity (RH) are 55-65% RH.
2. In order to properly maintain the RH of the Cigar cooler, you will need to include a method of increasing the humidity. For your convenience, a moisture container is included. To use a container containing moisture to increase the humidity of the unit, simply fill the container with distilled water or a wet sponge and place it back into the unit.

Please note: Water should be replaced when the desired humidity level is reached and replenished when used again.

3. It is recommended to keep the cigars in their original boxes and packaging for as long as possible. Keep unpackaged cigars separately in a cooler to avoid unwanted flavor mixing.
4. Check cigars regularly for signs of tobacco beetles and mold, and take precautions if necessary.
5. Stored in the proper manner, cigars can be stored for 5-10 years, and even longer under ideal conditions.

TROUBLESHOOTING

Problem	Possible Causes	Solution
The cooler does not work.	The cooler power is not plugged in.	Check whether the power supply is properly connected.
	The fuse of cooler has blown.	Make sure the power is disconnected and contact a professional to repair it.
The cooler is not cold enough.	Environmental temperature is too high.	The cooler should be placed in a well-ventilated area of the house and away from direct sunlight.
	The door may be opened too frequently.	Reduce the time and frequency of opening doors.
	The door is not closed completely.	Make sure the door is properly closed after you pick up the cigar each time.
	The door seal is out of place.	Check the door seal and try to adjust it to the correct position.
	There's not enough room for heat dissipation.	Make sure there is at least 2 inches from each side and 4 inches at the back and above the cooler.

The cooler vibrates while operating.	The cooler is not placed in stable.	Adjust and fix the four feet of the device.
Noise from the cooler.	The cooler is not placed in stable.	Adjust and fix the four feet of the device.
	Noise from the cooling fan.	Check the cooling fan to ensure that there is no debris and looseness.
The light does not work.	There may be a problem with the display board.	Contact the Customer Service.
The hygrometer is not working.	The button battery of the hygrometer is low.	Purchase new LR44 button cell batteries and replace the old ones.



Please scan the QR code on the left to view our guide video to assist in solving the problem, if the above list fails to solve your problem. If the problem still cannot be solved, please contact us and our customer service to provide you with other solutions.

Our team is committed to providing quality products. However, after a long logistic transportation, we cannot ensure that the products are free from abnormalities such as looseness. Therefore, please check whether the package is intact and whether the product parts are damaged or missing at the first time after you receive it.

If there are any problems, please reject the package or contact our customer service, we will assist you in making a claim to the logistics provider.

WARRANTY POLICY

This humidifier is covered by the manufacturer's limited warranty. For a period of 12 months from the date of purchase, if any part of this product is found to be defective due to material, workmanship or shipping, it will be repaired or replaced at no cost to the original purchaser.

From the 2nd year of purchase, if any part of this product is found to be defective due to material or workmanship, it will be repaired at the manufacturer's discretion and at no cost to the original purchaser, except that shipping costs will be paid by the original purchaser.

The manufacturer does not offer an extended warranty option at this time, but if you experience a problem with the product after the 2nd year of purchase, try contacting us and we will contact the manufacturer for you and do our best to provide you with a solution based on the condition of the product.

DISCLAIMER OF WARRANTY

The warranty is not available if the damage is caused by:

1. Cigar cooler is artificially damaged during use. Improper power supply, such as too low or too high voltage, faulty household wiring or insufficient fuses.
2. Accidents, modifications, misuse or abuse of apparatus, such as the use of unapproved accessories, inadequate room air circulation or abnormal operating conditions (extreme temperatures).
3. For commercial or industrial applications fire, flood, theft, war, riot, hostile or natural disasters such as hurricanes, floods, etc.
4. Violent use or damage due to external influences.
5. Partial or total disassembly of the cigar cabinet section.
6. Excessive wear and tear by the user.

For more questions or help needed, please contact our online service to get the fastest reply and best solution, thank you and good luck for all :)

