

LED Glass Wall Pack Series

Wattages: 50W, 70W, 100W / Tunable Wattages: 30W/50W/60W/70W

LED Glass Wall Pack series can be widely used in indoor or outdoor lighting (wet location). Ideal for mechanical or electronic processing workshops, storage warehouses, steel mills, gas stations, toll booth, waiting rooms, the platforms of railway station, indoor stadiums.



WATT/CCT
FIELD-ADJUSTABLE

FEATURES

- Lumileds LED, high luminous efficiency and long working life.
- High efficiency LED Driver, the wide range input voltage AC120-277V/AC 277-480V.
- Excellent optics design, greatly improve the light utilization and evenness.
- Motion sensor control available (Optional)
- 1-10V Dimming.

Die-cast aluminum cooling design, high quality and better cooling for LED Tj < 85°C.



SPECIFICATION				
WATTAGE	50W	70W	100W	30W/50W/60W/70W
LUMEN	6600 lm	9380 lm	13500 lm	4368 / 6821 / 8047 / 9032 lm
EFFICACY	132 lm/W	134 lm/W	135 lm/W	up to 129 lm/W
CCT	4000K, 5000K			3000K/4000K/5000K
CRI	70			
INPUT VOLTAGE	120-277V			
POWER FACTOR	0.95			
DRIVER EFFICACY	90%			
LIGHT ANGLE	87° X 118°			
LIFE SPAN	75,000 hrs			
WORKING TEMPERATURE	-22°F ~ 113°F			
STORAGE TEMPERATURE	-40°F ~ 176°F			
OUTDOOR RATING	IP65 Rating			
CABLE	Input Connect, No cable			
WARRANTY	5 year limited			

LED Glass Wall Pack Series

Wattages: 50W, 70W, 100W / Tunable Wattages: 30W/50W/60W/70W

DIMENSION

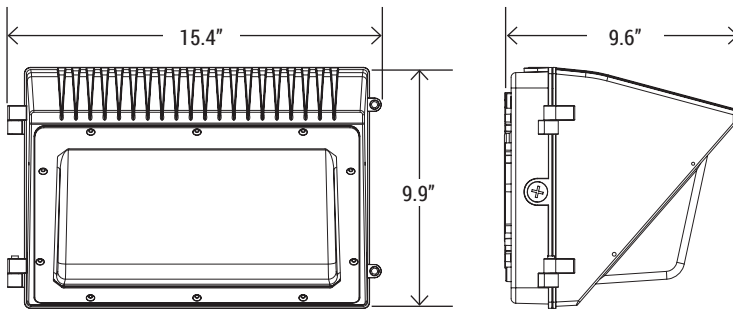

WATTAGE	50W	70W	100W	3567W
NT. WEIGHT	9.92 lbs	10.4 lbs	10.8 lbs	10.4 lbs
BOX DIM.	17.13" x 10.43" x 10.5"			17.72" x 10.43" x 10.5"

CONTROLS (SOLD SEPARATELY)



P (Photocell)



WATT/CCT
FIELD-ADJUSTABLE

EMERGENCY BACK-UP (SOLD SEPARATELY)



BLD-CM20N-480800-8W
8W Emergency Backup Battery
LED Driver

BLD-CM20N-480800-15W
15W Emergency Backup Battery
LED Driver

BLD-CM20N-480800-20W
20W Emergency Backup Battery
LED Driver

ORDERING INFORMATION

EXAMPLE:

WSD-GWP-07W-27-50K-P

WSD	GWP	07W	27	50K	D	P
COMPANY	PRODUCT	WATTAGE	VOLTAGE	CCT	FINISH	CONTROL
WSD LED INC	GWP Glass Wall Pack	05W - (50W) 07W - (70W) 10W - (100W) 3567W - (30W/50W/60W/70W)	27 (AC120-277V)	40K - (4000K) 50K - (5000K) 345K - (3000K/4000K/5000K)	D - (Dark Bronze) W - (White) B - (Black) S - (Silver)	P - (Photocell)

LED Glass Wall Pack Series

Wattages: 50W, 70W, 100W / Tunable Wattages: 30W/50W/60W/70W

PHOTOMETRICS

For complete IES files, please visit our website.

WSD-GWP-05W27-50K

LUMINOUS INTENSITY DISTRIBUTION DIAGRAM

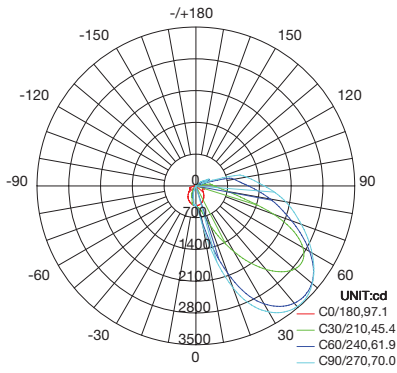

AVERAGE BEAM ANGLE(50%):68.6 DEG

C0 PLANE ISOLUX DIAGRAM (UNIT:lx)

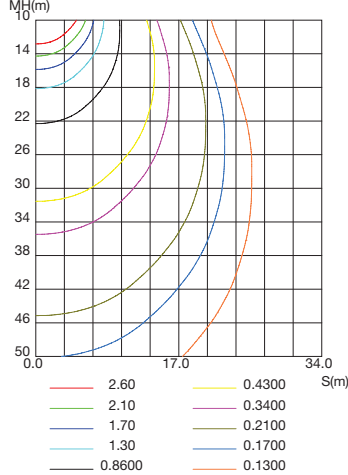

ISOLUX DIAGRAM

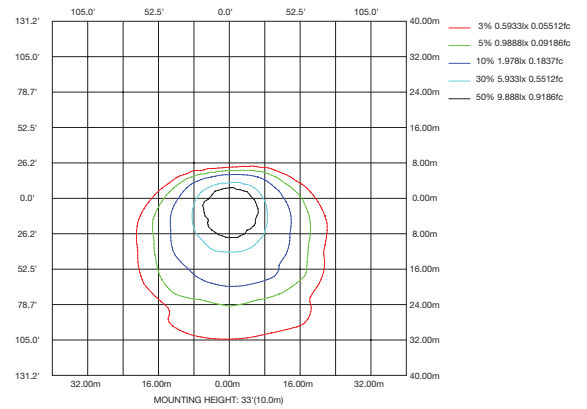

WSD-GWP-07W27-50K

LUMINOUS INTENSITY DISTRIBUTION DIAGRAM

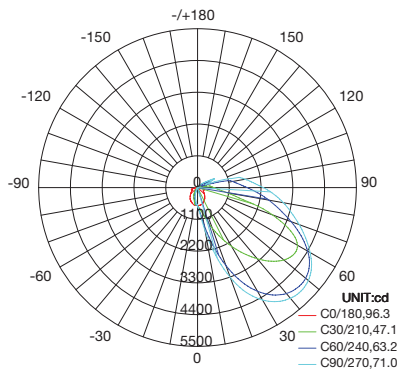

AVERAGE BEAM ANGLE(50%):69.4 DEG

C0 PLANE ISOLUX DIAGRAM (UNIT:lx)

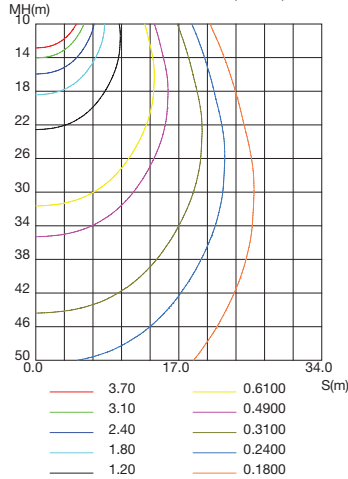

ISOLUX DIAGRAM

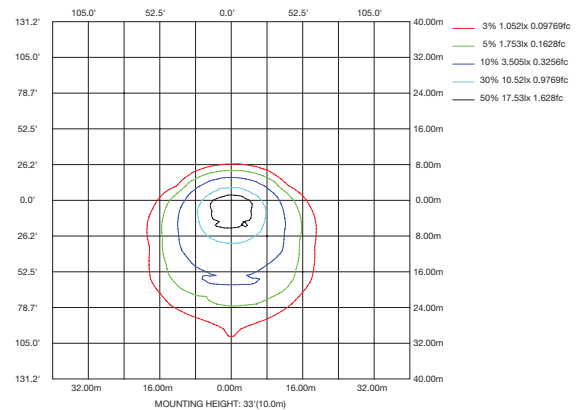

WSD-GWP-10W27-50K

LUMINOUS INTENSITY DISTRIBUTION DIAGRAM

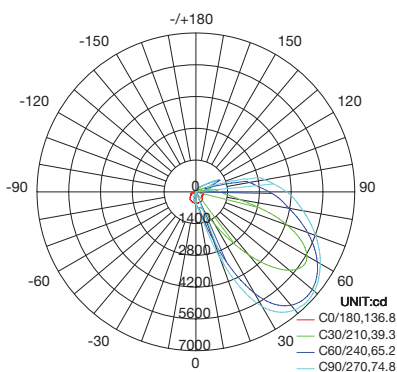

AVERAGE BEAM ANGLE(50%):79.0 DEG

C0 PLANE ISOLUX DIAGRAM (UNIT:lx)

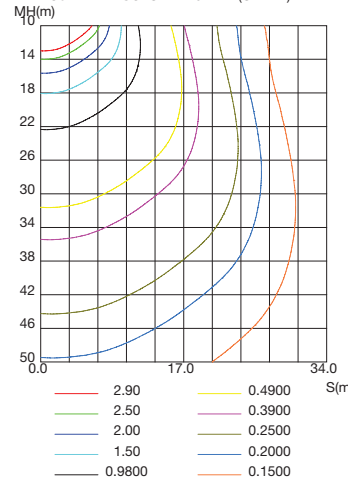

ISOLUX DIAGRAM

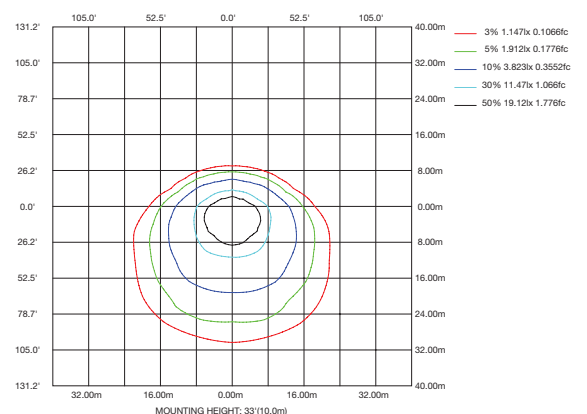

LED Semi Cut-Off Wall Pack Series

Wattages: 50W, 70W, 100W / Tunable Wattages: 30W/50W/60W/70W

PHOTOMETRICS

For complete IES files, please visit our website.

WSD-GWP-3567W27-50K (30W@5000K)

LUMINOUS INTENSITY DISTRIBUTION DIAGRAM

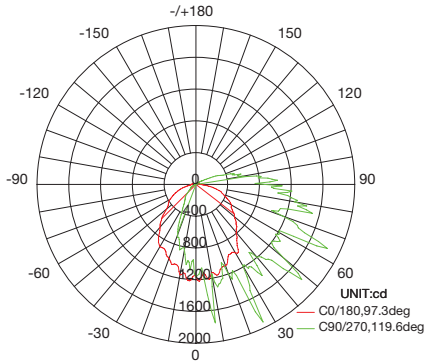

AVERAGE BEAM ANGLE(50%):108.5 DEG

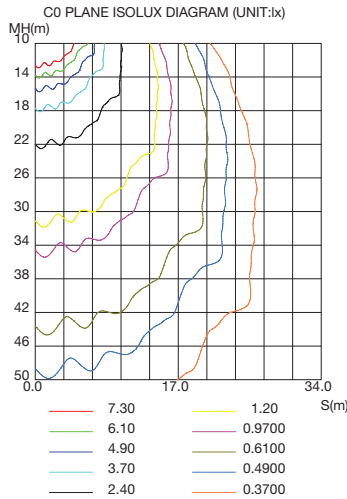

ISOLUX DIAGRAM

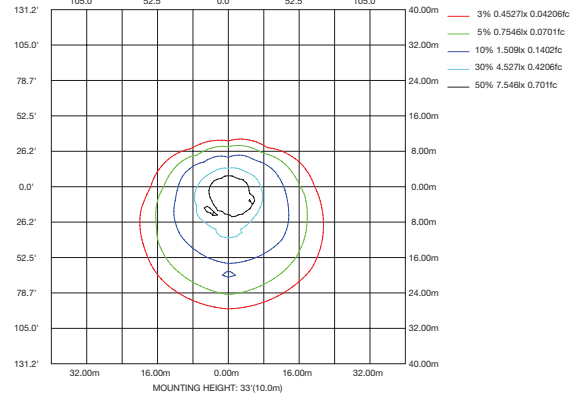

WSD-GWP-3567W27-50K (50W@5000K)

LUMINOUS INTENSITY DISTRIBUTION DIAGRAM

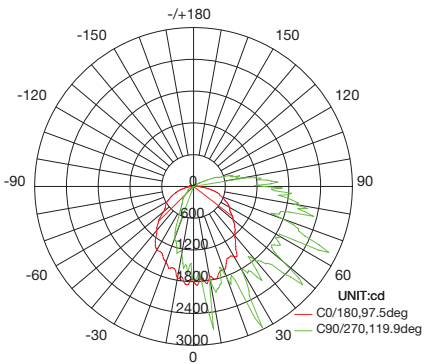

AVERAGE BEAM ANGLE(50%):108.7 DEG

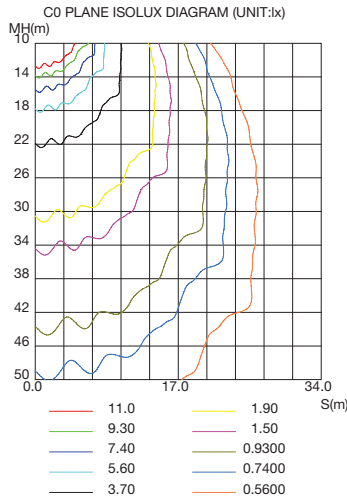

ISOLUX DIAGRAM

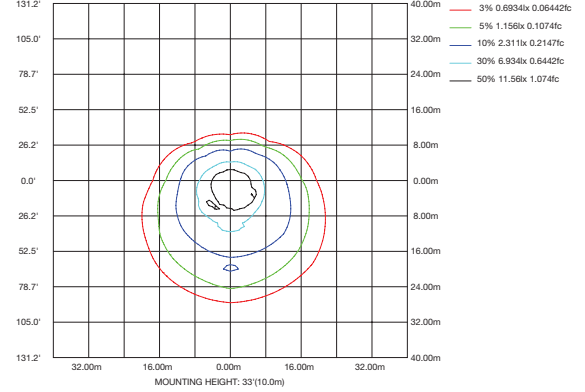

WSD-GWP-3567W27-50K (60W@5000K)

LUMINOUS INTENSITY DISTRIBUTION DIAGRAM

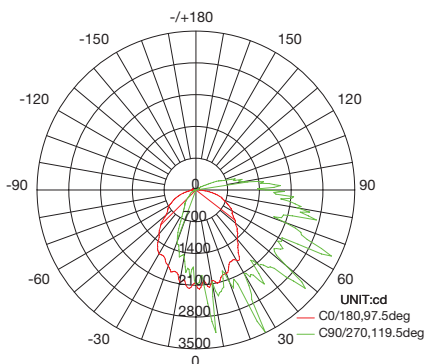

AVERAGE BEAM ANGLE(50%):108.5 DEG

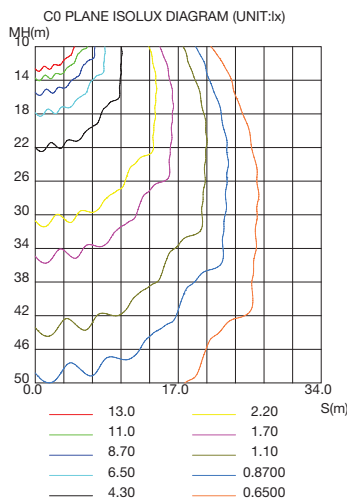

ISOLUX DIAGRAM

