

LED 电源规格书
LED Power Supply Specification

CURTOMER /客户:	
PRODUCT /产品类型:	LED Power Supply/LED驱动电源
MODEL NO. /产品型号:	WP-HHA-100U Series
PART NO./物料编号:	

DESIGNED BY / 拟制	CHECKED BY / 审核	APPROVED BY / 批准
Date / 日期:	Date / 日期:	Date / 日期:

CUSTOMER APPROVED SIGNATURES 客户承认签核		
Testing Engineer /测试工程师	CHECKED BY / 审核	APPROVED BY / 批准
Date / 日期:	Date / 日期:	Date / 日期:
For confirmation, please sign and return this specification to us. 客户确认签字, 盖章后请回传一份承认书给我司.		

1. Electrical / 电气特性

1.1 Input characteristics / 输入特性

Classification / 类别	Subject of entry/项目	
Input characteristics 输入特性	Rated input voltage/额定输入电压	120-277Vac
	Range input voltage/电源输入电压范围	108-305Vac
	Input current/输入电流	<1.1A
	Input frequency/输入频率	50/60Hz
	Input frequency range/输入频率范围	47-63Hz
	Turn on delay time/启动时间	≤500ms
	No-load power consumption/空载功耗	≤1.5W
	Stand-by power consumption/待机功耗	≤1W
	Inrush current /浪涌电流	<60A
	Power factor(@70%Load to Full load)/功率因数	≥0.9
	THD(@70%Load to Full load)/总谐波失真	≤15%

1.2 Output Characteristics / 输出特性

Constant Current Mode/定电流模式(CV测试)

Model No./型号	Output Voltage range/ 输出电压范围 (V)	Rated Current 额定电流 (mA)	OVP/ 过压保 护(V)	Output power(Rat ed) / 输出 功率(额 定)(W)	Efficiency/效率(%)		Output ripple(peak to peak) 输出纹波 (峰-峰 值) ①
					@120Vac	@277Vac	
WP-HHA-100U0521500	35-52	1500	63	78	≥88	≥89	<4V
WP-HHA-100U0521550	35-52	1550	63	80.6	≥88	≥89	<4V
WP-HHA-100U0521600	35-52	1600	63	83.2	≥88	≥89	<4V
WP-HHA-100U0521650	35-52	1650	63	85.8	≥88	≥89	<4V
WP-HHA-100U0521700	35-52	1700	63	88.4	≥88	≥89	<4V
WP-HHA-100U0521750	35-52	1750	63	91	≥88	≥89	<4V
WP-HHA-100U0521800	35-52	1800	63	93.6	≥88	≥89	<4V
WP-HHA-100U0521850	35-52	1850	63	96.2	≥88	≥89	<4V
WP-HHA-100U0501900	35-50	1900	63	95	≥88	≥89	<4V
WP-HHA-100U0482000	35-48	2000	63	96	≥88	≥89	<4V
WP-HHA-100U0462100	35-46	2100	63	96.6	≥88	≥89	<4V
WP-HHA-100U0442200	27-44	2200	63	96.8	≥87	≥89	<4V
WP-HHA-100U0422300	27-42	2300	50	96.6	≥87	≥89	<4V
WP-HHA-100U0402400	27-40	2400	50	96	≥87	≥89	<4V
WP-HHA-100U0382500	27-38	2500	50	95	≥87	≥89	<4V
WP-HHA-100U0382550	27-38	2550	50	96.9	≥87	≥89	<4V

Note/注释①

Ripple noise measurement method/纹波噪声测量方法

10% of nominal output voltage (whichever is greater), measured at 20MHz bandwidth with 0.1uF ceramic capacitor in parallel with 10uF electrolytic capacitor connected at the end of the output connector.

额定输出电压的 10%，测试条件：输出端由 0.1uF 瓷片电容和 10uF 电解电容并联，20M 带宽范围测试。

1.3 protection Characteristics / 保护特性

1.3.1 Short circuit protection / 短路保护

Hiccup/short happened between the output terminals and shall not result in fire and any damage. The power no output, output will auto recover upon removal of over load.

当输出端短路时，产品输入功率降低或无输出且不会损伤，当短路情况解除后，产品将会自动恢复正常。

1.3.2 Other protection / 其他保护

Rely on input fusing.

电流保险丝。

1.3.3 Inrush current Waveform& Maximum loading of automatic circuit breakers / 浪涌电流波形与断路器最大负荷

Automatic circuit breaker type 断路器型号	C10	C13	C16	C20	B10	B13	B16	B20	Inrush Current 浪涌电流	
	Installation Φ 导线直径	1.5mm ²	1.5mm ²	2.5mm ²	2.5mm ²	1.5mm ²	1.5mm ²	2.5mm ²	2.5mm ²	I _{max}
WP-HHA-100U	11	15	19	25	7	9	11	15	41.6A	65uS

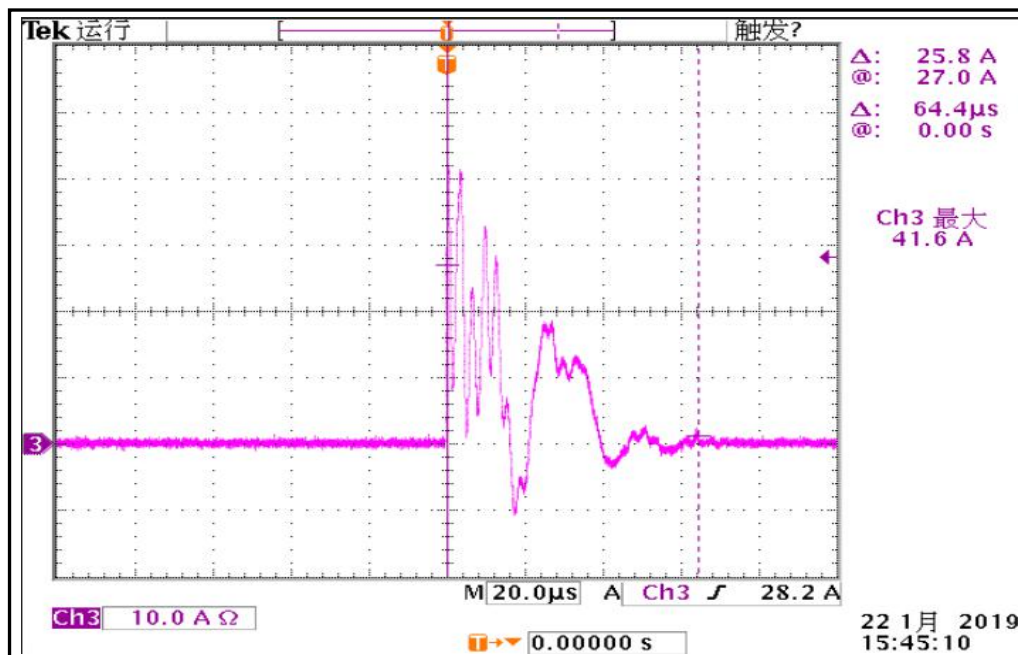

Notice/备注:

Calculation uses typical values from ABB series S200 as a reference.

以 ABB S200 系列断路器的典型值作为参考计算。

Actual values may differ due to used circuit breaker types and installation environment

由于使用的断路器型号以及安装环境影响，实际值可能存在差异。

Shenzhen Wei Peng Shiji Technology Co., Ltd.

1.3.4 Derating curve/冗余曲线图

	-40°C	-25°C	0°C	25°C	45°C	60°C
120V	100%	100%	100%	100%	100%	100%
277V	100%	100%	100%	100%	100%	100%

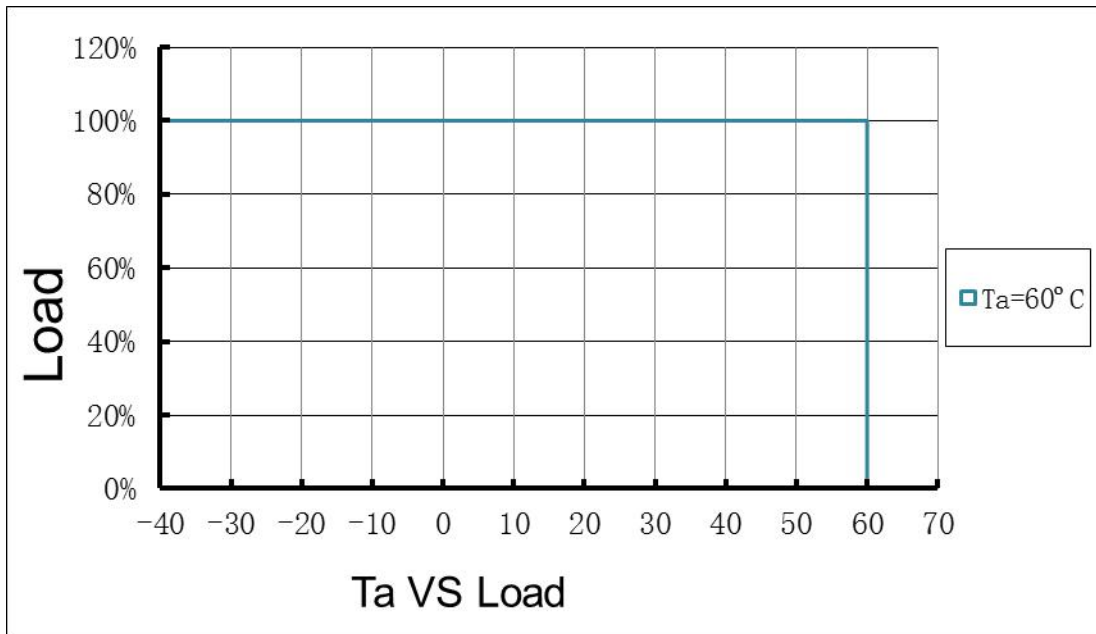

1.3.5 Static characteristics/静态特征

108Vac	120V	220V	240V	277V	305V
100%	100%	100%	100%	100%	100%

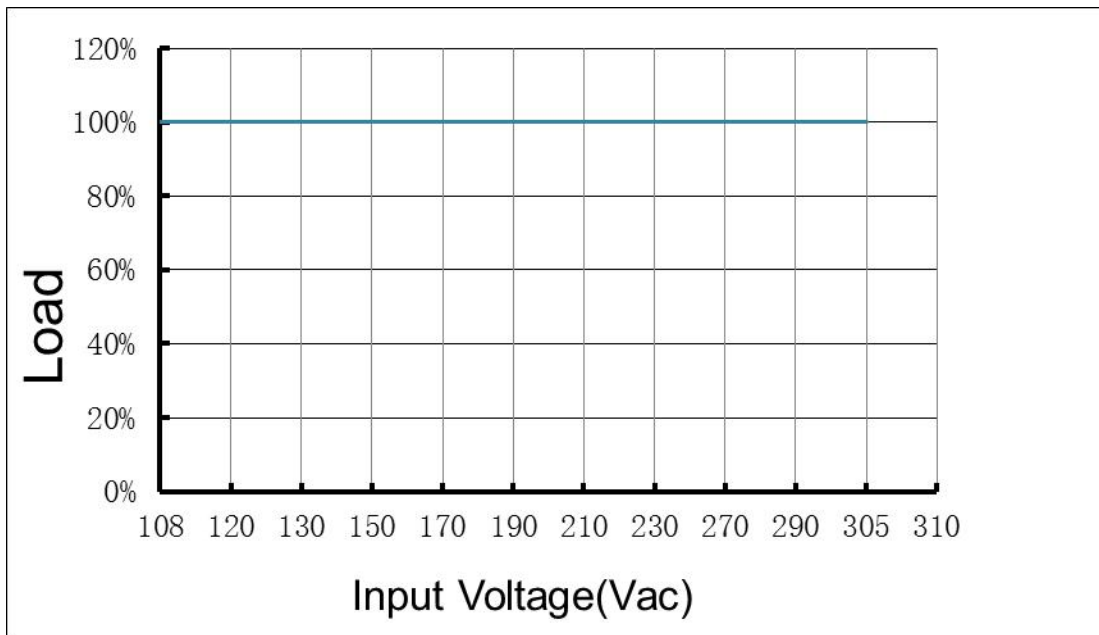

1.3.6 Efficiency VS Load Curve/效率-负载曲线

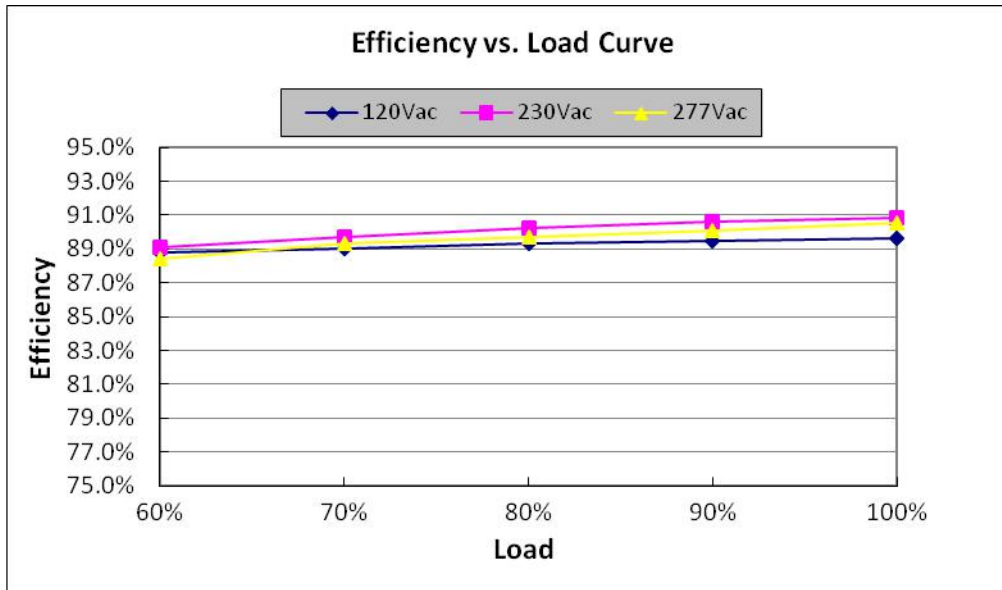

1.3.7 Power Factor vs. Load Curve/功率因素-负载曲线

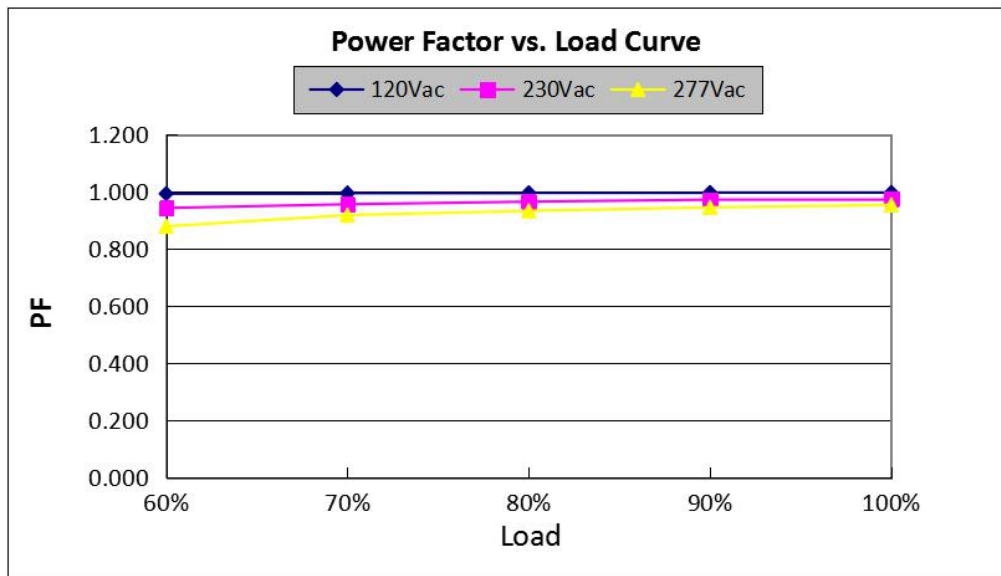

Shenzhen Wei Peng Shiji Technology Co., Ltd.

1.3.8 THDI vs. Load Curve/总谐波失真-负载曲线

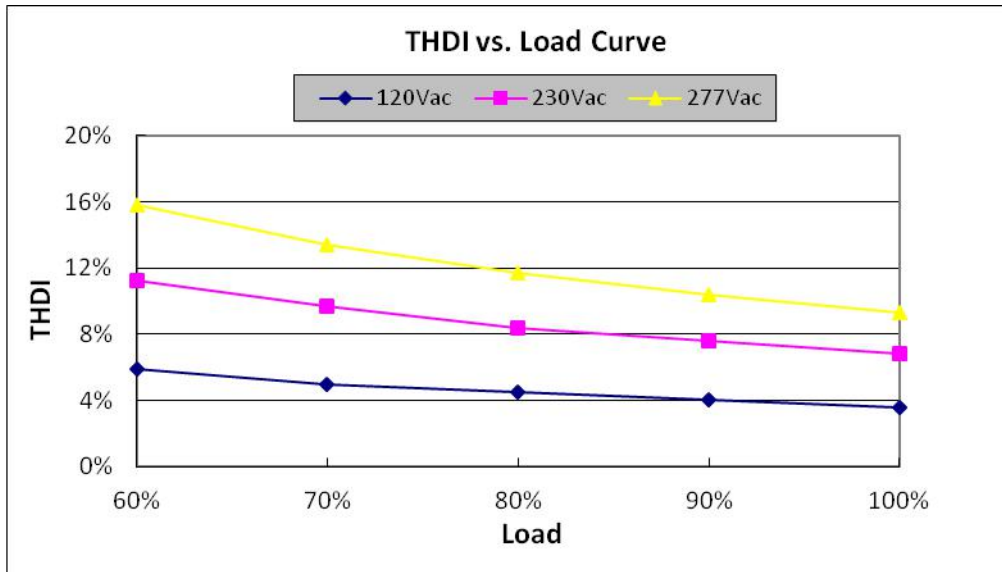

1.4 Environmental/环境系数

Classification/类别	Subject of entry/项目	
Safety&EMC 安规和电磁兼容	Safety Standards / 安规标准	UL8750/CAN/CSA-C22.2 NO. 250.13
	EMC / 电磁兼容	EN55015 and FCC part 15 class B.
Hi-Pot / 耐压	I/P-O/P/输入-输出	1.6KVac,5mA,60S;
	I/P-FG/输入-地	1.5KVac,5mA,60S;
	O/P-FG/输出-地	1.5KVac,5mA,60S;
lightning surge 雷击浪涌	ICE61000-4-5	L-N :2KV L&N-PE:4KV
Insulation Resistance 绝缘阻抗	I/P-O/P; O/P-FG; I/P-FG	100Mohm/500Vdc
Leakage current 漏电流	277Vac input / 277V交流输入漏电流	<1.6mA
Environmental 环境系数	MTBF / 平均间隔故障时间	200,000 hours at 25°C ambient temperature
	Operation temperature / 工作温度	-40 °C to 60 °C
	Humidity / 湿度	10% to 90%
	Storage temperature / 储存温度	-40°C to 85°C
	Protection Class/防护等级	IP65
	Environment rating/环保标准	RoHS
	Case Size/外壳尺寸(L*W*H)mm	L*W*H: 240*43.2*30mm

Shenzhen Wei Peng Shiji Technology Co., Ltd.

2. Product life reference diagram/产品寿命参考示图

Warranty(保质期) : please refer to document WELEDPOWER LIMITED WARRANTY 2017/请参考伟鹏世纪科技有限公司2017年保修协议

Case Temperature 外壳温度 (tc)	50°C	60°C	65°C	70°C	75°C	80°C	85°C	90°C
Lifespan/寿命 (KHours)	120	120	120	85.7	60.6	42.8	30.3	21.4

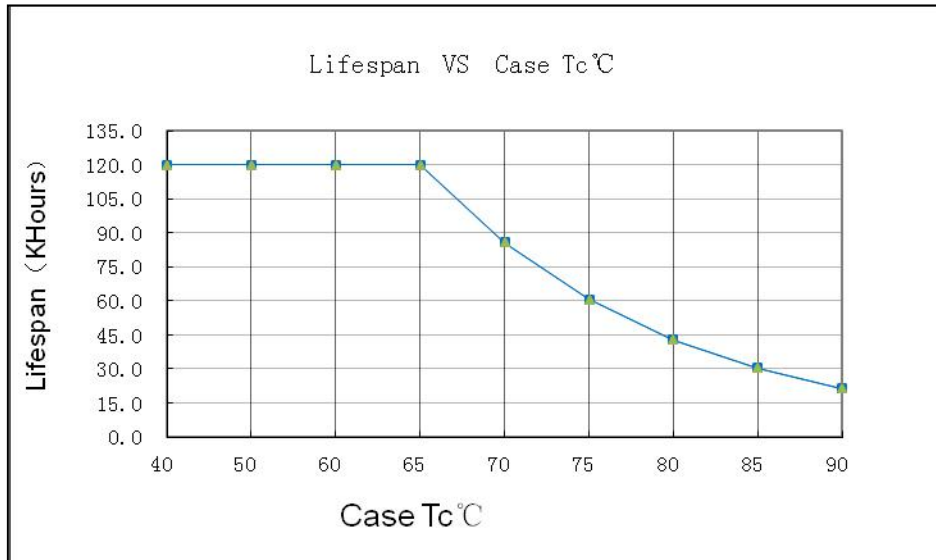

3. Dimming function/调光功能

1-10V Dimming/1-10V 调光; 5-100% dimming scope/调光范围 5-100%

Dimming Voltage 调光电压 (V)	1	2	3	4	5	6	7	8	9	10	OPEN
Percentage of rated current 额定电流百分比	5%	20%	33%	46%	58%	71%	84%	97%	100%	100%	95%-105%

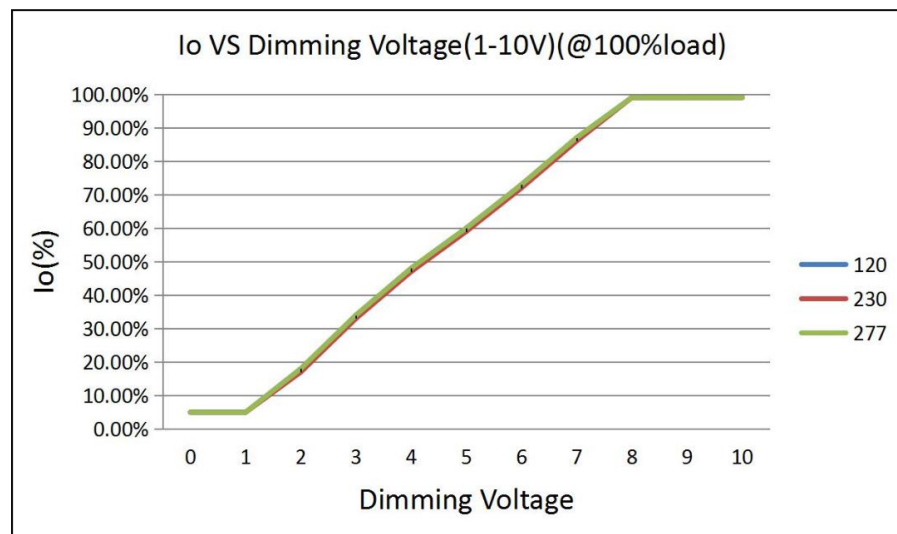

4. Enclosure/外观示意图

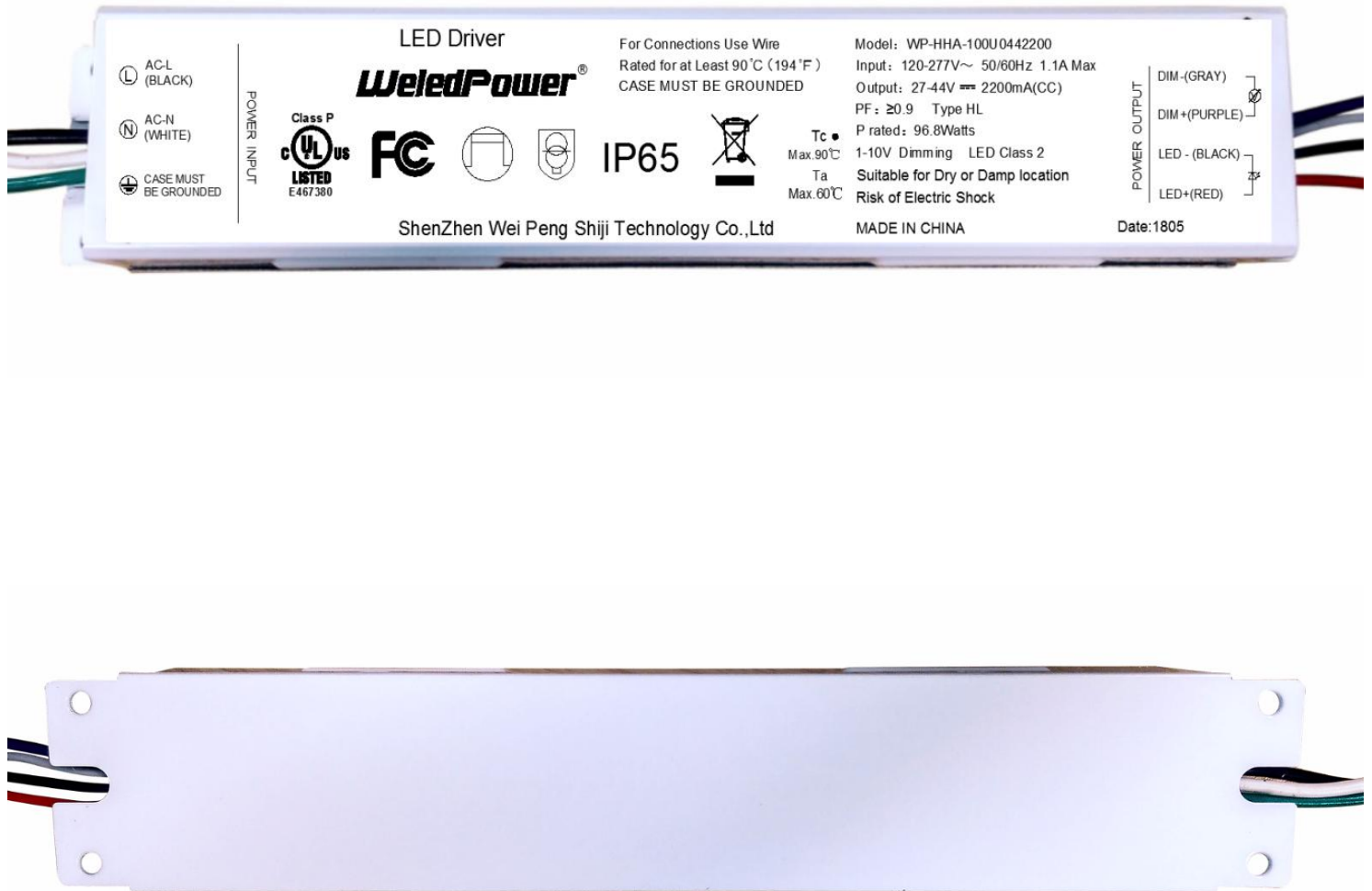

5. Mounting hole size/安装孔尺寸

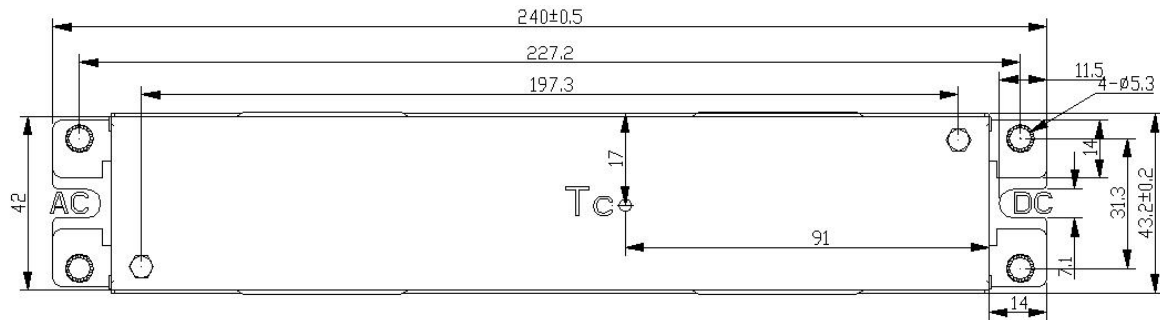
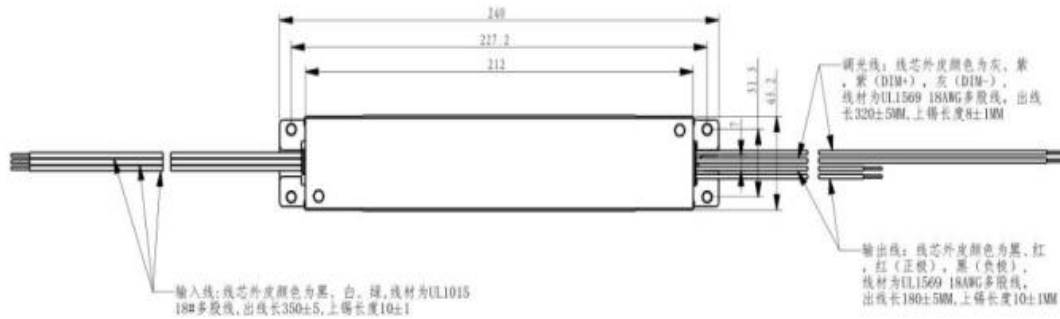
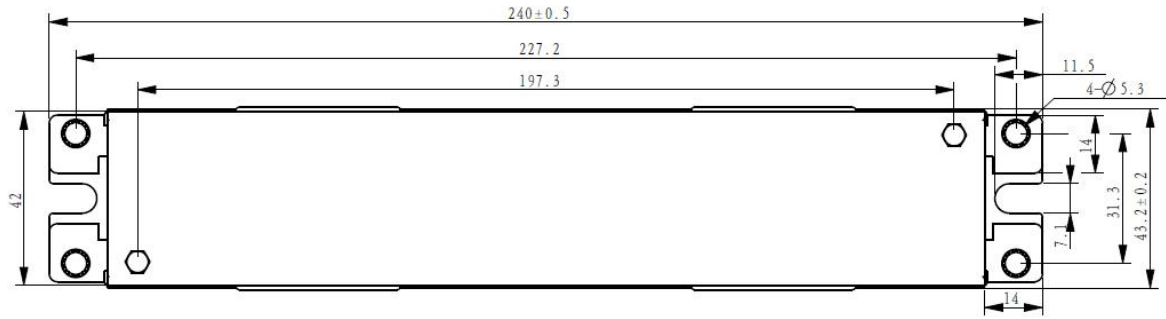

6. Label / 铭牌

<ul style="list-style-type: none"> Ⓛ AC-L (BLACK) Ⓝ AC-N (WHITE) Ⓧ CASE MUST BE GROUNDED 	<p>POWER INPUT</p>	<p>LED Driver</p> <p>WeledPower®</p>		<p>For Connections Use Wire Rated for at Least 90°C (194°F) CASE MUST BE GROUNDED</p>	<p>Model: WP-HHA-100U0442200 Input: 120-277V~ 50/60Hz 1.1A Max Output: 27-44V = 220mA(CC) PF: ≥0.9 Type HL P rated: 96.8Watts 1-10V Dimming LED Class 2 Suitable for Dry or Damp location Risk of Electric Shock</p>	<p>POWER OUTPUT</p>	<ul style="list-style-type: none"> DIM-(GRAY) DIM+(PURPLE) LED-(BLACK) LED+(RED)
		<p>Class P UL US LISTED E467380</p> <p>FC</p> <p>IP65</p> <p>ShenZhen Wei Peng Shiji Technology Co.,Ltd</p>	<p>Tc Max.90°C</p> <p>Ta Max.60°C</p> <p>MADE IN CHINA</p>				

Shenzhen Wei Peng Shiji Technology Co., Ltd.

7. Packing/包装

Net Weight/净重: 0.56 kgs/0.56千克

QTY/数量: 32pcs/32个

Carton Dimension/包装尺寸: 420x320x190mm

Net Weight/Gross Weight 净重/毛重: 17.9kgs/19kgs

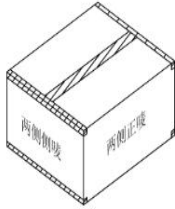
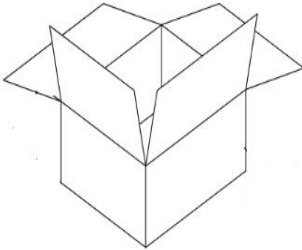

两侧侧吸

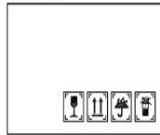

两侧正吸

P/N:	LOT/NO:
QTY:	PCS DATE:
N. W:	KG G. W: KG
SIZE:	

History/历史

NO. 序号	DATE 日期	REVISION 版本号	REMARK 备注	Changer 修改人
1.	2019.03.25	V0.90	初拟定/ First drafting	吴杨兵/ Yangbing Wu