

# Selectable Compact LED Linear High Bay

Wattage: 100W,115W, 135W ; 155W, 185W, 200W ; 200W, 230W, 270W; 270W, 340W, 400W

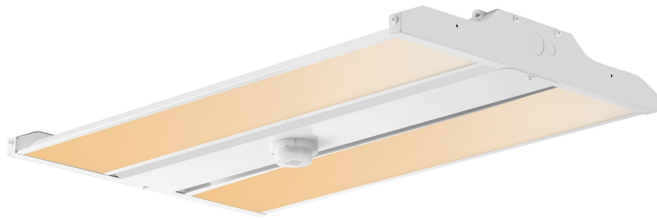

The Linear High Bay with its all-in-one, lightweight and slim with multiple mounting situations available put it at the top of the list for any high ceiling area where super bright light is needed. The LED Linear High bay Light Series can be widely used for indoor excellent for warehouse, industry building, factories, fitness center, and many other applications.

Lighting controls meet design lights consortium (DLC) networked lighting control system technical requirements, LLLC, Energy Monitoring and High End Trim function.

**WATT/CCT  
SELECTABLE**



**MESH RANGE** 60ft node-to-node and 500ft node-to-Gateway (Commissioning)

## FEATURES

- Optical design, greatly improved the light utilization an evenness.
- High efficiency LED Driver, voltage AC120-277 .
- Rugged galvanized rolled iron plate housing, better cooling, light quality, LED Tj < 85°C.
- 0-10V dimming.
- 12Vdc auxiliary dimming
- Field install plug and play Bi-Level Sensor.



**Bluetooth®**  
(Option)

Easy field-install motion sensor

## SPECIFICATION

TYPE	LHB1.4F100/115/135W27-45K-G2	LHB1.9F155/185/200W27-45K-G2	LHB2.6F200/230/270W27-45K-G2	LHB3.7F270/340/400W27-45K-G2
WATTAGE	100W/115W/135W	155W/185W/200W	200W/230W/270W	270W/340W/400W
LUMEN	15923 lm/17709lm/19917lm	23444 lm/26623lm/28094lm	31180 lm/34782lm/39773lm	41668 lm/50558lm/56154lm
EFFICACY	>155 lm/W	>150 lm/W	>150 lm/W	>150 lm/W
CCT	4000K/5000K			
CRI	>80			
FACTORY SETTINGS	135W & 4000K	200W & 4000K	270W & 4000K	400W & 4000K
INPUT VOLTAGE	AC120-277V			
LIGHT ANGLE	90X95°			
POWER FACTOR	0.98			
DRIVER EFFICACY	90%			
LIFE SPAN	over 75,000 hrs			
WORKING TEMPERATURE	-4°F ~ 122°F			
PROTECTION LEVEL	Damp location			
CABLE	Input connect, No cable			
WARRANTY	5 year limited			

# Selectable Compact LED Linear High Bay

Wattage: 100W,115W, 135W ; 155W, 185W, 200W ; 200W, 230W, 270W; 270W, 340W, 400W

## DIMENSION

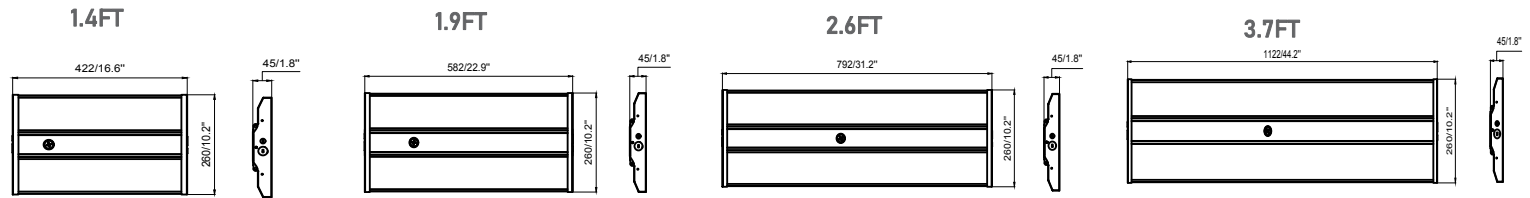

<b>WATTAGE</b>	100W,115W,135W
<b>GR. WEIGHT</b>	5.7 lbs
<b>BOX DIM.</b>	17.3"x10.6"x2"(1pcs/CTN) 17.8"x8.7"x11"(4pcs/CTN)

<b>WATTAGE</b>	155W,185W,200W
<b>GR. WEIGHT</b>	7.3 lbs
<b>BOX DIM.</b>	23.6"x10.6"x2"(1pcs/CTN) 24.1"x8.7"x11"(4pcs/CTN)

<b>WATTAGE</b>	200W,230W,270W
<b>GR. WEIGHT</b>	10.4 lbs
<b>BOX DIM.</b>	31.9"x10.6"x2"(1pcs/CTN) 32.4"x8.7"x11"(4pcs/CTN)

<b>WATTAGE</b>	270W,340W,400W
<b>GR. WEIGHT</b>	13.7 lbs
<b>BOX DIM.</b>	44.9"x10.6"x2"(1pcs/CTN) 45.9"x11.1"x4.3"(2pcs/CTN)

## CONTROL (SOLD SEPARATELY)

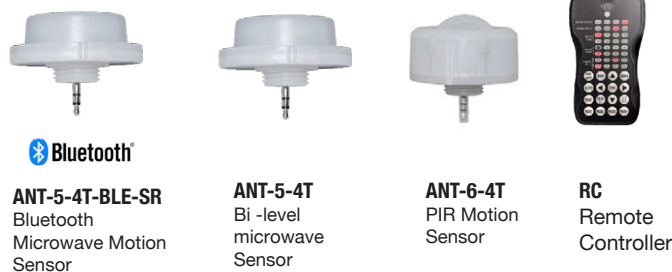

## CONTROL MODULE

**WATT/CCT**  
FIELD-ADJUSTABLE

Simply select desired CCT and Wattage before installation



## LIGHT DISTRIBUTION CHANGEABLE ( OPTION )

General and Aisle light distribution changeable by quickly replacing lens.

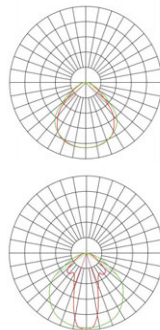

### Conventional luminous Angle:

- PMMA LENS: 90X95°-1.4ft
- PMMA LENS: 90X95°-1.9ft
- PMMA LENS: 90X95°-2.6ft
- PMMA LENS: 90X95°-3.7ft

### Extremely narrow luminous Angle:

- PMMA LENS: 40X110°-1.4ft MODEL:WSD-1.4FTA40110-PMMA
- PMMA LENS: 40X110°-1.9ft MODEL:WSD-1.9FTA40110-PMMA
- PMMA LENS: 40X110°-2.6ft MODEL:WSD-2.6FTA40110-PMMA
- PMMA LENS: 40X110°-3.7ft MODEL:WSD-3.7FTA40110-PMMA

## ORDERING INFORMATION

EXAMPLE: **LHB1.4F100/115/135W27-45K-E[Blank,M,]-G2**

LHB	1.4F	100W	27	45K	E	G2
PRODUCT	SIZE	WATTAGE	VOLTAGE	CCT	CONTROL	UPDATE
LHB (Linear Hig Bay)	1.4F (1.4-foot) 1.9F (1.9-foot) 2.6F (2.6-foot) 3.7F (3.7-foot)	100W - (100W) 115W - (115W) 135W - (135W) 155W - (155W) 185W - (185W) 200W - (200W) 230W - (230W) 270W - (270W) 340W - (340W) 400W - (400W)	27 (AC120-277V)	45K - (4000K/5000K)	M Motion Sensor	Second generation product

# Selectable Compact LED Linear High Bay

Wattage: 100W,115W, 135W ; 155W, 185W, 200W ; 200W, 230W, 270W; 270W, 340W, 400W

## WIRE GUARD (SOLD SEPARATELY)

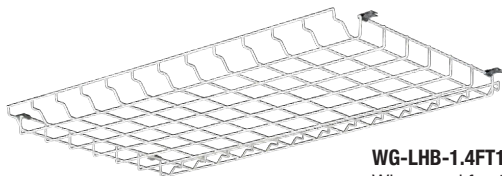

**WG-LHB-1.4FT100W-115W-135W**  
Wire guard for 100W/115W/135W

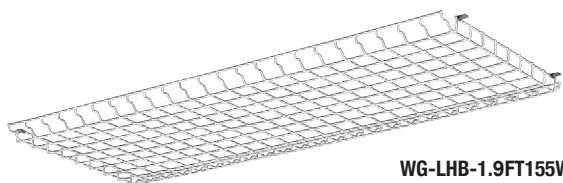
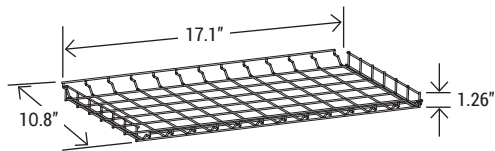

**WG-LHB-1.9FT155W-185W-200W**  
Wire guard for 155W/185W/200W

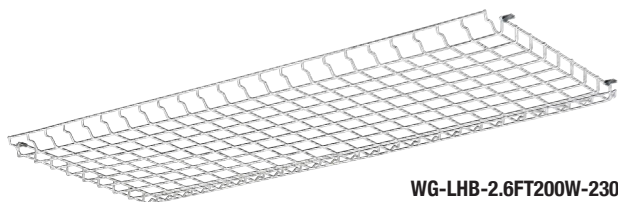
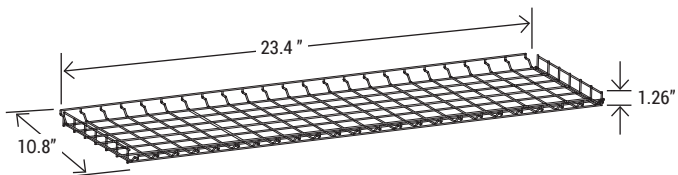

**WG-LHB-2.6FT200W-230W-270W**  
Wire guard for 200W/230W/270W

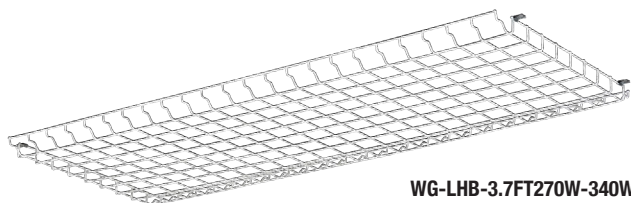
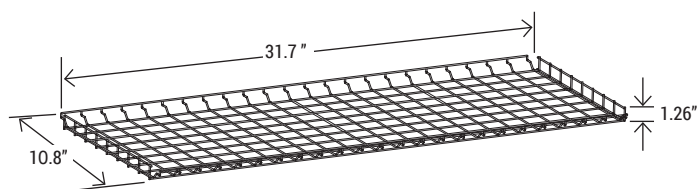

**WG-LHB-3.7FT270W-340W-400W**  
Wire guard for 270W/340W/400W

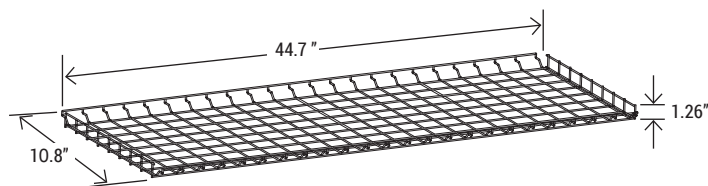

## INCLUDED IN THE PACKAGE (STANDARD)

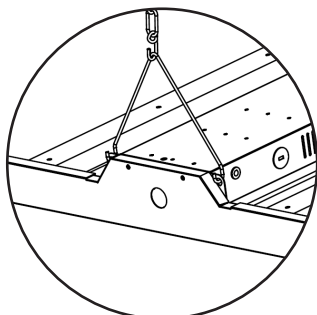

**WSD-LHB-HOOK-CHAIN**  
41.34 inch CHAINS and HOOK

## PENDANT MOUNTING BOX (SOLD SEPARATELY)

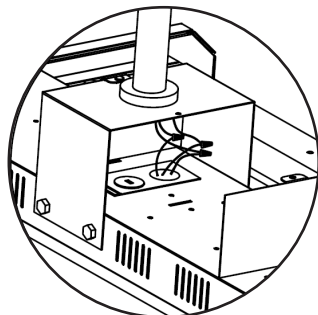

**WSD-LHB-PMK-LID**  
Pendant Mounting Box

## SURFACE MOUNT KIT (SOLD SEPARATELY)

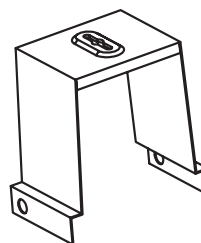

**WSD-LHB-SMK**  
Surface mount kit

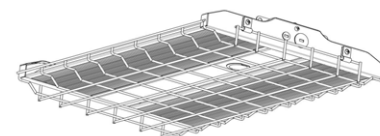

Wire guards

# Selectable Compact LED Linear High Bay

Wattage: 100W,115W, 135W ; 155W, 185W, 200W ; 200W, 230W, 270W; 270W, 340W, 400W



## ANT-5-4T-BLE-SR

Plug and Play Network BLE Nodes and Sensor

The Bluetooth Lighting Control provides automated individual and group control of light fixtures using on sensors and Bluetooth mesh technology. The ANT-5-4T-BLE-SR mounted in an Commercial lighting fixture and provides multi-level control solution based on motion and or daylight harvesting contribution.

### FEATURES

- Lighting controls meet design lights consortium (DLC) networked lighting control system technical requirements.
- Quick connect and adjust different sensor angle.
- Easy commissioning with Mobile App (Available in IOS).
- Bluetooth network with Saas working by computer
- Individual addressability and/or grouping.
- Time clock scheduling for individual lights, groups or scenes.
- Multi-level dimming: manual ON/OFF automatic ON/OFF, and automatic partial ON/OFF, daylight harvesting control capability.

### DIMENSION

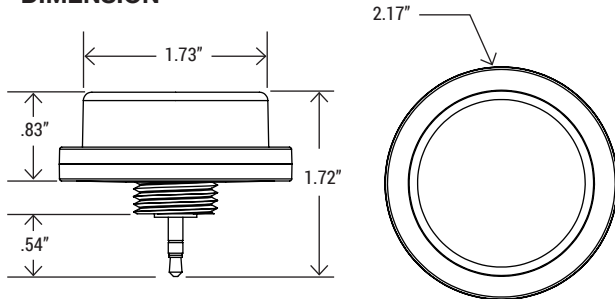

### COVERAGE

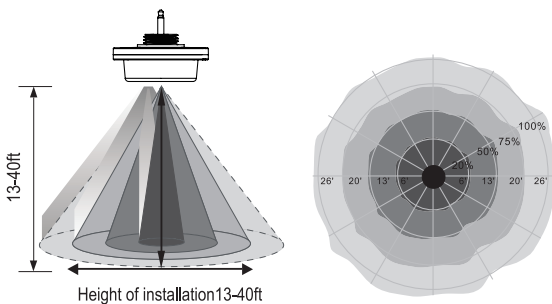

### SPECIFICATION

NETWORK BLE MESH	Yes
DAYLIGHT HARVESTING	Yes
MICROWAVE MOTION SENSOR	Yes
DETECTION MODE	Occupancy/Vancancy/Bi-level in 1 Unit
OPERATING VOLTAGE	12-24V DC
OPERATING CURRENT	>50mA
SINKING CURRENT	max. 25mA
CONTROL OUTPUT	0-10V
RADIO FREQUENCY	2.4GHz ± 75MHz
WIRELESS STANDARD	BLE 5.0 MESH
PROGRAMMING	Silvair iOS App ( IOS )
CYBERSECURITY	UL
ENCRYPTION	AES 128-bit
MESH RANGE	60ft node-to-node and 500ft node-to-device (Commissioning)
SAFETY	cULus Listed
FCC	FCC
OPERATING TEMP.	-20°C - +60°C
IP RATING	IP65
WARRANTY	5 year limited

### MICROWAVE SENSOR FEATURES

DAYLIGHT HARVESTING	On/Off
MOTION SENSING	On/Off
FIRST TIME DELAY	1-59 mins/infinite
SECOND TIME DELAY	0-59 mins/infinite
DIM LEVEL	0-100%
MOUNTING HEIGHT	13-40ft
DETECTION RANGE	up to 52ft diameter
DETECTION: HORIZONTAL	360°
DETECTION: VERTICAL	90°

### COMMISSIONING

Silvair iOS App makes it easy to pair devices, create groups, set scenes/schedules, customize dimming levels, and adjust high trim based on application needs.

Please scan and download the app.



iOS

Operation Instruction:  
[https://youtu.be/8KWPK7z\\_Tng](https://youtu.be/8KWPK7z_Tng)

# Selectable Compact LED Linear High Bay

Wattage: 100W,115W, 135W ; 155W, 185W, 200W ; 200W, 230W, 270W; 270W, 340W, 400W

## GateWay Remote Control

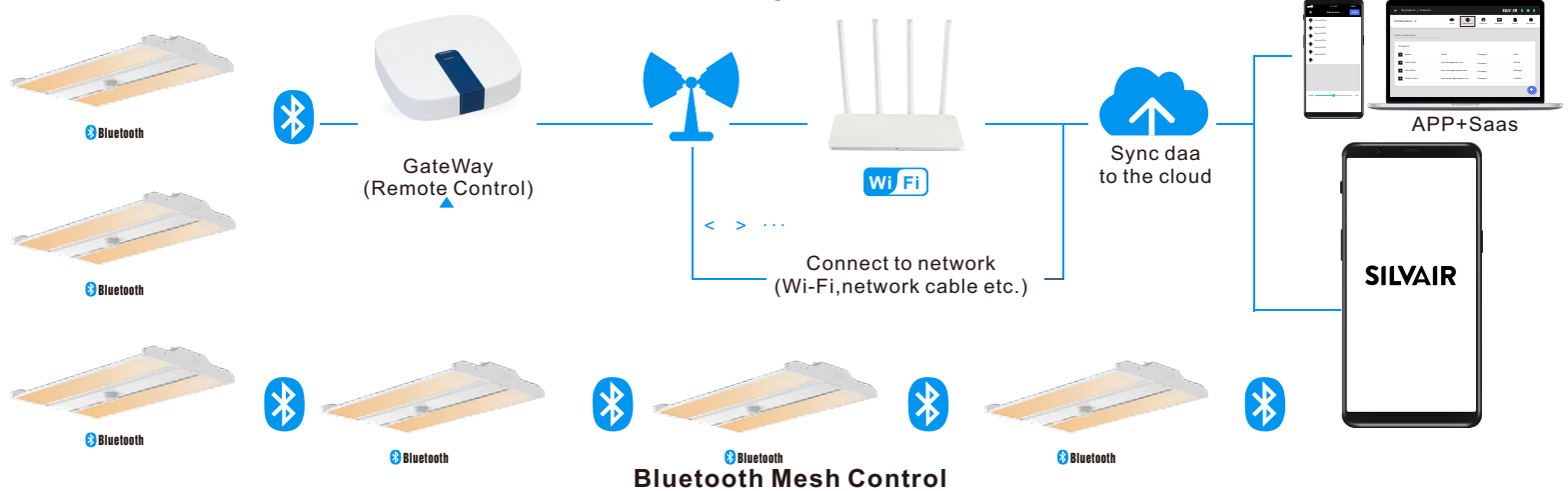

### Functions:

- The Silvair Gateway enables the following functions in the Silvair web app:
  - Scheduling (available by default)
    - Scheduling changes in scenes and lighting control scenarios (for example occupancy sensing, daylight harvesting) for specific times or days.
  - Energy and occupancy monitoring (additional paid service)
    - Visualizing energy use and occupancy via the Silvair web app.
    - Downloading energy and occupancy via the Silvair web app and cloud-based API.
  - Remote monitoring and control (additional paid service)
    - Low-latency monitoring of the status of devices in the network via API.
    - Low-latency control of devices in the network via API.
  - System diagnostics
    - Monitoring of the status of Bluetooth mesh networks.
    - Remote troubleshooting of networking issues.

### Features:

- Future-proof Linux operating system.
- Simple commissioning using the Silvair Commissioning tools.
- Automatic connection to the Silvair cloud.
- Secure provisioning with secure IDs and encrypted keys.
- High level of hardware and software security (secure boot and encrypted file system can only be accessed with the management platform).
- Automatic security updates.
- Prompt releases of OS updates and fixes to vulnerabilities.
- Low-latency transfer of network, luminaire, and sensor status data to the Silvair cloud.
- Schedule caching.
- Automatic remote firmware updates.
- Display of gateway and network performance metrics (requires the Silvair web app).

## INDUSTRIAL GATEWAY

### SGW-101

#### Smart Engineering Gateway

The Silvair Gateway connects Bluetooth mesh networks that have been commissioned using the Silvair Commissioning tools to the Silvair cloud. This allows the scheduling of events and delivery of services based on the data generated by these networks.

### SPECIFICATION

<b>POWER SUPPLY</b>	4.5–5.5 V DC, 2 A Power over Ethernet 36–57 V DC (IEEE 802.3af)
<b>OPERATING SYSTEM</b>	Ubuntu Core
<b>PROCESSOR</b>	i.MX6ULL (Y2), 32-bit ARM 800 MHz
<b>MEMORY</b>	512 MB DDR3L SDRAM 8GB eMMC
<b>COMMUNICATION PROTOCOLS</b>	Bluetooth mesh (2.4 GHz Bluetooth Low Energy) Wi-Fi 802.11a/b/g/n/ac (2.4/5 GHz) 4G LTE Cat 1 with 2G/3G (only for Cascade-500-W and Cascade-500-X gateways)
<b>PORTS</b>	1 x RJ45 10/100 Ethernet 1 x USB 2.0 Type-A 2 x external dipole antenna, 5 dBi (only for Cascade-500-W and Cascade-500-X gateways)
<b>REQUIRED AMBIENT TEMPERATURE</b>	0°C to 60°C 32°F to 140°F
<b>ENCLOSURE DIMENSIONS</b>	127 mm x 127 mm x 30 mm (5 inch x 5 inch x 1.2 inch)
<b>MOUNTING POSITION</b>	Wall or surface mounted. As close to the geometrical center of the lighting network as possible, but as far as possible from potential sources of interference.
<b>SECURITY</b>	Secure boot with encrypted operating system Secure communication with the Silvair Cloud over Internet (TLS) Secure communication with devices over qualified Bluetooth mesh



# Selectable Compact LED Linear High Bay

Wattage: 100W,115W, 135W ; 155W, 185W, 200W ; 200W, 230W, 270W; 270W, 340W, 400W

## PHOTOMETRICS

For complete IES files, please visit our website.

### LHB1.4F100/115/135W27-45K-G2

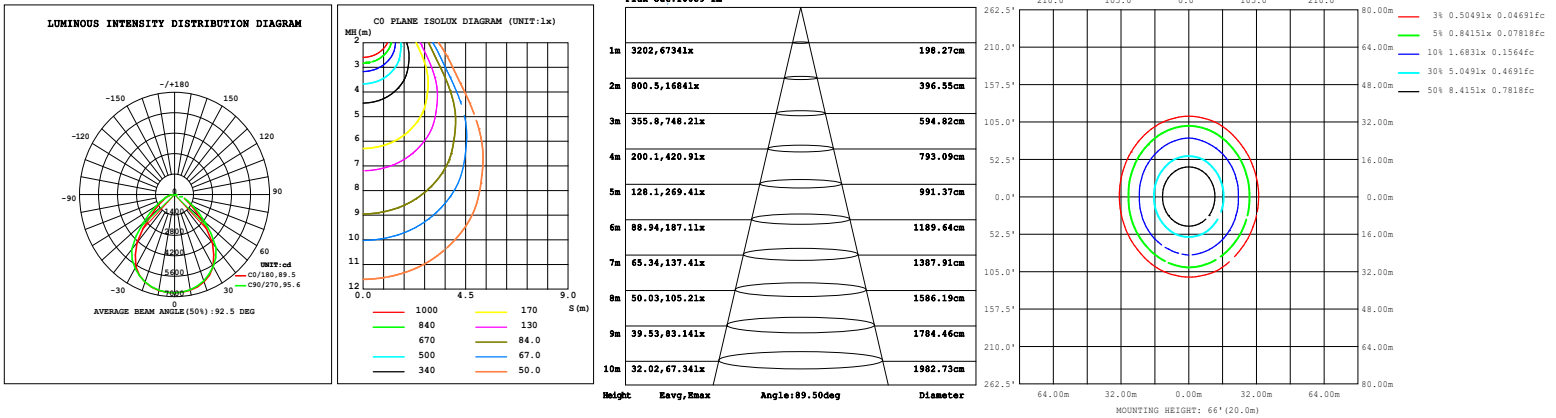

### LHB1.9F155/185/200W27-45K-G2

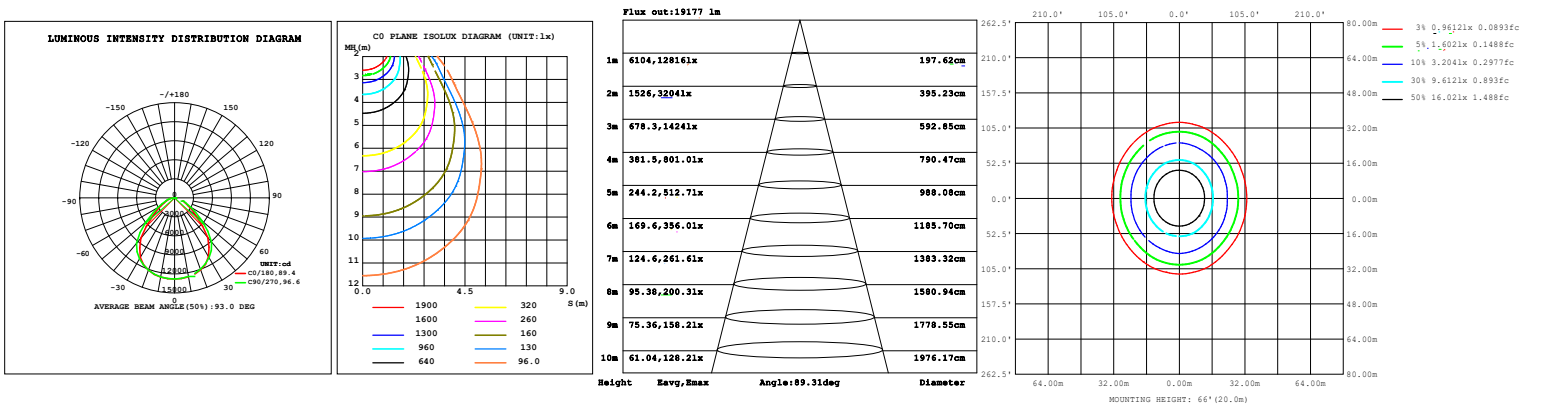

### LHB2.6F200/230/270W27-45K-G2

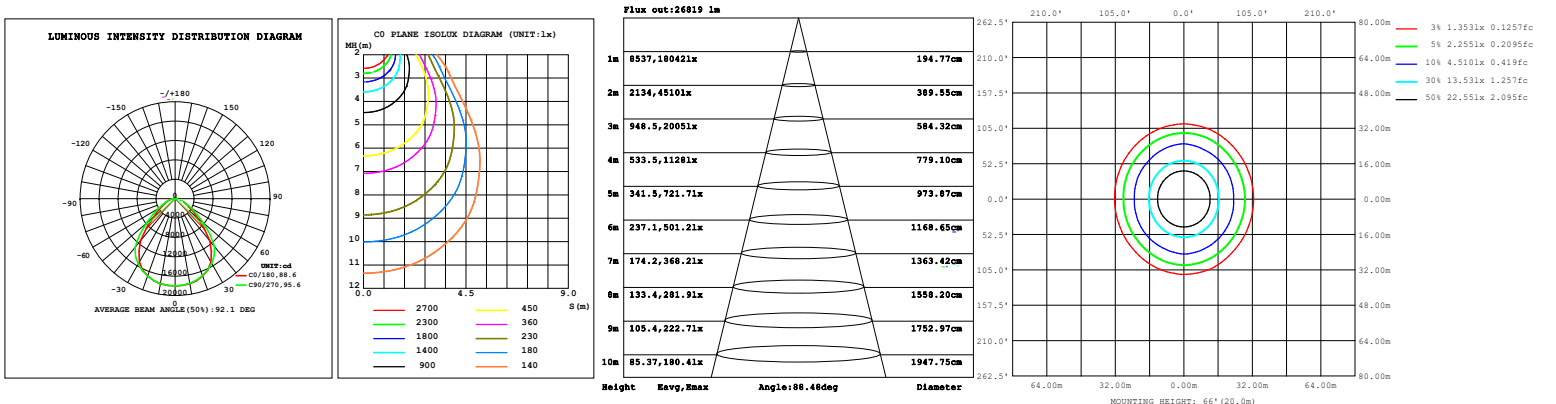

# Selectable Compact LED Linear High Bay

Wattage: 100W,115W, 135W ; 155W, 185W, 200W ; 200W, 230W, 270W; 270W, 340W, 400W

## PHOTOMETRICS

For complete IES files, please visit our website.

### LHB3.7F270/340/400W27-45K-G2

