

Selectable LED Glass Wall Pack light

Wattages: 28W,42W,56W,70W;48W,72W,96W,120W



The Selectable LED Glass Wall Pack Lighting Series can be widely used for Indoor or Outdoor (Wet Location) Excellent for Museums, Art Galleries, Shopping Malls, Office Buildings, Walls and many other applications.

**WATT/CCT
SELECTABLE**



Features:

- Lumileds LED, high luminous efficiency and long working life .
- High efficiency LED Driver, the wide range input voltage AC120-277V.
- Die Cast aluminium cooling design, high quality and better cooling for LED Tj < 85°C .
- Excellent Optics design, greatly improve the light utilization and evenness.
- **The 1-10V Dimming type is continuous.**

Packaging information:

❖ **WSD-GWP2842567W27-345K-D-P-G2:**

❖ **WSD-GWP48729612W27-345K-D-P-G2:**

Carton Size: 390MM X 235MM X 290MM (1Pcs/CTN)
(15.36" X 9.26" X 11.42")

SPECIFICATION								
TYPE	WSD-GWP2842567W27-345K-D-P-G2				WSD-GWP48729612W27-345K-D-P-G2			
WATTAGE	28W	42W	56W	70W	48W	72W	96W	120W
LUMEN	4800 lm	6393 lm	7880 lm	9808 lm	6990 lm	10447 lm	13422 lm	16767 lm
EFFICACY	> 150 lm/W							
CCT	3000K,4000K,5000K							
CRI	> 70							
INPUT VOLTAGE	AC120-277V							
LIGHTING ANGLE	96.2X110.5°				99.5X105.4°			
FACTORY SETTINGS	70W & 4000K				120W & 4000K			
LED TYPE	2835							
PF	> 0.95							
DRIVER EFFICIENCY	> 89%							
PROTECTION LEVEL	WET							
WORKING TEMPERATURE	-22°F ~ 113°F							
LIFE TIME	> 50000 hours							
WARRANTY	5 year limited							

Selectable LED Glass Wall Pack light

Wattages: 28W,42W,56W,70W;48W,72W,96W,120W

DIMENSION:

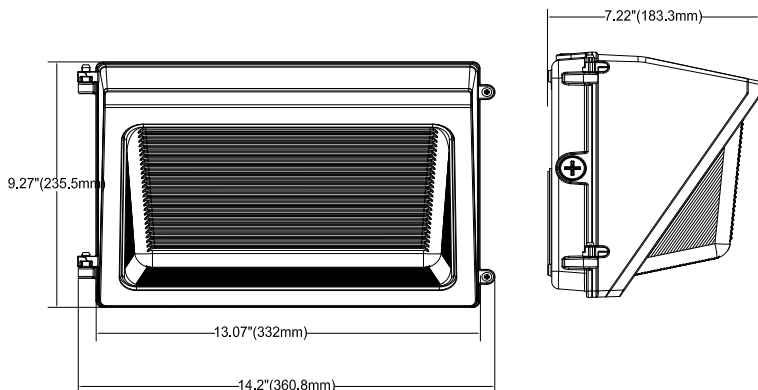

Specifications:

Shell materials: Aluminum & PC.
 Finish: Dark Bronze(Standard)
 Net weight : 10.2(lbs)
 Product Size:
 360.8mmX235.5mmX183.3mm
 14.20"X9.27"X7.22"

Control Module:



WATT/CCT
SELECTABLE



Selectable CCT

Three position sliding switch
 3000K / 4000K / 5000K



Selectable Power

Four position sliding switch
 100% / 80% / 60% / 40%

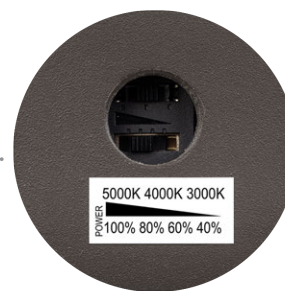

ORDERING INFORMATION:

EXAMPLE:

WSD-GWP2842567W27-345K-Z[D,W,B,S]-Y[Blank,P]-G2 / WSD-GWP48729612W27-345K-Z[D,W,B,S]-Y[Blank,P]-G2

WSD	GWP	2842567	27	345K	Z	Y	G2
COMPANY	PRODUCT	POWER	VOLTAGE	CCT	FINISH	CONTROL	UPDATE
WSD LED INC	GWP LED Glass Wall Pack light	2842567 28W/42W 56W/70W 48729612 48W/72W 96W/120W	27 AC120-277V	345K 3000K/4000K/5000K	D (Dark Bronze) W (White) B (Black) S (Silvery)	P (Photocell)	Second generation product

Selectable LED Glass Wall Pack light

Wattages: 28W,42W,56W,70W;48W,72W,96W,120W

PHOTOMETRICS:

For complete IES files, please visit our website.

WSD-GWP2842567W27-345K (28W&4000K)

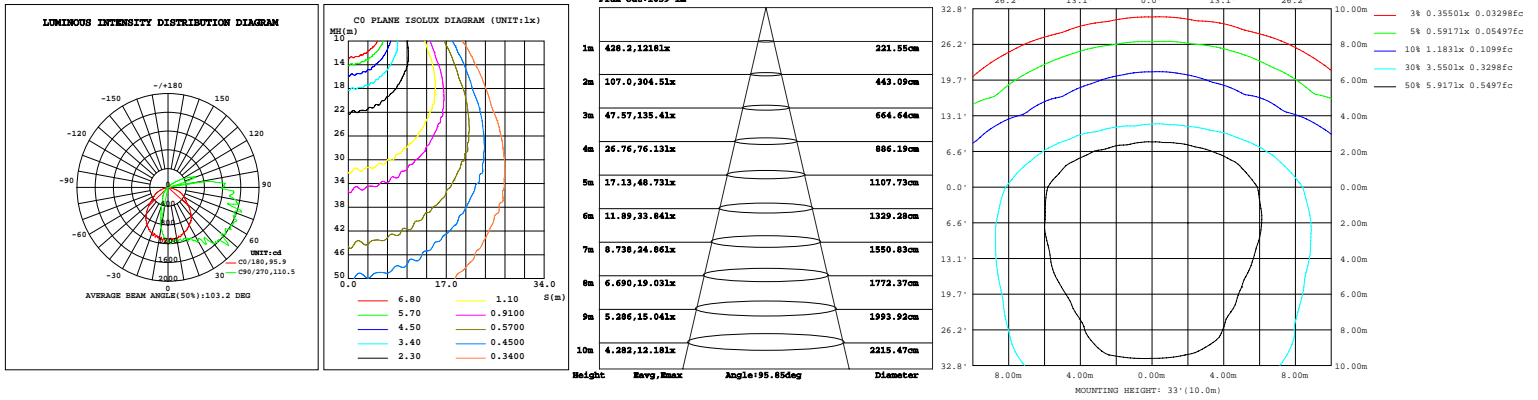

WSD-GWP2842567W27-345K (42W&4000K)

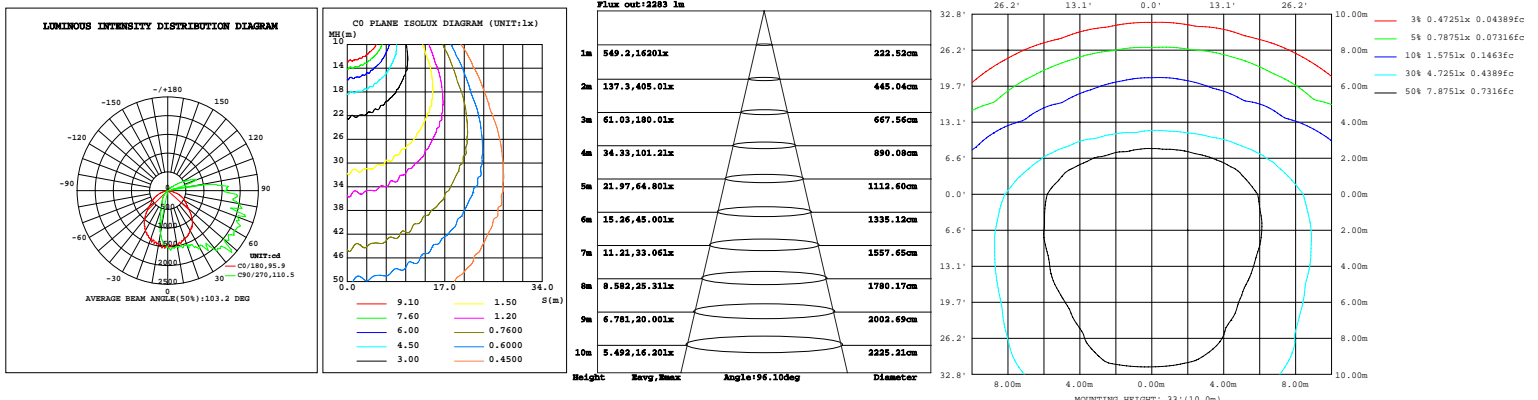

WSD-GWP2842567W27-345K (56W&4000K)

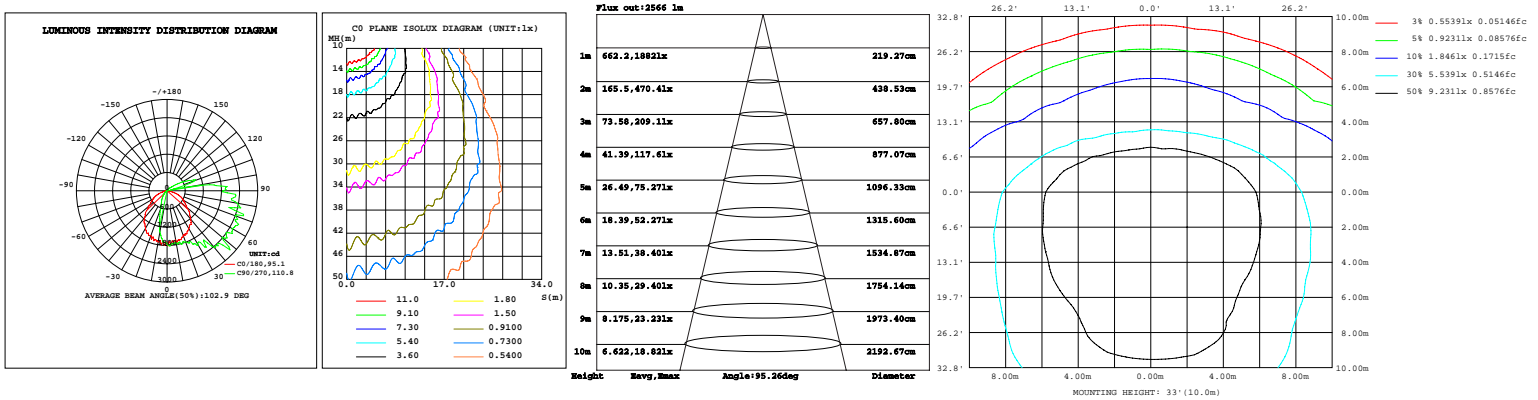

Selectable LED Glass Wall Pack light

Wattages: 28W,42W,56W,70W;48W,72W,96W,120W

PHOTOMETRICS:

For complete IES files, please visit our website.

WSD-GWP2842567W27-345K (70W&4000K)

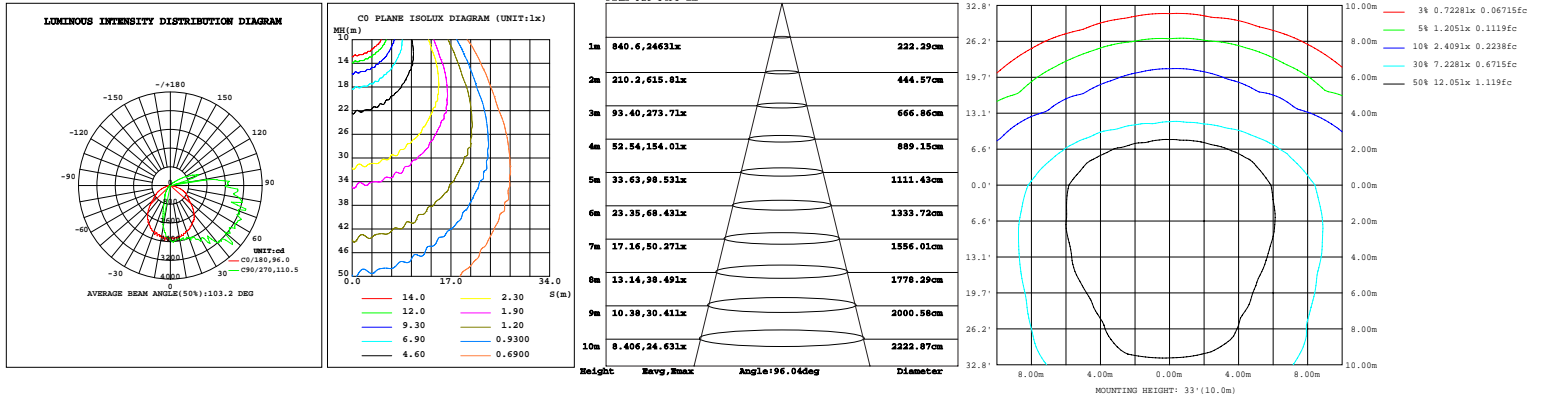

WSD-GWP48729612W27-345K (48W&4000K)

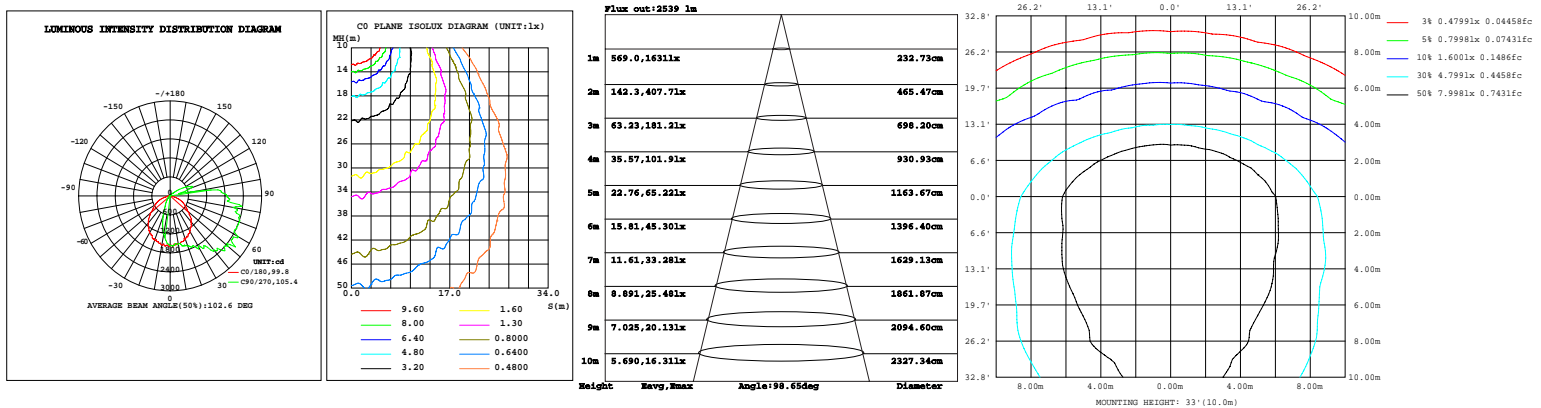

WSD-GWP48729612W27-345K (72W&4000K)

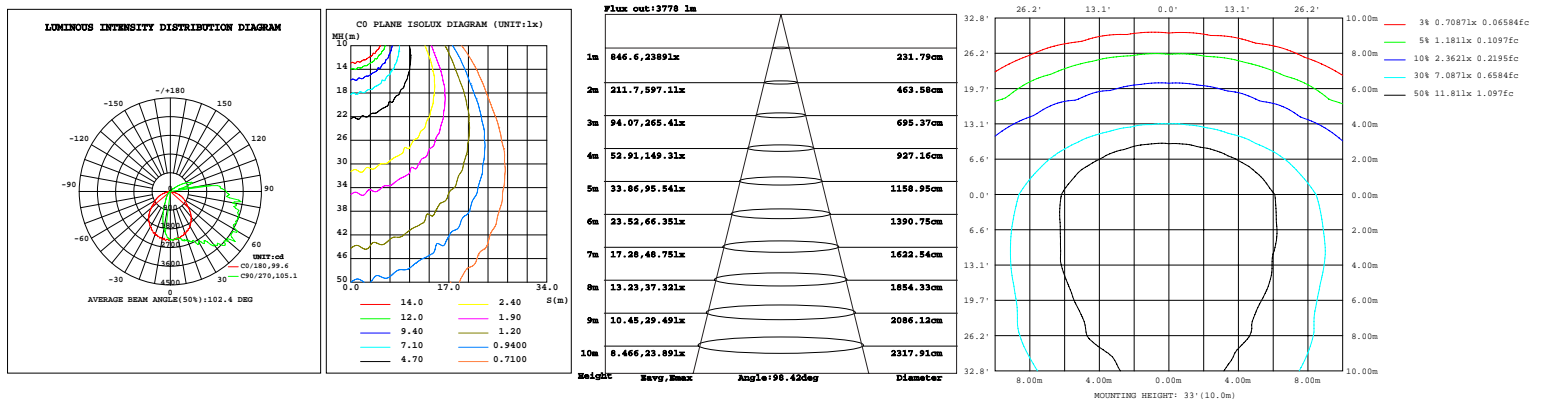

Selectable LED Glass Wall Pack light

Wattages: 28W,42W,56W,70W;48W,72W,96W,120W

PHOTOMETRICS:

For complete IES files, please visit our website.

WSD-GWP48729612W27-345K (96W&4000K)

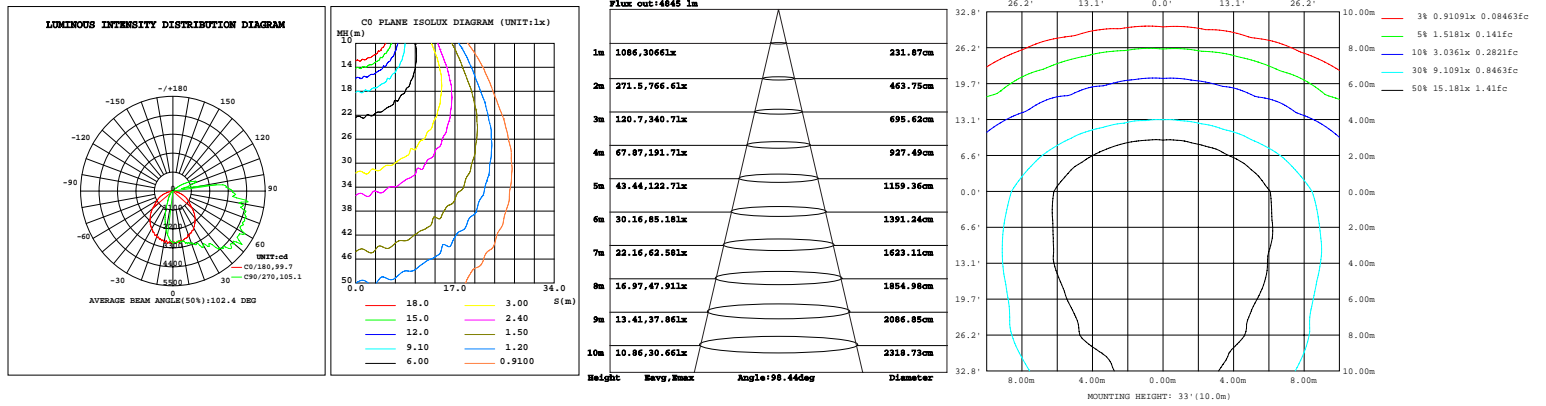

WSD-GWP48729612W27-345K (120W&4000K)

