

# CW-5300/6000/6100/6200/6260

## Industrial Circulating Chiller Installation & Operation Instructions

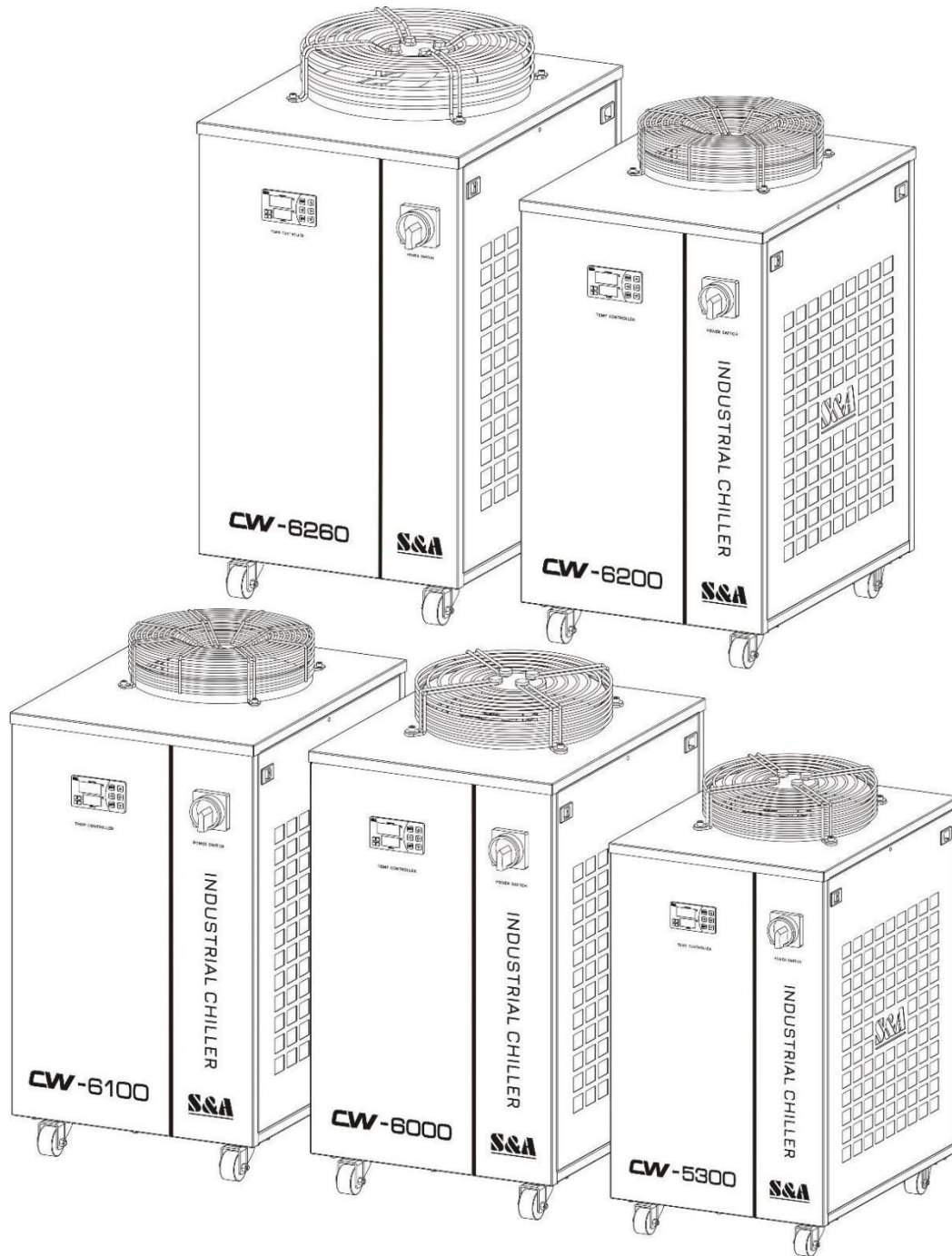

## **FOREWORD**

Thanks for your purchase of our product. Please read this manual carefully before using and keep it properly so that you can refer to it whenever you need information.









This manual is not a quality guarantee. Our company reserves the right to the interpretation of the correction of misprint and improperly described information and product improvement. The revised content will be edited into the reprinted user manual without prior notice.





## CONTENTS





<b>Notice .....</b>	<b>4</b>
<b>I. Overview .....</b>	<b>7</b>
<b>II. Model Illustration .....</b>	<b>7</b>
<b>III. Product Outlines &amp; Parts .....</b>	<b>7</b>
<b>IV. Installation .....</b>	<b>9</b>
<b>V. Operating States &amp; Parameter Adjustment .....</b>	<b>11</b>
<b>VI. Alarm &amp; Output Terminal .....</b>	<b>13</b>
<b>VII. Maintenance .....</b>	<b>14</b>









## Notice

Please strictly adhere to the usage guidelines and requirements provided, as accidents caused by improper operation (or use not in accordance with instructions) will be the responsibility of the user, and our company will not be held liable.

Notice		Operation Guideline
 Must-do	The operation should be carried out by professional technicians	Handling, piping installation, electrical, operation, maintenance, overhaul and other operations must be completed by personnel with professional skills.
 Forbidden	It is forbidden to be used beyond the range of specification	It is forbidden to use the equipment beyond the range of manual specifications.
 Forbidden	It is forbidden to be used in the explosive environment	It is not permitted to install the chiller in dangerous places with inflammable gas.
 Must-do	Electrical connection	a) The power supply must conform to the standard indicated in the nameplate or the manual; b) Use the standard cable, and select the standard wire diameter; c) The grounding wire must be installed and the connection must be reliable.
	It is forbidden to operate the equipment without a cover	There are live parts in the machine, it is not permitted to run machine without outer cover.
	Water-proof	Do not allow the equipment to encounter water.
 Must-do	Maintenance and repair	The operation must be carried out after 3 minutes of cutting off the power supply, because the high-voltage charging part in the equipment is not discharged within 3 minutes. Prohibit touch the live parts.
	Danger High Voltage	Contact with live parts can cause serious personal injury or death.
	Scald Burn Risk	Stay away from high-temperature areas.

Notice		Operation Guideline
 Must-do	Transport and installation	The equipment must be firmly fixed during transport and installation. Otherwise, there will be a danger of tipping or falling.
 Must-do	Electrical protection	The power cable terminal must be equipped with the electric leakage and overload protection device according to the rated current indicated on the equipment nameplate.
 Must-do	Stop running in abnormal state	When the equipment is abnormal, do not start the machine at this time, until the reason for the abnormal is known and there is no risk when starting the machine.
 Forbidden	Do not put fingers or other things into the gap of the equipment	There are rotating parts inside the device. Do not put fingers or other things into the gap of the equipment.
 Must-do	Refrigerant leakage	a) When the refrigerant leaks, please make sure that the ventilation is available. b) Avoid contacting with skin.

Notice		Operation Guideline
 Forbidden	Transportation with liquid is prohibited	The equipment is not allowed to be transported with liquid to prevent internal pipeline leakage.
 Must-do	Transport	a) The equipment should be fixed firmly before transportation to prevent the equipment from moving due to vibration and external forces. If there is excessive vibration and external force, the internal equipment may be damaged. b) Tilt angle should be $\leq 45^\circ$ . Otherwise, the refrigeration system will fail.
 Forbidden	Operating environment	a) It is forbidden to use in special environments such as high temperature, humidity, strong electromagnetic interference, etc. b) The equipment must be installed in a place where there is no direct sunlight and away from the fire sources.
 Must-do	Installation	a) The equipment must be installed on a horizontal surface. Otherwise, the refrigeration system will fail; b) It is forbidden to place objects within 1 meter around the air inlet and 1.5 meters around the air outlet. If the air inlet and the air outlet are blocked, the cooling ability that the equipment should have cannot be realized.

 Must-do	Before commissioning	a) Make sure that the water supply pipe of equipment is not blocked; b) It is necessary to check the water pipe and the water pump to confirm that there is a proper amount of water entering the water pump and exhaust it through the water pump exhaust valve, otherwise it will cause damage to the water pump; c) Confirm that the state of the equipment is normal and safe. Otherwise, there may be injury and damage.
 Warning	Gently move the motor impeller if the equipment isn't used for a long time	For equipment that has not been used for a long time, it may be difficult to start the pump at the first start. Please gently move the motor impeller before the equipment is powered on.
 Forbidden	The equipment is forbidden to be trampled on	Please do not step on or sit on the equipment. Otherwise, it may cause injury accidents such as falling or overturning.
 Must-do	Clean the air filter regularly	Clean the air filter at least once a week. If it is blocked, the cooling ability will decrease and the power consumption will increase, and the alarm will not work properly.
 Must-do	Equipment surface cleaning	a) Please use cleaning agents that are non-corrosive to metals and plastics; b) Please keep the cleaning agent properly after cleaning to prevent liquid leakage; c) The container for storing the cleaning agent must be sealed completely.
 Forbidden	No air blowing at the water outlet	A temperature probe is installed inside the water outlet, and it is forbidden to blow air inside the device with an air gun.
 Must-do	Wear protective gloves during maintenance, inspection and cleaning	a) The sharp edges of the condenser fins may cut the skin; b) The temperature of the internal compressor and refrigerant piping is very high, and direct skin contact may cause burns.
 Must-do	Anti-freezing	a) When the ambient temperature is lower than 2°C and the machine is shut down for a long time, it is necessary to drain the liquid and blow the water away in the system with compressed air, otherwise there is a danger of freezing and cracking the components and pipelines. b) When room temperature is lower than 2°C, it is recommended to use antifreeze with a concentration of not more than 30% containing ethylene glycol or propylene glycol.

## I. Overview

This product is an industrial cooling device designed and manufactured for laser cutting, laser welding, laser marking, laser engraving and other equipment that uses laser processing. It can provide a temperature-stable cooling medium for the above application scenarios.

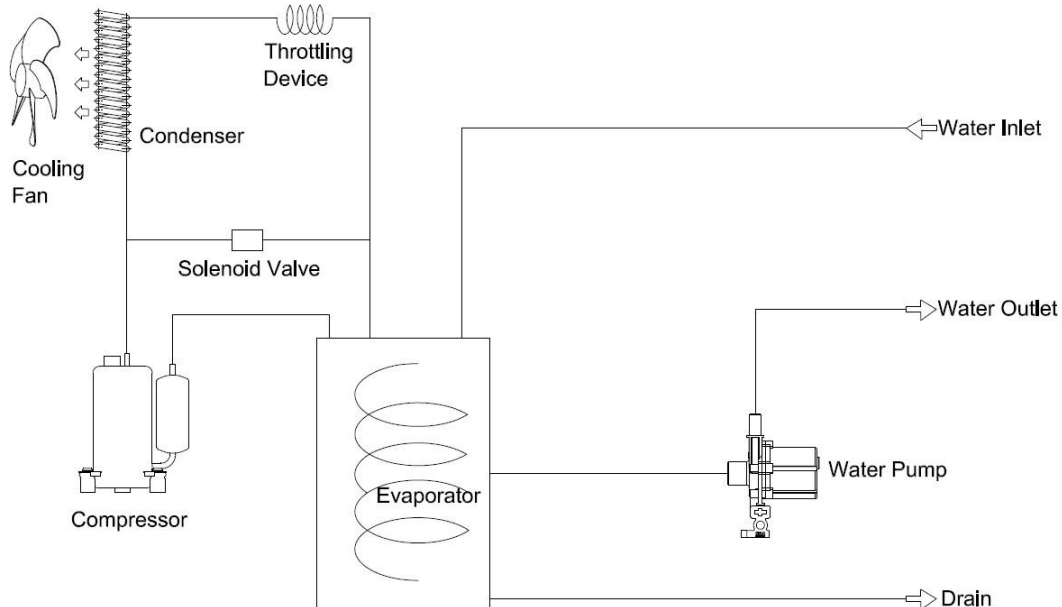

The chiller is composed of a compressor, a condenser, a throttling device (expansion valve or capillary), an evaporator, and a water pump. Its working principle is that the chiller's refrigeration system cools the water, and the water pump delivers the low-temperature cooling water to the equipment that needs to be cooled. Then the cooling water will take away the heat, heat up and return to the chiller, and then be cooled again and transported back to the equipment. In the refrigeration system of a chiller, the refrigerant in the evaporator coil absorbs the heat of the return water and vaporizes into steam. The compressor continuously extracts the generated steam from the evaporator and compresses it. The compressed high-temperature, high-pressure steam is sent to the condenser and later will release heat (heat extracted by the fan) and condense into a high-pressure liquid. After being reduced by the throttling device, it enters the evaporator to be vaporized, absorbs the heat of the water, and the whole process circulates constantly. Users can set or observe the working status of the water temperature through the temperature controller.

## II. Model Illustration

**CW- 6000 A H**

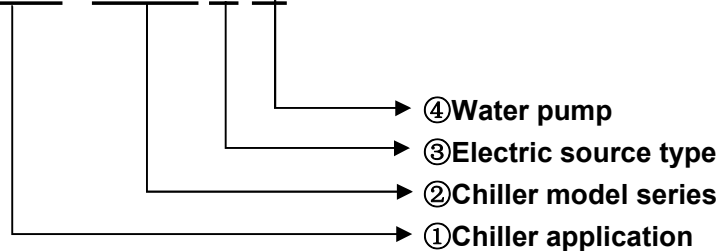

**Note:** This model description only contains the description of the company's main product codes, not all of them are listed. Please confirm with our company before ordering the specific model, our company has the final interpretation right about it.

## III. Product Outlines & Parts

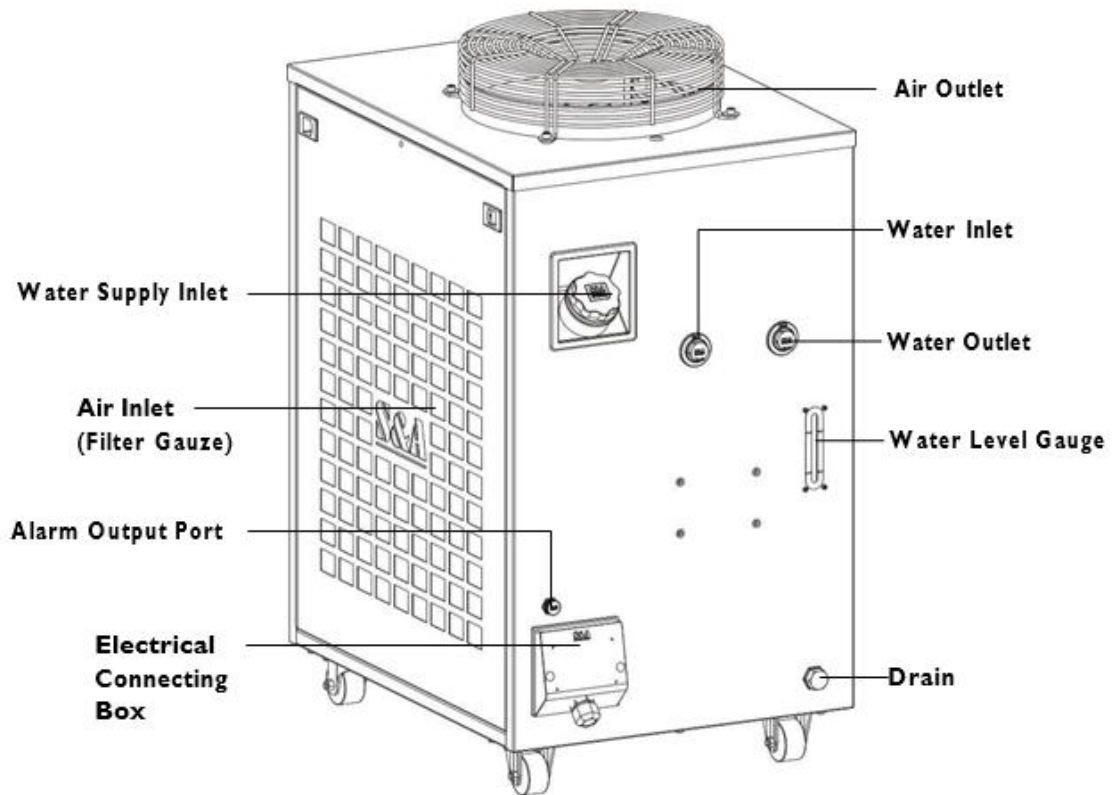
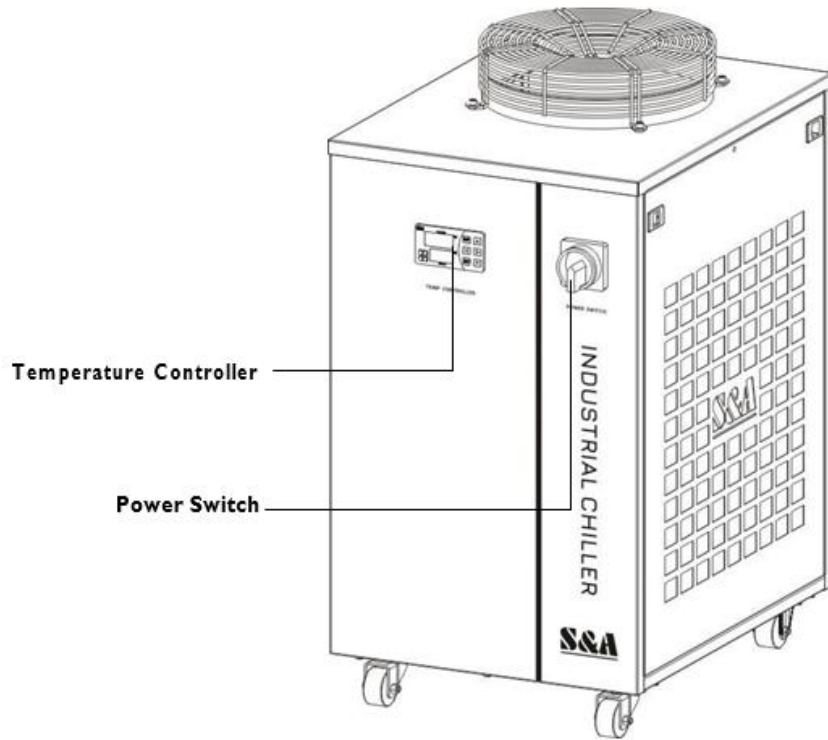

**Note:** The above-mentioned product outlines and part names are only for one of the models. The outlines and parts installation may be slightly different in different models.



## IV. Installation

**1. Open the package and check whether the machine is in good condition and whether the accessories are complete.**

**2. Please ensure that the working voltage of the chiller is stable and normal.**

Because the refrigeration compressor is sensitive to the power supply voltage, the normal working voltage of our company's standard products is 210~240V (110V model is 100~120V). If wider operating voltage range is necessary, customization is available.

### 3. Equipment installation conditions and requirements

(1) It must be installed on a horizontal surface and not tilted.

(2) The air outlet of the chiller should be at least 1.5m away from the obstacle, and the air inlet must be at least 1m away from the obstacle (See below diagram).

(3) Do not install in harsh environments such as corrosive, flammable gas, dust, oil mist, conductive dust, high temperature and humidity, strong magnetic field, direct sunlight, etc.

(4) Operating Environment

Ambient Temperature	Ambient Humidity	Altitude
0~40℃	≤90%RH	≤3,000m

(5) Medium Requirements

Cooling medium allowed by the chiller includes purified water, distilled water, high-purity water and other softened water. It is forbidden to use oily liquids, liquids containing solid particles, corrosive liquids, etc. Clean the filter element and replace the cooling water regularly (about three months is recommended) to ensure the normal operation of the chiller.

When the chiller is stored with water at room temperature lower than 2℃, it is necessary to add anti-freezer in the chiller water tank. It is recommended to use antifreeze with a concentration of not more than 30% containing ethylene glycol or propylene glycol. After the temperature warms up, change to purified water, distilled water or other suggested cooling media, let the chiller run for 30 minutes to remove the residual anti-freezer and drain it, and then refill with unused circulating water.

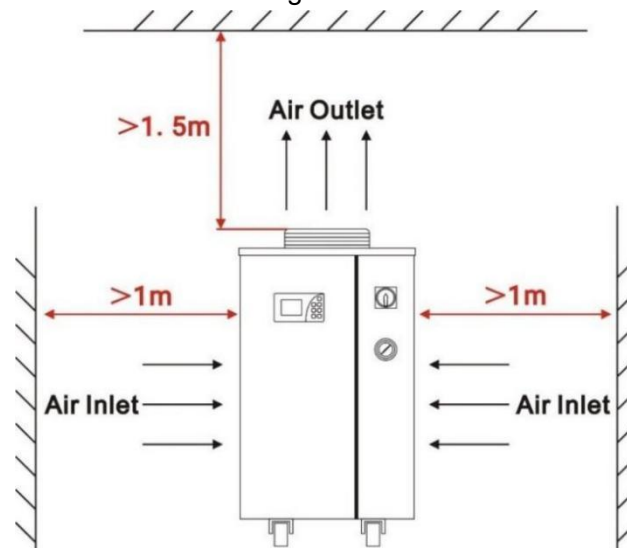

**4. Determine the direction of the pipeline layout according to the water inlet and outlet of the chiller, and ensure that the waterway is clean and**

free of impurities, so as to prevent impurities from entering the waterway and causing blockage or pump failure.

**5. Plug in the power cord and turn on the power switch (it is forbidden to start without water).**

(1) After turning on the power switch, the circulating pump of the chiller starts to work. When the new machine is turned on for the first time, there will be more air bubbles in the pipeline, which will cause the machine to alarm occasionally, and it will return to normal after a few minutes of operation.

(2) After starting the machine for the first time, check if the water pipes leak immediately.

(3) After turning on the power, if the water temperature is lower than the set temperature, it is normal that the cooling fan and other devices of the machine do not work. The temperature controller will automatically control the working status of compressors, solenoid valves, cooling fans and other components according to the set parameters.

**6. Electrical connection**

(1) Please select the cable based on the max. rated current indicated on the label of the chiller.

(2) Recommended reference standard for power cord diameter selection.

Rated current/ A	≤5	≤10	≤15	≤25	≤35	≤50
Wire diameter (copper wire)/ mm <sup>2</sup>	1.0	1.5	2.5	4.0	6.0	10.0

**Note: This data is provided according to IEC 60204-1 standard and only for reference. Standard cables must be used in the power cord.**

(3) The main circuit of the power supply must be equipped with appropriate electric leakage and overload protection devices, and the chiller must be well grounded.

(4) Less than ±10% of power supply voltage fluctuation and less than ±1Hz of frequency fluctuation are allowed, and keep away from electromagnetic interference sources.

**7. Fill Water & Exhaust Air**

(1) Fill Water

After the new machine is turned on, the air in the water pipe is emptied, and the water level of the water tank will drop slightly. In order to keep the water level in the green area, you can add water again. Observe and write down the current water level. After the chiller has been running for a period of time, observe the water level gauge again. If the water level drops significantly, check again if there is leakage in the water pipes.

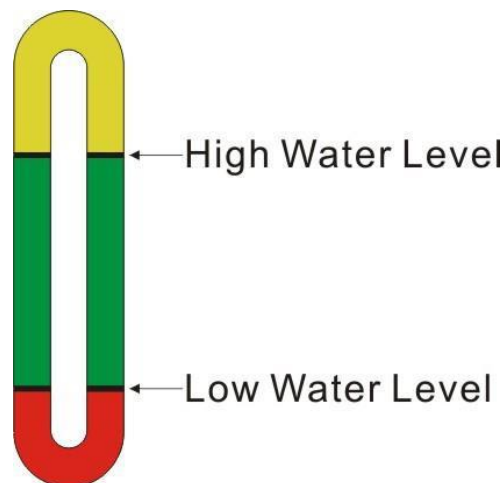

## (2) Exhaust Air

After adding water for the first time or replacing water, exhaust the air in the water pump to start use, otherwise the equipment will be damaged. The exhaust method is as follows:

Method 1: Under the state of shutting down, after adding water, remove the water outlet and connect the water pipe, drain for 2 minutes, and then install it firmly.

Method 2: Open the water supply inlet, after starting the machine (water flows), repeatedly press and fold the water pipe several times to drain the air from the pipe.

## 8. Test-run Check

(1) Check whether the pipeline connection is correct, and there must be no bubbling or water leakage;

(2) Check whether the inlet and outlet water ball valves are open and the drain valve is closed;

(3) Check the liquid level of the water tank;

(4) Confirm that the electrical wiring of the equipment is connected correctly;

(5) Confirm whether the equipment is grounded.

## V. Operating States & Parameter Adjustment

The new T-506D intelligent temperature controller is designed with intelligent control mode. It will self-adjust controlling parameters according to room temperature for meeting equipment cooling requirements.

The new T-506E intelligent temperature controller is designed with constant temperature control mode with water temperature maintained at 25°C. Users can adjust it as needed.

T-506D and T-506E controllers are of same functions and structure except factory setting.

### 1. Temperature control panel introduction

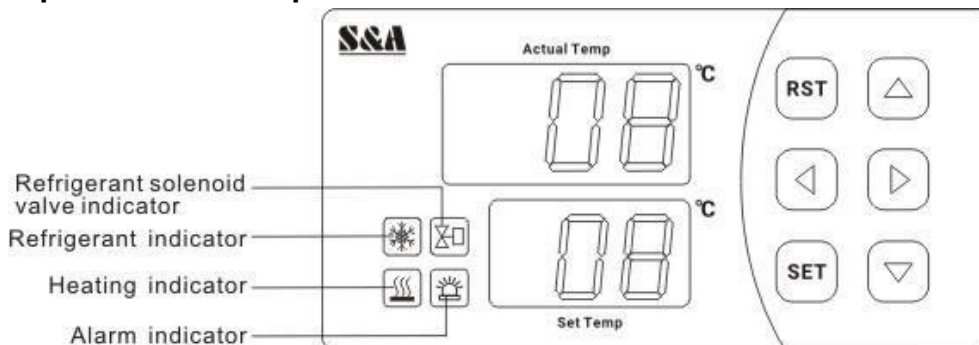

### 2. Indicators of temperature controller working status

Refrigeration indicator - During refrigeration process, this indicator is on. In constant temperature control mode, this indicator is off. During the delay process, this indicator flashes.

Refrigerant solenoid valve indicator - When connected, this indicator is on. When disconnected, this indicator is off.

Heating indicator - When connected, this indicator is on. When disconnected, this indicator is off.

Alarm indicator - When connected, this indicator is on. When disconnected, this indicator is off.

### 3. Quick setting

Press "SET" key to set the temperature. The upper window indicates F0 (F1 is indicated in intelligent control mode) while the lower window flashes with current value. Then press "↑" or "↓" key to change the value which will be memorized by the temperature controller. Press "RST" key to save the data and exit.

4. Press “→” key once to enter status display menu and it indicates t1 which suggests temperature of room temperature sensor.

Press “→” key twice to indicate t2 which suggests flow rate. (L/min, with 0.1 resolution)

Press “→” key three times to return to normal operation.

5. When first powered on, press “↓” key to cancel delay time and connect the compressor.

#### 6. User parameter setting (F0~F11 is available)

“↑” and “↓” keys are for changing and saving data. “←” and “→” keys are for switching items. Press and hold “SET” key, “↑” key and “↓” key for 6 seconds to enter parameter setting until the lower window indicates PAS and the upper window indicates 00. Press “↑” or “↓” key to revise password (F7 is for revising password) and then press “SET” key. If the password is correct, the lower window indicates F0 and the parameter is available for revision. If the password is wrong, it will return to temperature display. If there is no action within 20 seconds, the temperature controller will also automatically exit parameter setting status. Press “RST” key to save the data and exit.

#### 7. Restore to factory settings

After the power is on for 30 seconds, press and hold “↑” and “↓” keys for 3 seconds until it displays “rE”. The supplier parameter and user parameter will restore to factory value. 3 seconds later, it will return to temperature display.

#### 8. Alarm codes description

E1	E2	E3	E4	E5	E6	E7
Ultra-high room temperature	Ultra-high water temperature	Ultra-low water temperature	Room temperature sensor failure	Water temperature sensor failure	External input alarm	Flow alarm

#### 9. Advanced parameters adjustment examples

Order	Code	Items	Value in Case 1	Value in Case 2
1	F0	Temperature setting		25
2	F1	Temperature Difference Values	-3	
3	F2	Refrigeration return difference	0.5	2.0
4	F3	Way of control	1	0
5	F4	Alarm for ultra-high water temperature	15	5
6	F5	Alarm for ultra-low water temperature	15	10
7	F6	Alarm for ultra-high room temperature	45	45
8	F7	Password	8	8
9	F8	The allowed highest water temperature	31	30
10	F9	The allowed lowest water temperature	25	5
11	F10	Flow alarm	0.5	0.5
12	F11	Communication address	1	1

Case 1: Cooling water temperature is controlled by the intelligent control mode. The required water temperature is from 25°C to 31°C and the set water temperature is 3°C lower than the air temperature. Under the condition of constant air temperature, the fluctuation should not exceed  $\pm 0.5^\circ\text{C}$ . The alarm will be triggered when the water temperature is 15°C lower or higher than the target temperature (e.g., if the air temperature is 30.0°C, cooling water temperature is between 27.5 °C to 26.5 °C , if the air temperature is up to 30.5 °C , water temperature will be between 28.0°C to 27.0°C).

Case 2: The cooling water temperature is controlled by the constant mode. It is required that the water temperature is kept constant at 25°C, and the fluctuation should not exceed  $\pm 2^\circ\text{C}$ . The ultra-high temperature alarm will be triggered when the water temperature is 5 °C higher than the target temperature; and the ultra-low temperature alarm will be triggered when the water temperature is 10°C lower than the target temperature. The water temperature setting can be easily adjusted from 5°C to 30 °C by user setting.

## VI. Alarm & Output Terminal

In order to guarantee the equipment will not be affected while abnormal situation happens to the chillers, the chillers has been designed with an alarm protection function.

### 1. Alarm output terminals and wiring diagram.

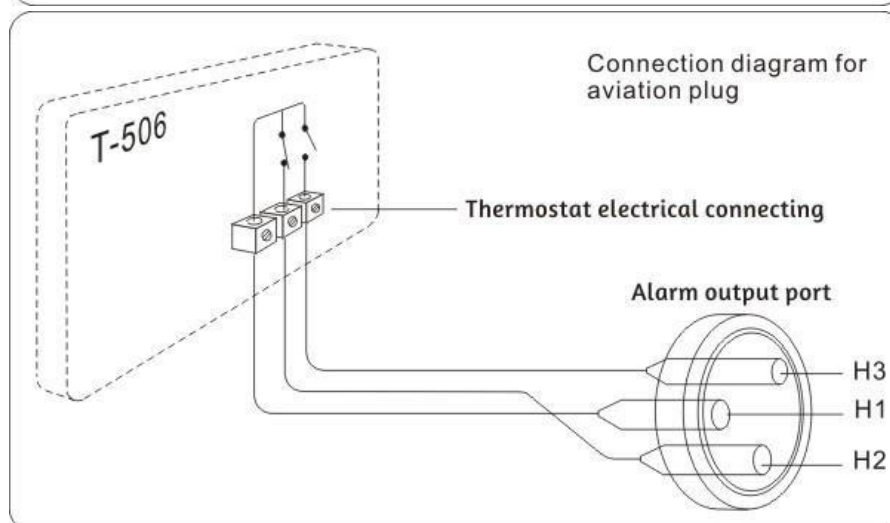
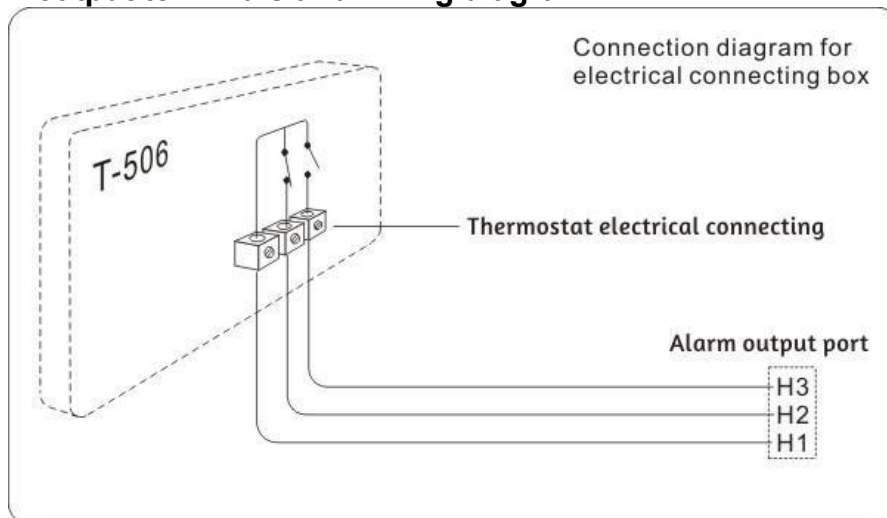

## 2. Alarm causes and working status table.

Condition \ Display	Alarm code	Buzzer	H1 and H2	H1 and H3
Circulating pump works properly			open circuit	connected
Ultra-high room temp	E1	Sounds	connected	open circuit
Ultra-high water temp	E2	Sounds	connected	open circuit
Ultra-low water temp	E3	Sounds	connected	open circuit
Room temp sensor failure (constant temp invalid)	E4	Sounds	connected	open circuit
Water temp sensor failure	E5	Sounds	connected	open circuit
Alarm of water shortage	E6	Sounds	connected	open circuit
Low flow rate / water flow alarm	E6/E7	Sounds	connected	open circuit
Circulating pump failure	E7	Sounds	connected	open circuit
Chiller power failure			connected	open circuit

**Note:** The alarm output port is connected with a set of normally open and normally closed contacts of the relay inside the machine. The working current should be smaller than 3A while the working voltage should be smaller than 300V.

## VII. Maintenance

For equipment maintenance, firstly the machine must be stopped and the power must be cut off. Wait 3 minutes before starting the maintenance process, otherwise there will be a risk of electric shock. When the ambient temperature is lower than 2°C, the internal water must be drained when the machine is shut down for a long time.

Disassemble the dust filter regularly for cleaning and use a compressed air gun to blow off the dust accumulated in the condenser. (It is recommended to clean it once a week, and the chiller should not without the dust filter, except for a quick cleaning process.)

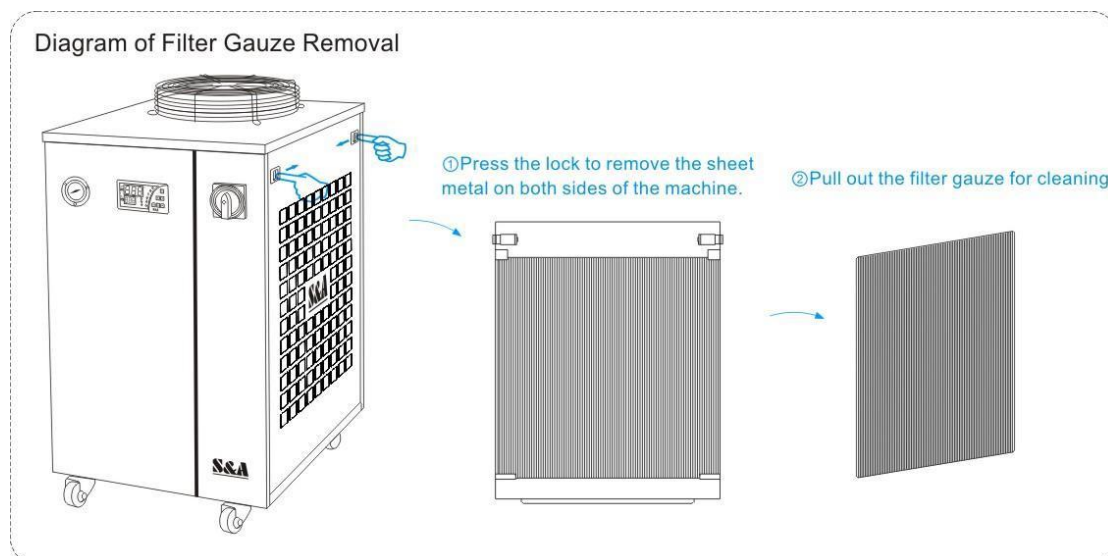

## VIII. Simple Troubleshooting

Failure	Failure Cause	Approach
<b>Machine turned on but unelectrified</b>	Power cord is not plugged in place	Check and ensure the power interface and the power plug is plugged in place and in good contact.
	Fuse burnt-out	Pull out the fuse box from the power supply interface of the chiller, check the fuse, replace with spare fuse if necessary, and check whether the power supply voltage is stable. Check and ensure the power interface and the power plug is plugged in place and in good contact.
<b>Flow Alarm, connecting the water outlet and inlet with a water pipe directly, but still no water flow</b>	Water level in the water tank is too low	Check the water level gauge display, add water until the level shown in the green area; And check whether the water circulation pipe leaks.
<b>Flow alarm occurs while chiller is working. However, when the water outlet and inlet of the chiller are connected directly with a water pipe, water flows and no alarm occur.</b>	Water circulation pipes are blocked or a pipe is bent or deformed	Check the water circulation pipe.
<b>Ultra-high water temperature alarm</b>	Blocked dust gauze, bad thermolysis	Disassemble and clean the dust gauze regularly.
	Poor ventilation for air outlet and inlet	Ensure a smooth ventilation for air outlet and inlet.
	Voltage is extremely low or unstable	Improve the power supply circuit or use a voltage regulator.
	Improper parameter settings on thermostat	Reset the controlling parameters or restore the factory setting.
	Switch the power on and off frequently	Ensure sufficient time for refrigeration after starting the chiller (at least 5 minutes).
	Excessive heat load	Reduce the heat load or use other model with larger cooling capacity.
<b>Ultra-high room temperature alarm</b>	The working ambient temperature is too high for the chiller	Improve ventilation and ensure that the machine is operated below 40°C.
<b>Serious problem of condensate water</b>	Water temperature is much lower than ambient temperature and the ambient humidity is high	Increase water temperature or insulate pipes.
<b>Water drains slowly from drain port during water changing</b>	Water supply inlet is not open	Open the water supply inlet
<b>Startup flow alarm</b>	Bubble in the water pipe	Exhaust the air

Attachment -  
Schematic CW-5300  
(flow sensor)

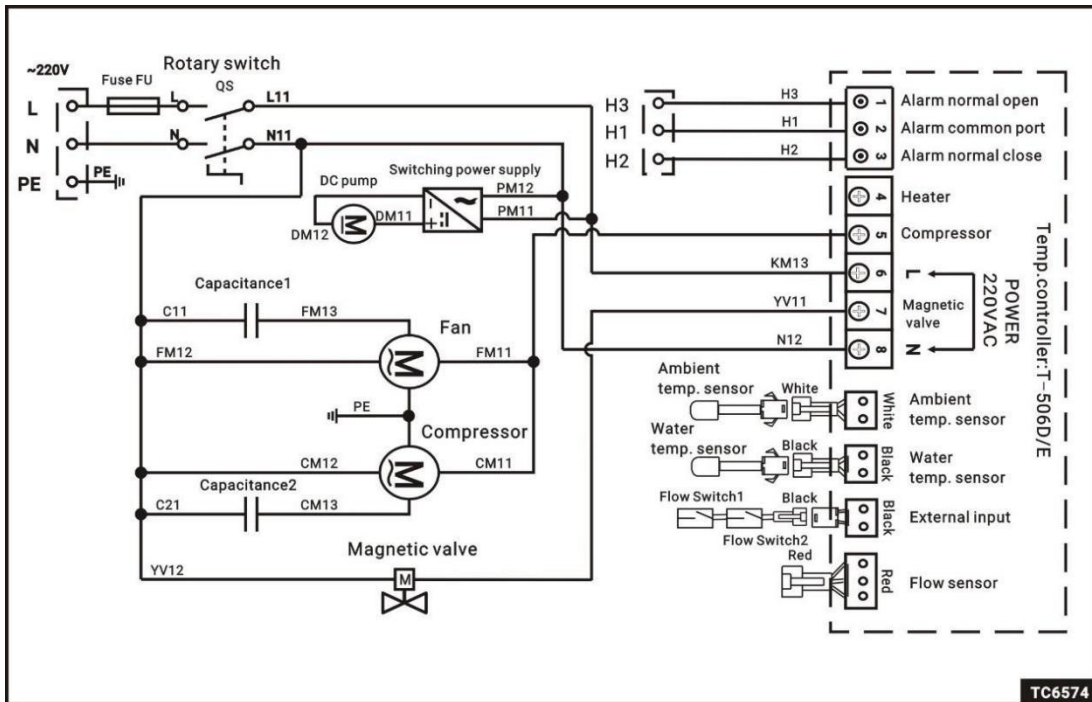
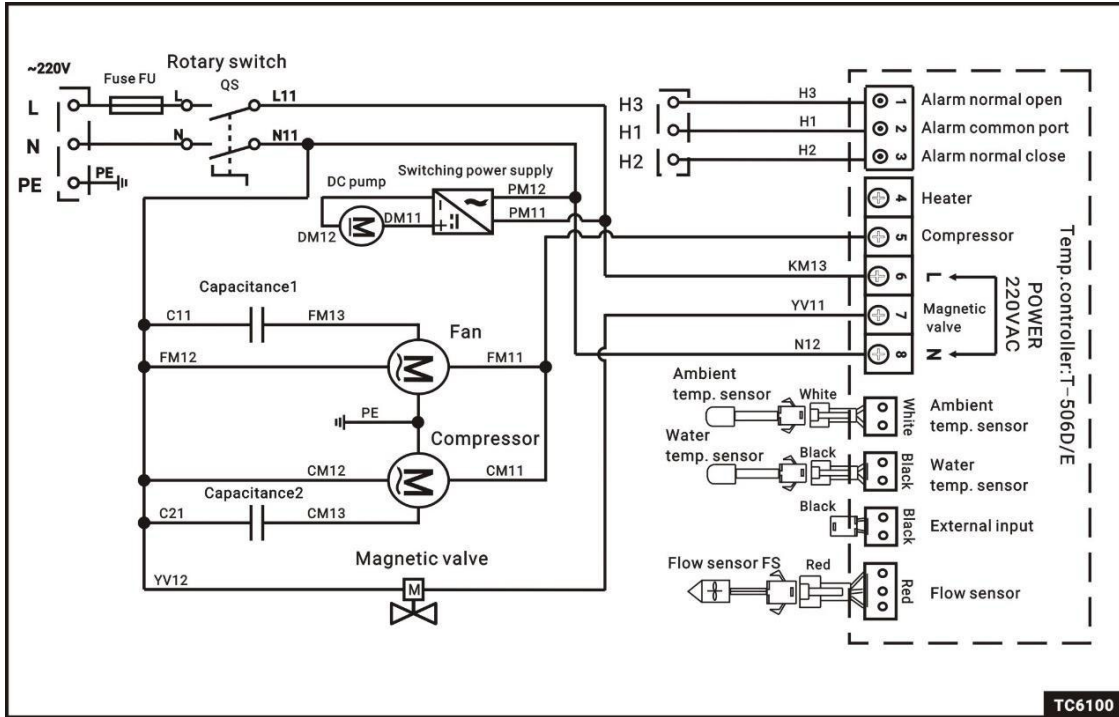

CW-5300 (flow switch)



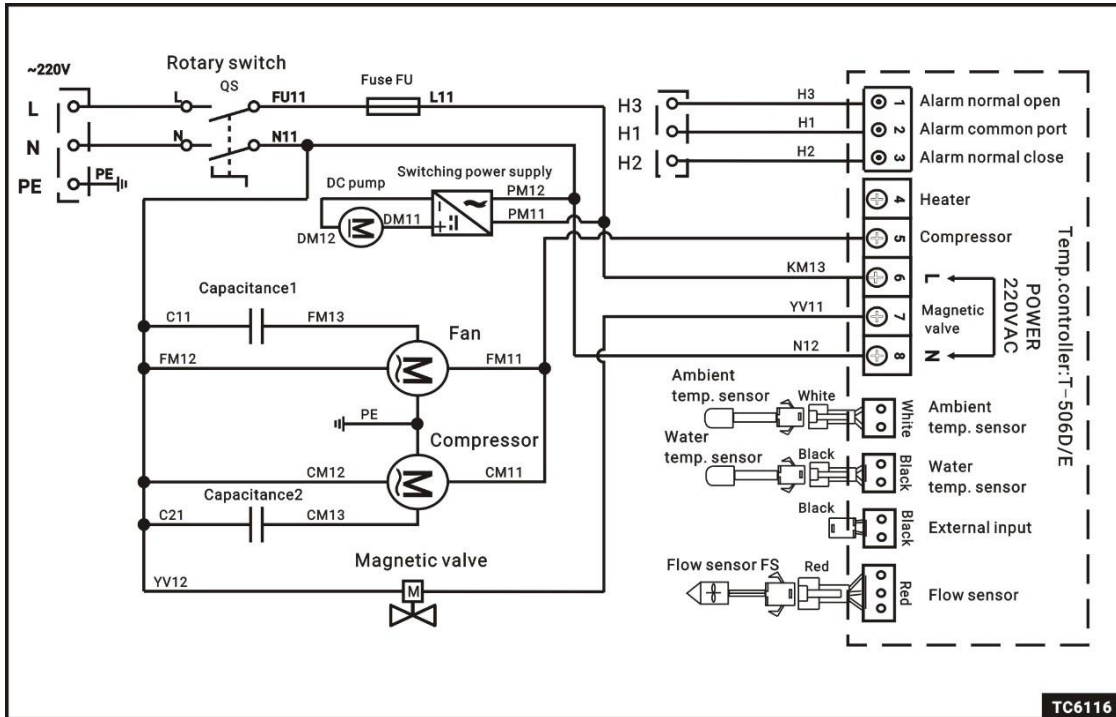

*CW-6000 (flow sensor)*

*CW-6000 (flow switch)*

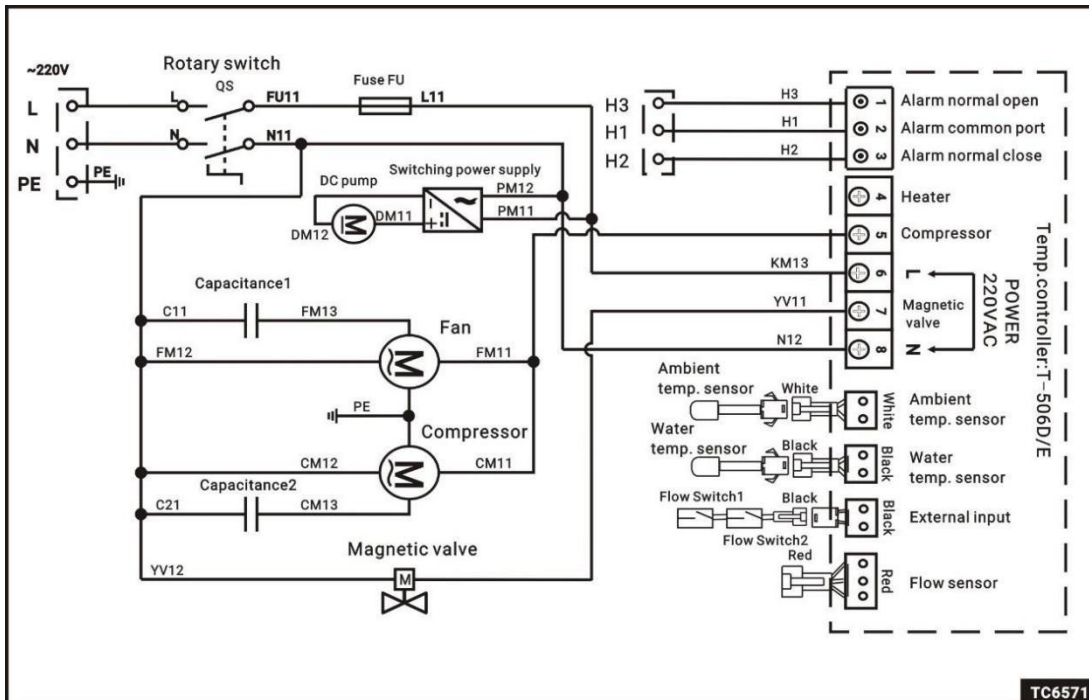

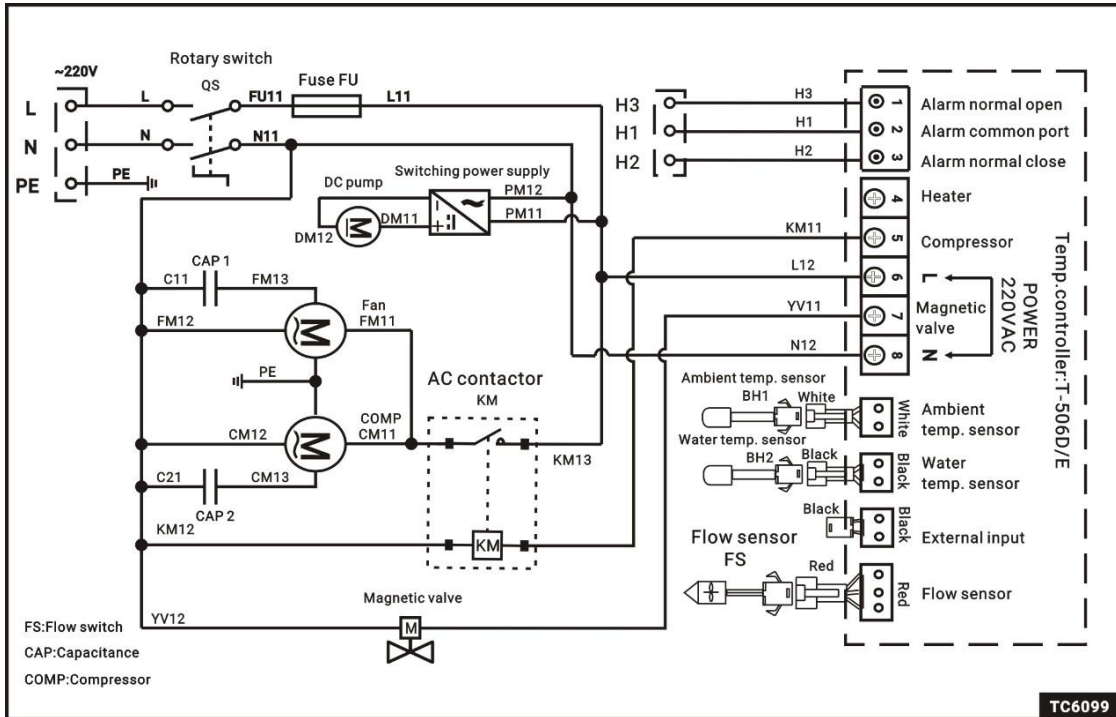

CW-6100/6200/6260 (flow sensor)

CW-6100/6200/6260 (flow switch)

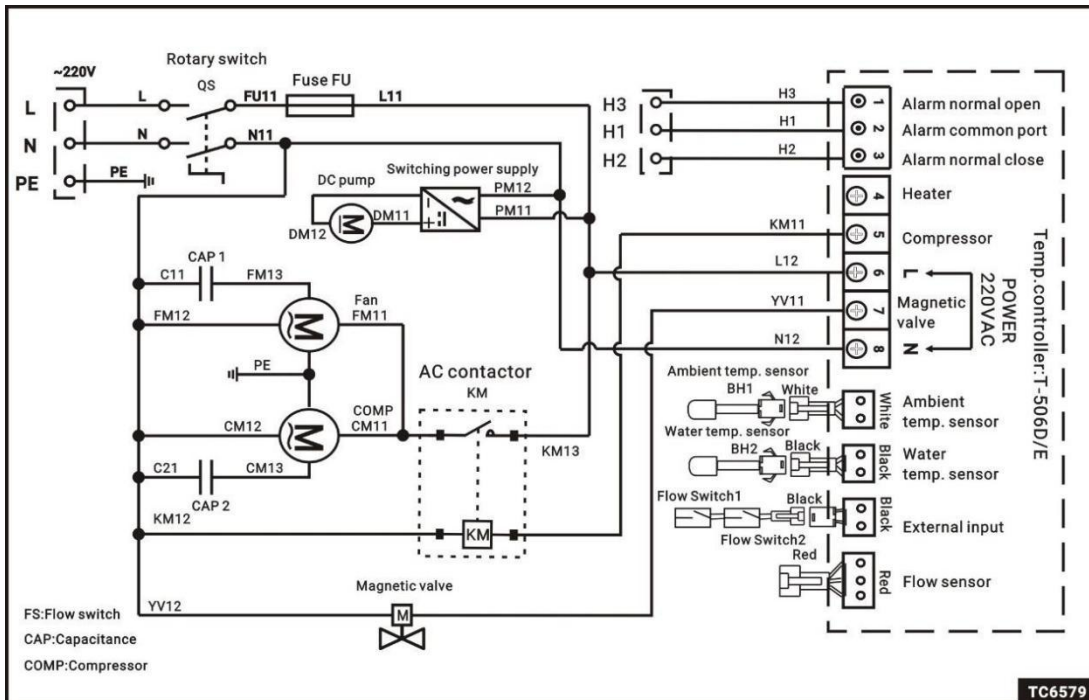

Brand: 特域机电 S&A

Product Name: Water Chiller

Manufacturer's Company Name: Guangzhou TEYU Electromechanical Co., Ltd

Manufacturer's Address: No. 50, Zhongchuang Road, Shengshi Industrial Zone, Zhongcun Town, Panyu District, Guangzhou

Sales Company: Shanghai Top Nine Industrial Co., Ltd.

Seller's Company Address: No.208 Wulian Road, Room164, Shanghai Pudong New District, China, 200129, CN

E-mail: coletechcn@126.com

TEL: +86 18017012480

EC	REP	EU contact address: Apex CE Specialists GmbH Habichtweg 1 41468 Neuss Germany E-mail: Shirleydai2022@gmail.com
----	-----	---



CENTRE OF TESTING SERVICE  
OPERATE ACCORDING TO ISO/IEC 17025

## EC DECLARATION OF CONFORMITY

EU - Machinery Directive -

This declares that the following designated product:

### Industrial Water Chiller

Model No.: CW-6100, CW-6200, CW-6300, CW-6000, CW-6250, CW-6500,  
CW-3000, CW-5000, CW-5200, CW-5300, CW-7000, CW-7300, CW-7500,  
CW-7800, CW-7900, CW-8000, CW-9000, UP-5000, UP-5100, UP-5200,  
RM-300, RM-500, CWUL-05, CWUL-10, CWUL-20

Brand Name: S&A

(Product identification)

complies with the requirements of the European Community Directive 2006/42/EC.

This declaration is awarded following tests carried out on samples of the product referred to above.

Assumption of compliance of the product with the requirements relating to the  
Machinery Directive (MD) was based on the following standards:

EN 60204-1: 2018

(Identification of regulations / standards)

This declaration is the responsibility of the applicant

GUANGZHOU TEYU ELECTROMECHANICAL CO., LTD.

No.50, Zhongchuang Road, Zhongcun town, Panyu District, Guangzhou, China

(Name / Address)



THIS DOC IS ONLY VALID IN CONNECTION WITH TEST REPORT NUMBER: CTS190508056-LO

### MANUFACTURER / IMPORTER

### TEST LABORATORY

This is the result of test, that was carried out from the submitted type-samples of a product in conformity with the specification of the respective standards.

The declaration holder has the right to fix the CE-mark for MD on the product complying with the inspection sample.

May 28, 2019

(Date)

(Company stamp)

CTS (Ningbo) Testing Service Technology Co., Ltd.

Fl.1 & 8 West, Bldg. B, No. 66, Qingyi Rd., Hi-Tech Zone,  
Ningbo, Zhejiang, China

(Date)

(Surname, forename)

(Company stamp)



DECLARATION OF CONFORMITY