



CIRCOOTER

R3

User Manual







Contents

Product Safety Notice	01
What's included	02
Product Overview	03
Specification	04
Display Content	05
Screen	08
E-SCOOTER APP	09
Assemble	10
Attention	10
Riding Basics	11
Riding Notice	13
Dangerous Actions	14
Charging	14
Disc Brake Adjustment	15
Daily Care and Maintenance	16
Limited Warranty Statement	17
Error Code	18
FAQ	19
Contact Us	19



Product Safety Notice

Don't Ride Until You Read This:

-  Always wear a helmet, elbow pads, and knee pads when riding your electric scooter.
-  Make sure your electric scooter has a full charge, and all screws are closely tightened before riding.
-  Always be aware of local road laws, and follow them.
-  Do not ride under the influence of drugs or alcohol.
-  Always respect pedestrians.
-  Do not ride under heavy rain or extreme temperature conditions. Do not ride in a puddle deeper than 1.5 inches. The electric scooter may slide causing injury. These conditions may damage the electronics and void the warranty.

Warning Message

Avoid Water --- The electric scooter has an IPX4 rating. The electronics may be damaged due to water and water damage is not covered by our warranty. Riding in heavy rain or extreme temperature conditions is also very dangerous and may result in injury.

Keep Away from Fire --- Do not bring the electric scooter near the fire.

Proper Storage --- Avoid prolonged exposure to sun or rain and avoid storage in places with high temperatures or corrosive gas.

Abuse --- We do not cover physical damage due to negligent care and extreme riding.

Safety Ride --- Whenever you ride the electric scooter, you risk severe injury or even death from loss of control, collisions, and falls.

Be Careful --- Use caution and ride at your own risk.

No Modification --- Only use original brand accessories. Unauthorized modification is strictly prohibited.

Before Riding --- Be sure to check that the entire scooter is in good condition, such as whether the locking screws of the motor, front wheels, folding joints, etc. are fastened and reliable. Do not ride at will before correcting any problems.

Before Riding --- be sure to check that the braking system is functioning properly, also be sure to check that all safety labels are in place and you understand the safety warnings.

No Hanging --- Do not hang heavy objects on the handlebars.

No Use --- Pregnant women, the disabled, and those with heart problems should not use this product.

Save Electricity --- To conserve electricity, do not brake frequently, ride against the wind, or carry heavy loads including other people.

Age Limit --- The electric scooter should never be used by children under the age of 18.

Not Overload --- Never exceed the 200 kg (440 lbs) maximum load rating.

Moving Parts Hazard --- Keep hands and all body parts away from moving parts while operating the electric scooter.

Caution --- Make note that additional insurance may be required to cover situations you encounter while riding an electric scooter. It is recommended that you contact an insurance company or broker for advice and consultation.



What's included

Carefully check what's included in the package box, if anything is missing or damaged, please contact circooter customer service for support: support@circooter.com

Keep the package box to ship back the scooter if necessary.

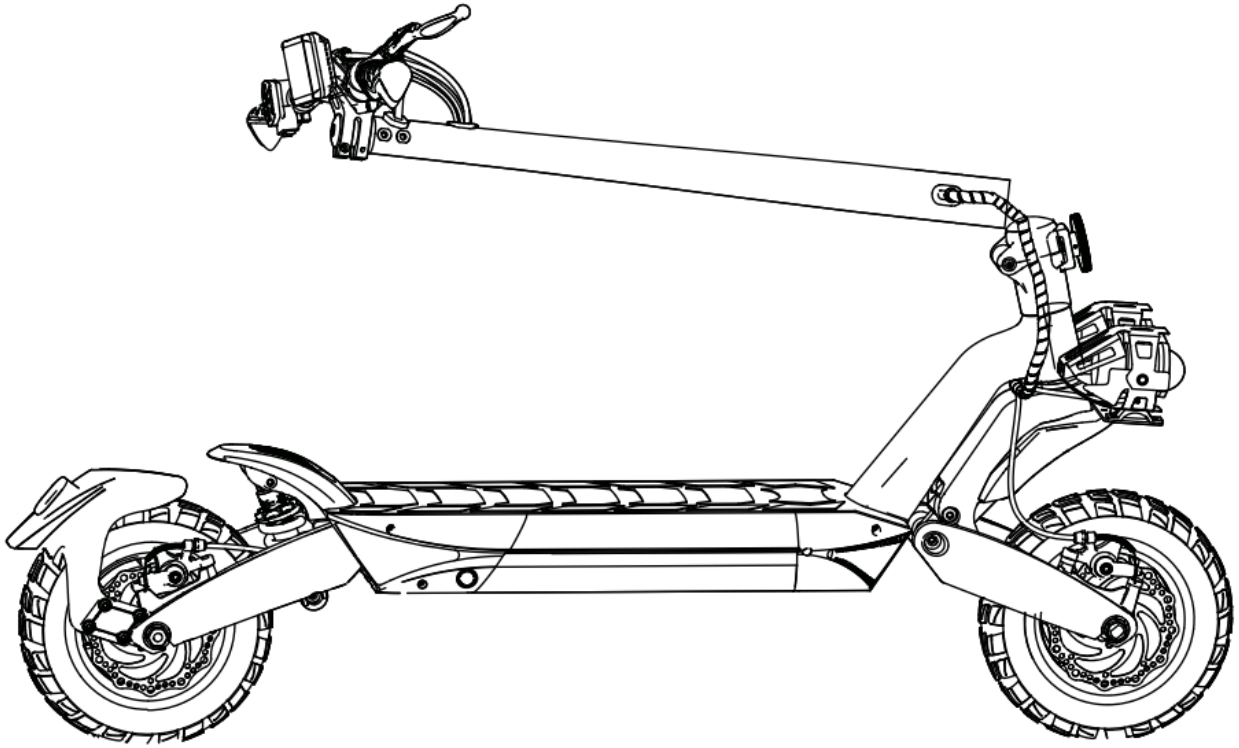

1 x Scooter

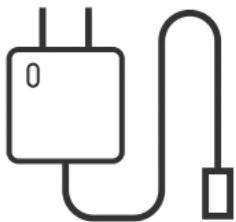

1 x Charger

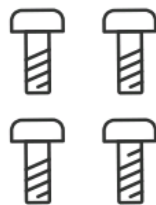

4 x Screws



1 x Allen Wrench



Product Overview

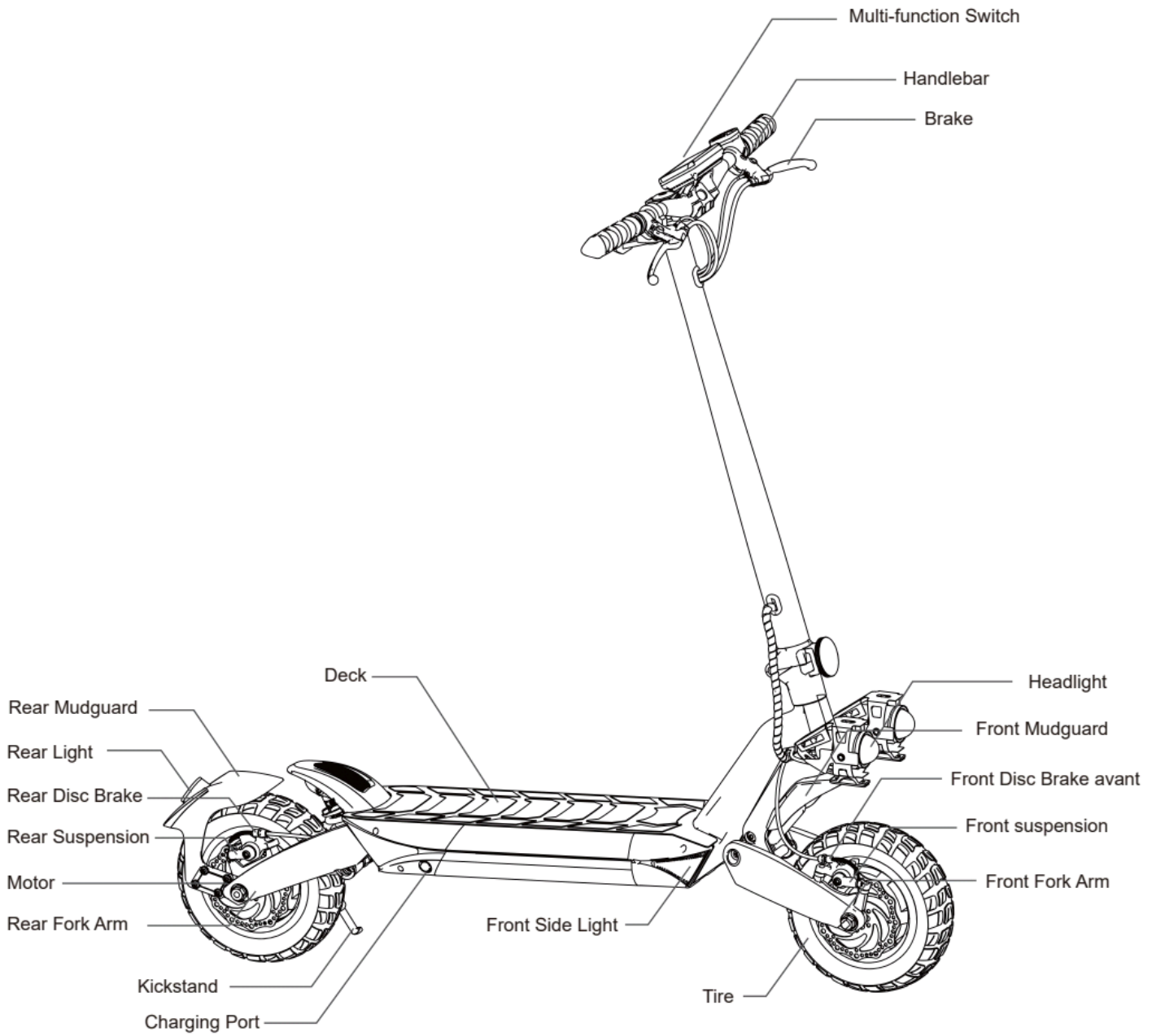



Specification

Project	Content	Parameters
Scooter Parameters	Unfolded Dimensions	51*26*47 IN / 129*67*118 CM
	Folded Dimensions	51*26*22 IN / 129*67*55 CM
	Net Weight	59.2 LB / 26.86 KG
	Top Speed	25km/h
	Max. Range	21-25 Miles / 35-40 KM
	Hill Climbing	25% - 30% Grade
	Terrain	All-Terrain Wheels
	Operating Temperature	14 °F - 104 °F
	Storage Temperature	-4 °F - 104 °F
	Waterproof Rating	IPX4
	Charging Time	7-8 H
Battery Parameters	Rated Voltage	48V
	Capacity	15 Ah
Motor Parameters	Wheel Size	10 Inches
	Tire Type	Off Road Tubeless Tire
	Rated Voltage	48 V
	Power	800 W
	Motor Type	Brushless DC Motor
Brake	Brakes	Front and rear mechanical disc brake + electric brake
Charger	Input Voltage	100 V ~ 240 V
	Output Voltage	54.6 V
	Output Current	2 A
	Maximum Load	440LBS (200KG)



Display Content



Display Content

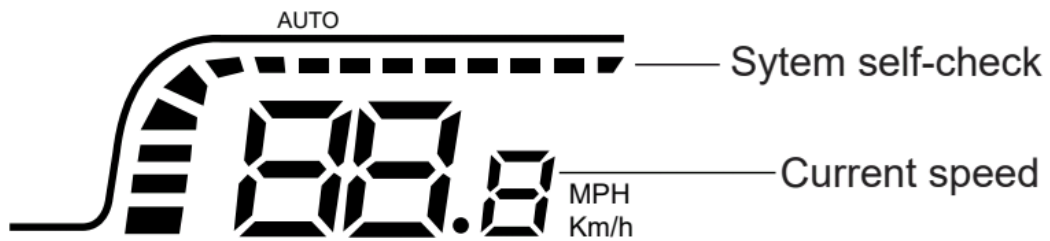

	Battery level		Sport mode
	Single Motor Mode		Drive mode
READY	Ready to start		ECO mode
	Cruise control		Top speed
	Headlight		Trip distance
	Temperature		



Display Content

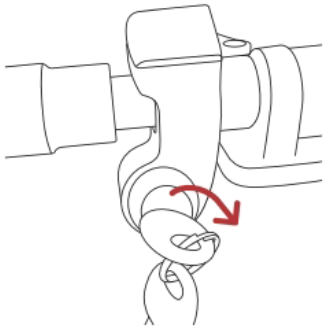

1. Turn the key of the ignition switch

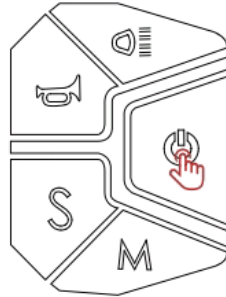

2. Press the power button to turn on the scooter



3. 3 speed levels:
10 km/h, 15 km/h, 25 km/h



5. Press Horn button and the display reads "P10" (non-zero start); press S button and the display reads "P11"(zero-start); press M button to return to P10

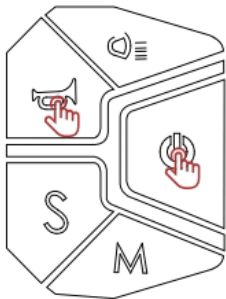

4. Press and hold Power and horn buttons for 5-8 seconds to enter mode setting interface



6. Press Horn button and the display reads P20 (cruise control off); press S to turn on cruise control; press M to return to P20





Note: After mode is set, wait about 5 seconds and the mode setting will be saved automatically and it will exit the interface.



7. Press Horn button and the display reads P30(low-speed mode); press S to switch to P31(high speed mode); press M to return to P30



8. Press the power button to save the settings to high speed mode: 15 km/h, 30 km/h, 45 km/h



Display Content

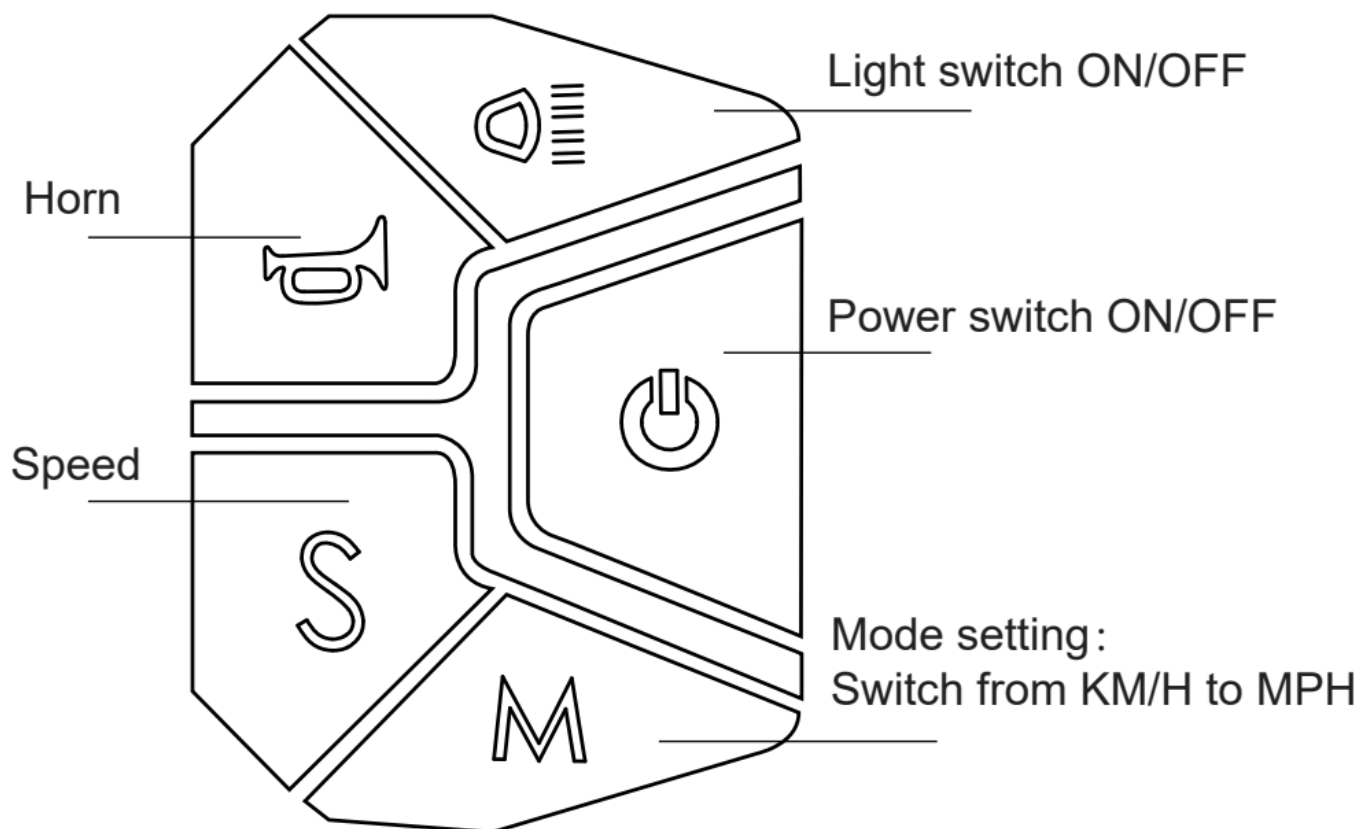

Power ON/OFF button :

Press and hold for 3S to power on / off.



Light switch :

Press the switch to turn on / off light.



Horn :

Press and hold to sound the horn.



Speed :

Click the speed switch button to increase speed.



Mode setting :

Switch from KM/H to MPH.



Screen



Battery Level Display:

6-bar battery level.



6 Bars:

90%~100% of battery level



5 Bars:

70%~90% of battery level



Charging prompt

when the battery runs out and the scooter slides to a natural stop due to inertia. So you have to charge it very soon. It is recommended not to drain the battery by 100%. Charge it before use.



READY:

After turning on the E-scooter, the word "READY" appears on the instrument display to remind rider to wear a helmet, knee pads, elbow pads, and abide by traffic regulations when riding.



Activate Cruise Control:

After activating cruise control, you can release the thumb throttle, the scooter moves at a uniform speed. After you press the brake to stop, press the throttle again, and the scooter returns to the initial state.



Headlight:

After the scooter is powered on, press the headlight switch button by clicking the multi-function switch. Symbols appear on the instrument display when all the lights are turned on.



Maximum Speed:

It shows the highest speed of the whole ride.



Current Speed:

The display shows the current speed during riding.



Trip distance:

Shows the travelled distance of a trip, and automatically resets to zero after the scooter is powered off.



E-SCOOTER APP



App Store

Download "Circooter" app from App Store (iPhone)/Google Play (Android) or scan the QR code to and install the app. Then connect your phone to the scooter.



1. Open the APP and enter the main page, Click Sign up

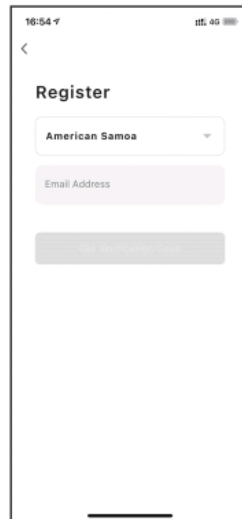

2. Select country and enter your email



3. Find the verification code sent by us in your mailbox, Fill in the verification code



4. Set a password for your account

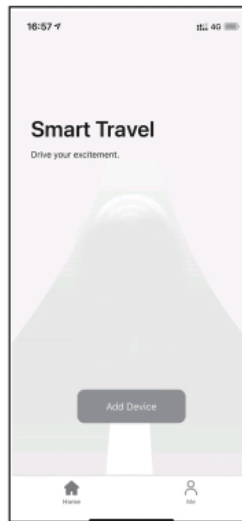

5. Account registration is complete, start your riding experience immediately



Assemble

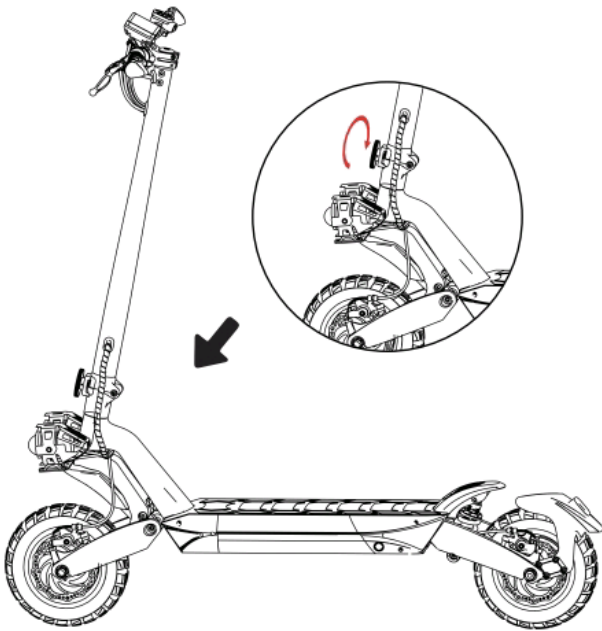

1. ①Lift up the scooter pole
②Rotate the folding button to the right until it is tightened and fixed

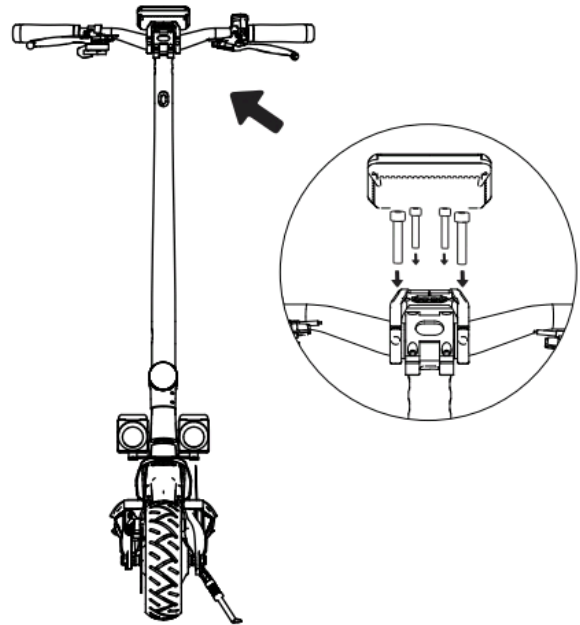

2. Insert the handlebar assembly into the fold large tube and lock the 4 screws.



Attention

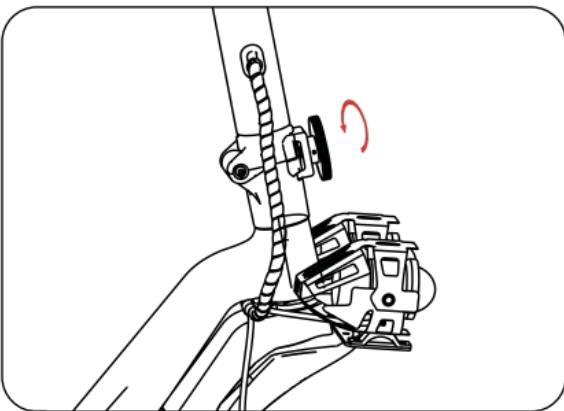

1. Turn the fold connector knob counterclockwise until the fold connector buckle no longer holds the connector.

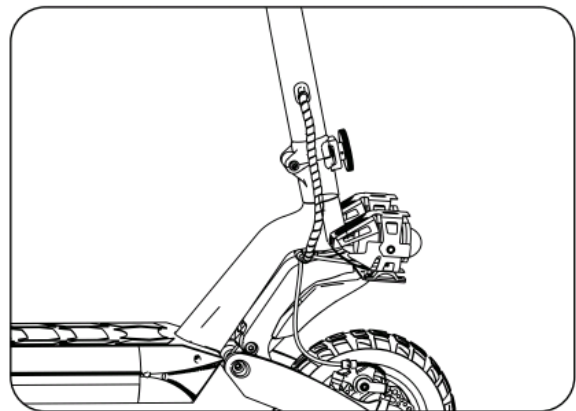

2. Fold the handlebars and tubes to the rear.



Riding Basics

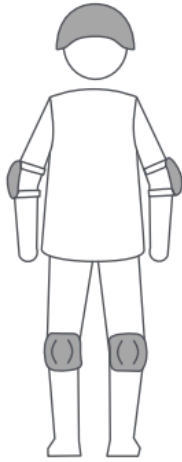

Wear a helmet, elbow pads, and knee pads in case of falls and injuries either you are a beginner learning to ride or you are a seasoned rider.



Turn the power on, and check the battery level indicator.



2 Stand with one foot on the deck and one foot on the ground. Scoot yourself with the foot on the ground.

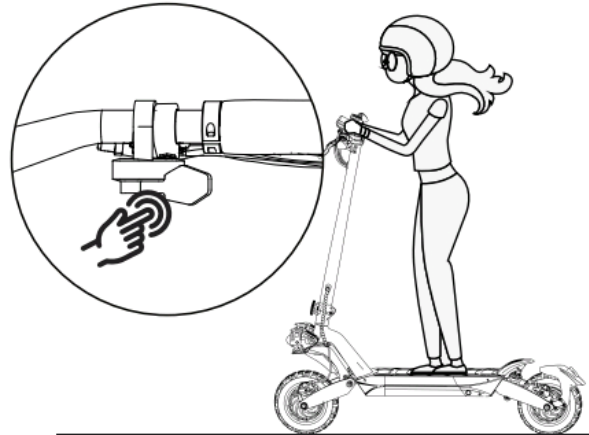

3 When the scooter starts to move forward, put both feet on the deck and press the accelerator. (The accelerator initiates once the speed exceeds 3 mph.)

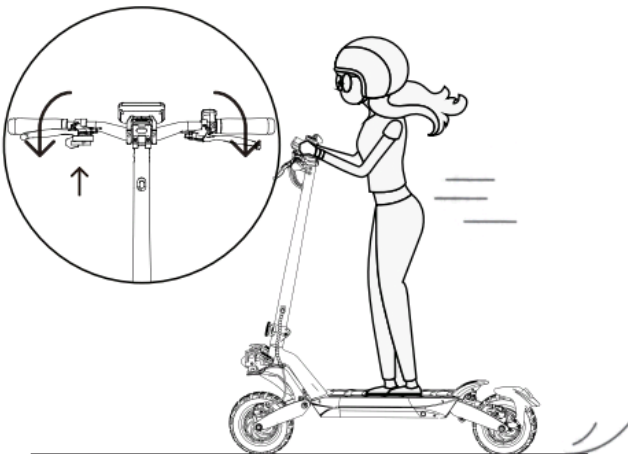

4 Release the accelerator and the kinetic energy recovery system (KERS) initiates automatically to brake slowly; And squeeze the brake lever for a sudden brake.

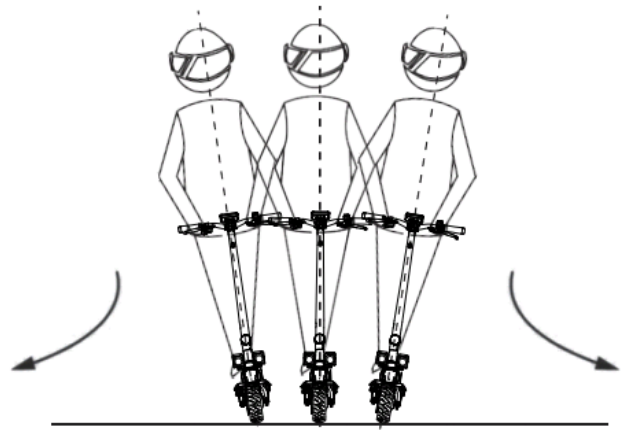

5 Tilt your body to the steering direction as you turn, and slowly turn the handlebar.



Riding Notice



 Do not ride in the heavy rain.



 Please keep a medium or low speed (5mph) when you ride through speed bumps, elevator door sills, bumpy roads or other uneven surfaces. Slightly bend your knee to better adjust mentioned surfaces.

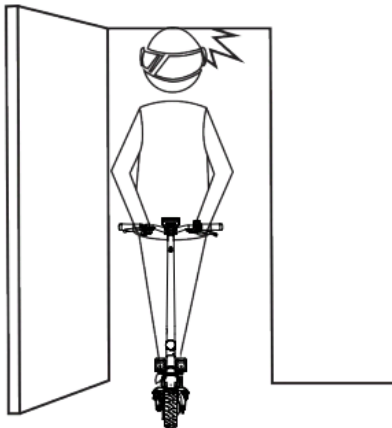

 Look out for doors, elevators and other overhead obstacles.



 Do not accelerate when you go downhill.



 Do not press the accelerator when you're walking alongside the scooter.



 Always steer clear of obstacles.



Riding Notice



 Do not hang heavy stuff on the handlebar.



 Keep both feet on the deck all time.



Dangerous Actions

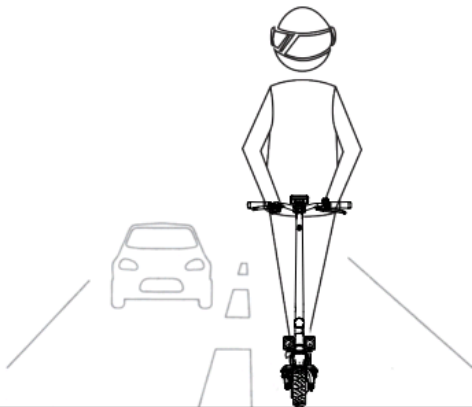

 Do not ride in traffic lanes or residential areas where vehicles and pedestrians are both allowed.

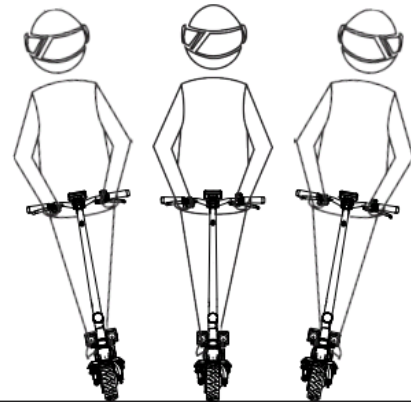

 Do not turn the handlebar violently during high-speed riding.



 Do not ride in a ponding that is higher than 2 INCH.



 No passengers are allowed, including children.



Dangerous Actions



⊘ Keep your feet off the rear mudguard.



⊘ Always keep your hands on the handlebar.



⊘ Do not touch the disc brake rotor.

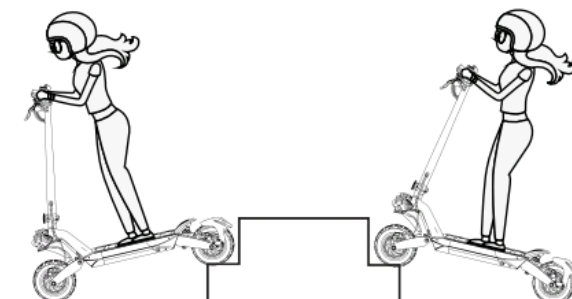

⊘ Do not try riding up or down stairs, or jumping over obstacles.



Charging

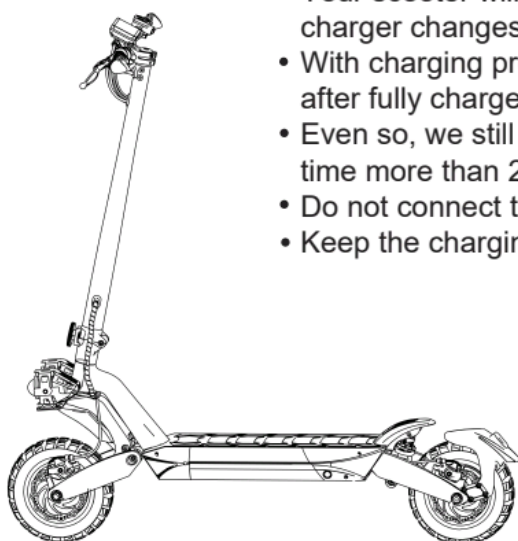

- Your scooter will be fully charged when the LED indicator on the charger changes to green from red.
- With charging protection, it will cut off charging automatically after fully charge.
- Even so, we still don't recommend charging your scooter for a long time more than 24 hours at one time.
- Do not connect the charger if the charging port is wet.
- Keep the charging port closed when not charging.

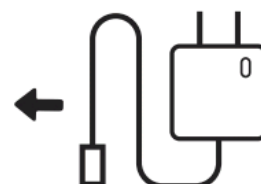



Disc Brake Adjustment

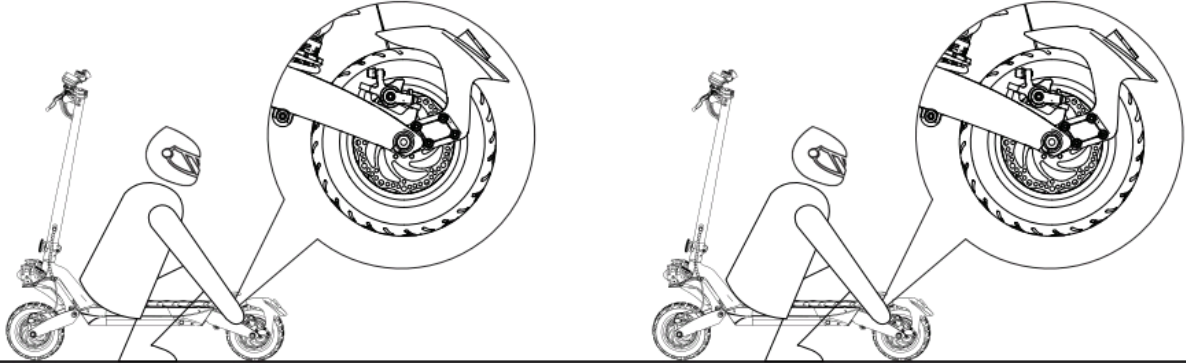

To adjust the disc brake sensitivity:

You need a hex wrench to remove the screws on the rocker.

- When the disc brake is too sensitive, rotate the disc brake rocker down a bit. Then, reinstall the screws back to the brake cable core to tighten.
 - When the disc brake cannot stop, rotate the disc brake rocker up a bit. Then, reinstall the screw back to the brake cable core to tighten.
- Notice: The disc brake may squeak when in use until it is broken in. This is normal and does not affect the brake's function or performance.

To remove the disc brake noise,

First make sure the scooter is turned off. For easier operating, we suggest you put the scooter on the desk.

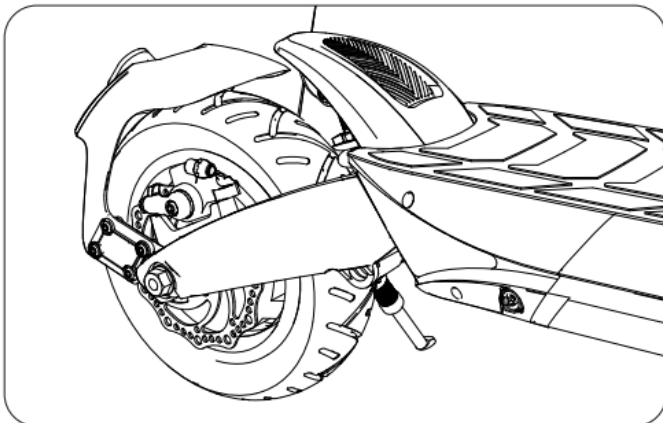

- Loosen two screws on the pump (not the screw on the rocker).
- Adjust the position of the disc brake pump to ensure that the brake disc is in the middle of the two brake pads.
- Keep the brake disc and brake pad not touching each other.
- Hold the disk brake pump in the desired position, then re-tighten the screws to the pump.



Daily Care and Maintenance

Cleaning and Storage

If you see stains on the scooter's body, wipe them off with a damp cloth. If you cannot scrub off the stain, put on some toothpaste, and brush them with a toothbrush, then wipe them off with a damp cloth.

Notes :

- Do not clean the scooter with alcohol, gasoline, kerosene, or other corrosive and volatile chemical solvents to prevent dire damage.
- Do not wash the deck with a high-pressure water spray. During cleaning, make sure that the scooter's turned off, the charging cable is unplugged, and the rubber flap is closed as water leakage may result in electric shock or other major problems. When the scooter is not in use, keep it indoors where it is dry and cool.
- Do not put it outdoors for a long time. Excessive sunlight, overheating, and over-cooling will shorten the battery pack's lifespan.

Battery Maintenance

- 1 Use original battery packs. Use of batteries of other models or brands may bring about safety issues;
- 2 Do not touch the contacts. Do not dismantle or puncture the casing. Keep the contacts away from metal objects to prevent short circuit which may result in battery damage or even injuries and deaths;
- 3 Use original power adapter to avoid potential damage or fire;
- 4 Mishandling of used batteries may do tremendous harm to the environment. To protect natural environment, please follow local regulations to properly dispose used batteries.
- 5 After every use, fully charge the battery to prolong its life span.

Storage and Disposal

- 1 Please try to store the scooter in a cool and dry place between 14°F and 104°F. In extremely humid environments the interior of the scooter may suffer condensation or even water accumulation, which may damage the battery rapidly. Devices are not intended for use at elevations greater than 2000 m above sea level. Prolonged Exposure to UV Rays, Rain and the Elements May Damage the Enclosure Materials, Store Indoors When Not in Use.
- 2 In daily use, try to recharge the scooter after completely exhausting the battery. If the battery level is low, charge it as soon as possible.
- 3 Please charge the scooter every other month to preserve the battery.



Limited Warranty Statement

30 DAY SATISFACTION GUARANTEED RETURN POLICY

If you are unsatisfied with your purchase, circooter's return policy allows you to return the product purchased on the Authorization channel within 30 days counting from the date of receipt of shipment, and request a refund from the Authorization channel for any reason.

Note: Express shipping cost is non-refundable.

For the return request, circooter is not responsible for lost packages due to the carrier, or products received that cannot be verified. Received products that have damage determined to have been caused by the end-user may be subject to denial of the return request.

TO QUALIFY FOR A REFUND, ALL THE FOLLOWING CONDITIONS MUST BE MET

- 1 A Return Merchandise Authorization (RMA) must be requested from circooter within 30 days from the date of receipt of shipment. To request an RMA, contact circooter Service Team at support@circooter.com.
- 2 The cost of return shipping will be borne by the customer.
- 3 For warranty service, please keep your receipt and/or invoice to validate proof of purchase.
- 4 Returned product must be in good physical condition (not physically broken or damaged).
- 5 All accessories originally included with your purchase must be included with your return.
- 6 If you return a product to circooter, (a) without an RMA from circooter (b) without all parts included in the original package, circooter retains the right to refuse delivery of such return.

LIMITED PRODUCT WARRANTY

circooter warrants the original purchaser that your circooter product shall be free from defects in materials and workmanship under normal use for a period aforementioned.

circooter does not warrant the operation of the product will be uninterrupted or error-free.

circooter is not responsible for damage arising from failure to follow instructions relating to the product's usage.

REMEDIES

If a hardware defect is found and a valid claim is received by circooter within the Warranty Period, circooter will, at its option and to the extent permitted by law, either (1) repair the product at no charge, using new or refurbished replacement parts or, (2) replace the product with a new or refurbished product. In the event of a defect, to the extent permitted by law, these are your sole and exclusive remedies. Shipping and handling charges may apply except where prohibited by applicable law. This Limited Warranty is valid only in the jurisdictions where the products are sold by support@circooter.com, and is valid to the extent permitted by the applicable laws of such jurisdictions.

Any replacement hardware product will be warranted for the remainder of the original warranty period or thirty (30) days, whichever is longer, or for any additional period of time that may be applicable in your jurisdiction.

HOW TO OBTAIN WARRANTY SERVICE

A Warranty Service Order must be requested from circooter within Warranty Period from the date of receipt of shipment. To request a Warranty Service Order, contact circooter Service Team support@circooter.com.

To obtain warranty service, you must deliver the product, in either its original packaging or packaging providing an equal degree of protection, to the address specified by circooter. In accordance with applicable law, circooter may require the customer to furnish proof of purchase details and/or comply with registration requirements before receiving warranty service. period or thirty (30) days, whichever is longer, or for any additional period of time that may be applicable in your jurisdiction.



Error Code

Error code	Reason	Maintenance and treatment
4	Short-circuit fault	Check if there is a wrong wire connection or if there is a short circuit in the installation, remove the short circuit or replace the controller
9	Motor communication fault	Check whether the connection line between the controller and the main controller is well connected.
10	Dashboard communication fault	Check whether the instrument panel and controller assembly cables are normal, turn off, remove the assembly line interface, check the plug-in for slanting and loosening, and insert again after processing. Power on, replace instrument or controller.
11	Motor current fault	Check the motor and the phase line portion of the controller
14	Throttle fault	Check whether the accelerator is completely reset, check whether the accelerator and connection line are normal, can disconnect the acceleration connection line, and restart to exclude exceptions.
15	E-Brake fault	Check whether the brake handle is completely reset, can pull out the electronic brake cable, restart, troubleshooting.
16	Motor communication fault	Start-up fault, check whether the motor Hall wiring is normal, shut-off, pull out the assembly line interface and check whether the plug-in is crooked, or bad contact, correct, restart and troubleshooting
21	BMS communication fault	
50	Battery line fault	The voltage of the main line is too high, and the fault is turned on. You should check whether the battery voltage is normal and faulty during cycling. You should replace the battery or controller to eliminate the problem
53	Controller fault	Beyond the system load, restart, start up failure, the controller should be replaced to eliminate the problem
55	Controller high temperature alarm	The controller temperature is too high, static let the car to cool and then restart. If the startup fails, replace the controller to eliminate the problem.



FAQs

1 What if the E-Scooter comes arrived with missing accessories or broken parts?

A: Please take a photo and send to circooter Support Team by sending email: And circooter Support Team will reply to you soon and send correct accessory or part replacement.

2 Is the tire replaceable and how to replace the tire?

A: Yes, the tire is replaceable. Please contact circooter support team for more information or search the video "How to replace the offroad tire" in YouTube instead.

3 What if the rear disc brake of the scooter doesn't work well?

A: You may please contact us for instructions of brake adjusting, or search "How to adjust rear brake of scooter" in YouTube for tutorial video as well.

4 What if the rear disc brake of the scooter doesn't work well?

A: It usually means your disc brake tilts to cause friction noise. Please see Disc Brake Adjustment page. If you still have problem, please contact us for help.

5 Why does the display read error code?

A: If you see any error code above, Please contact circooter Support Team to remove the error code.



Contact Us

Contact us if you experience issues relating to riding, maintenance and safety, or errors/faults with your Circooter electric scooter.

 E-mail Service: hello@circooter.com

 www.Circooter.com

 Facebook: [@CIRCOOTER](https://www.facebook.com/CIRCOOTER)

 ins: Circooter

 Youtube: Circooter