

# Sylvox

## OUTDOOR TV

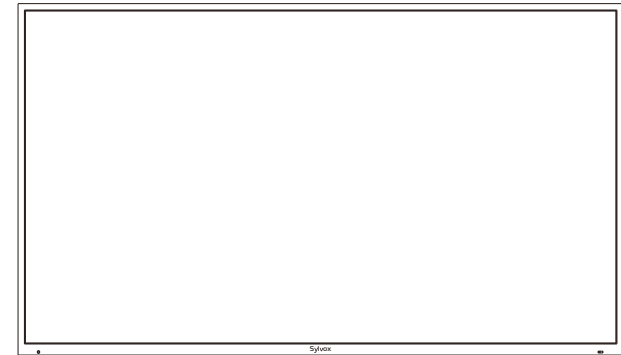

**USER'S MANUAL**

Note: The product and illustrations in this user's manual is only for explanation purposes and may vary depending on model.

## USER'S MANUAL

## BEDIENUNGSANLEITUNG

## MANUEL DE L'UTILISATEUR

## MANUALE D'UTENTE

## MANUAL DE USUARIO

## General Information

To avoid damaging the television set please observe the following safety instructions during setup and use.

Cleaning the television set	Before cleaning, disconnect the television set. Use only a soft damp cloth or a special cleaning product for flat-screens.
LED Display	Too much pressure on the screen can damage the television set.
Heat/damp/humidity	The television set should not be exposed to high temperatures (radiators, open fire). The television set should not be used in areas with high humidity.
Condensation	If moved from a cool area to one with a higher temperature, the television set should be left for at least an hour before plugging it in. A rapid change of temperature can lead to the formation of condensation in the television set itself. This can lead to damage if the television set is in use.
Air Circulation	To prevent overheating of the television set the ventilation slots at the rear should always be clear.
Small Objects	It is important to ensure that no small objects or liquids enter the television set. They can cause damage or even fire.
Liquids/Candles	Do not place anything holding a liquid or any candles on the television set.
Crushing	Take care to avoid crushing fingers or other objects when turning the television set in any direction.
Electric Supply	Use the television set only with the voltage indicated in the specifications. Ensure that there is easy access to the plug and that the television set can always be disconnected from the electricity supply. Do not disconnect the television set by pulling the power cable. Always take hold of the plug. The power cable must not be kinked or placed over sharp edges.
Moving the Television Set	When moving the television set, hold only the casing.
Repairs/Accessories	Repairs and servicing must be undertaken only by authorised and trained personnel.
	In accordance with the Batteries Regulation, batteries are to be disposed of only in containers provided for this purpose.



In extreme weather (storms, lightning) and long inactivity periods (going on holiday) disconnect the TV set from the mains. The mains plug is used to disconnect TV set from the mains and therefore it must remain readily operable. If the TV set is not disconnected electrically from the mains, the device will still draw power for all situations even if the TV is in standby mode or switched off.

**IMPORTANT - Please read these instructions fully before installing or operating**  
**WARNING: Never let people (including children) with reduced physical, sensory or mental capabilities or lack of experience and / or knowledge use electrical devices unsupervised.**

- The TV set is intended for Outdoor and similar general use but may also be used in public places.
- For ventilation purposes, leave at least 5cm of free space around the TV.
- The ventilation should not be impeded by covering or blocking the ventilation openings with items, such as newspapers, table-cloths, curtains, etc.
- The power cord plug should be easily accessible. Do not place the TV, furniture, etc. on
- A damaged power cord/plug can cause fire or give you an electric shock. Handle the power cord by the plug, do not unplug the TV by pulling the power cord. Never touch the power cord/plug with wet hands as this could cause a short circuit or electric shock. Never make a knot in the power cord or tie it with other cords. When damaged it must be replaced, this should only be done by qualified personnel.
- Do not expose the TV to dripping or splashing of liquids and do not place objects filled with liquids, such as vases, cups, etc. on or over the TV (e.g., on shelves above the unit).
- Do not do not place open flames such as lit candles on the top of or near the TV.
- Do not place any heat sources such as electric heaters, radiators, etc. near the TV set.
- Do not place the TV on the floor and inclined surfaces.
- To avoid danger of suffocation, keep plastic bags out of the reach of the babies, children and domestic animals.
- Do not dispose of the batteries in fire or with hazardous or flammable materials.
- Warning: Batteries must not be exposed to excessive heat such as sunshine, fire or the like.
- If you think batteries might have been swallowed or placed inside any part of the body, seek immediate medical attention.

#### WARNING

Never place a television set in unstable or inclined locations. A television set may fall, causing serious personal injury or death. Many injuries, particularly to children, can be avoided by taking simple precautions such as, Educating children about the dangers of climbing on furniture to reach the television set or its controls.

#### WALL MOUNTING WARNINGS

Read the instructions before mounting your TV on the wall.

The wall mount kit is optional.

Do not install the TV on a ceiling or on an inclined wall.

Use the specified wall mounting screws and other accessories.

Tighten the wall mounting screws firmly to prevent the TV from fall. Do not over-tighten the screws.

#### WARNING

This is not a recessed installable TV, Do not insert TV into the wall.

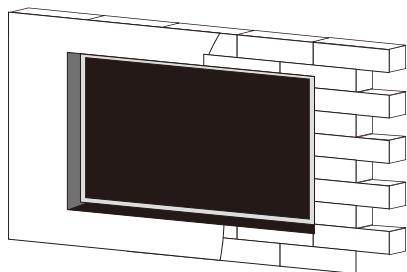

## Accessories

Please make sure the following items are included with your TV.  
 If any items are missing, Please contact us.



Remote Control



Warranty Card

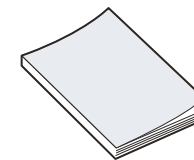

User's manual

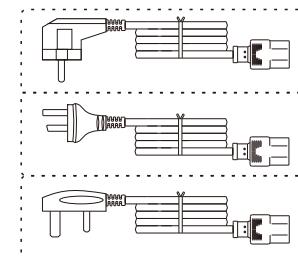

Euro Schuko plug power cord  
 or AUS plug power cord  
 or UK power cord

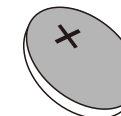

Batteries (CR2032)



Screws BM8X14MM

(Matched with Sylvox Full Motion Cantilever Mount)



Screws BM8X28MM & Gasket

(Matched with Fixed Wall Mount)

# Content

<b>TV Specification</b> .....	1
<b>Installation</b> .....	2~4
<b>Overview</b> .....	5
<b>Remote-Control unit</b> .....	6~7
<b>Boot Wizard</b> .....	8-12
<b>Inputs</b> .....	13
<b>Main Menu</b>	
Channel bar .....	14
Channel settings .....	15-18
Power .....	19-20
Record bar .....	21
Settings .....	21
Network settings .....	22
Accounts & sign in .....	22
Apps .....	23
Device Preferences .....	23
Remotes & Accessories settings .....	24-25
FileManager .....	26
Photo .....	27
Music .....	27-28
Movie .....	28
<b>Troubleshooting</b> .....	29-30
<b>Warranty</b> .....	30

# TV Specification

Screen size	43"
Display Type	TFT LED
Resolution	3840 X 2160
Aspect Ratio	16:9
Alimentation	AC 100-240V 50/60Hz
Audio Output	L/R 10W X 2
Dimensions	97.56 x 57.51 x 8.75 cm
Operating Temperature	-22° to 122° F (-30° to 50°C)

Screen size	55"
Display Type	TFT LED
Resolution	3840 X 2160
Aspect Ratio	16:9
Alimentation	AC 100-240V 50/60Hz
Audio Output	L/R 10W X 2
Dimensions	124.40 x 72.63 x 8.75 cm
Operating Temperature	-22° to 122° F (-30° to 50°C)

Screen size	65"
Display Type	TFT LED
Resolution	3840 X 2160
Aspect Ratio	16:9
Alimentation	AC 100-240V 50/60Hz
Audio Output	L/R 10W X 2
Dimensions	146.33 x 84.96 x 8.75 cm
Operating Temperature	-22° to 122° F (-30° to 50°C)

Screen size	75"
Display Type	TFT LED
Resolution	3840 X 2160
Aspect Ratio	16:9
Alimentation	AC 100-240V 50/60Hz
Audio Output	L/R 10W X 2
Dimensions	168.10 x 97.40 x 8.75 cm
Operating Temperature	-22° to 122° F (-30° to 50°C)

**Note:**

Design and specification modification maybe made at any time without prior notice, all data and dimensions are approximations.

# Installation

## Fixed Wall Mount



## Sylvox Full Motion Cantilever Mount

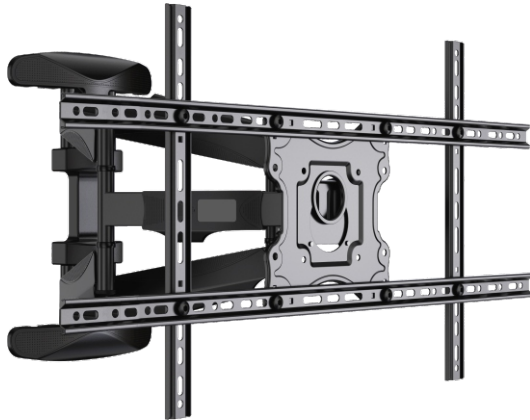

Screen size  
43"/55"/65"/75"



Capacity  
50Kg



VESA  
700 x 400mm

**Warning - Please read before installation**  
**(Mounting Brackets are not supplied with TV)**

Please thoroughly read instructions before attempting installation The only suitable for the 43"-75"Outdoor TVs.

We advise that 2 people install the screen due to the heavy load of the screens.

Please be sure the mounting surface is strong enough to hold the weight of the screen.

# Installation

## Step1-Mounting Bracket to Wall

Fix the horizontal bracket into wall with screws.

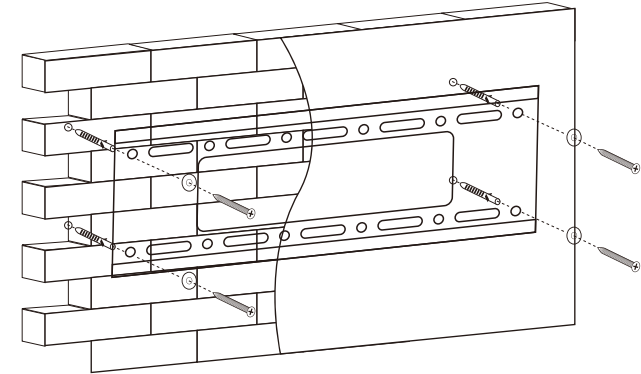

## Step2-Mounting bracket to TV

Fix the vertical bracket on the back of TV with screws(M8).

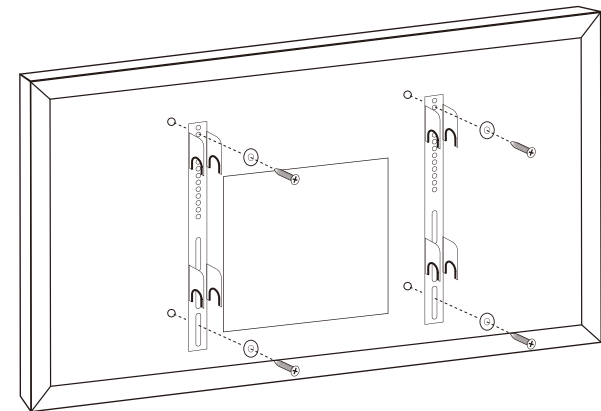

## Installation

Step 3—Mounting TV to Bracket  
Attach TV with brackets on wall.

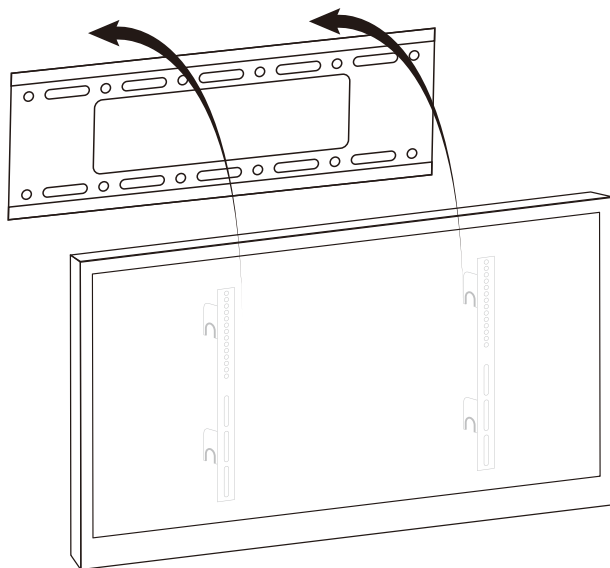

VESA Standard	Dimensions
	43": 400 x 200 mm
	55": 400 x 200 mm
	65": 400 x 400 mm
	75": 600 x 400 mm

## Overview

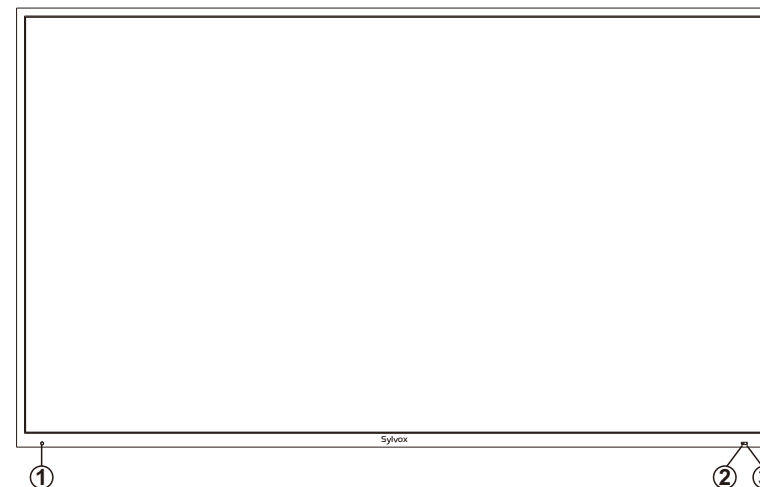

- ① Auto-brightness control sensor (1500cd/m<sup>2</sup> Series only)  
Automatically adjust the screen brightness according to the ambient light.
- ② REMOTE CONTROL SENSOR
- ③ POWER INDICATOR  
Green: In power on mode.  
Red: In standby mode.

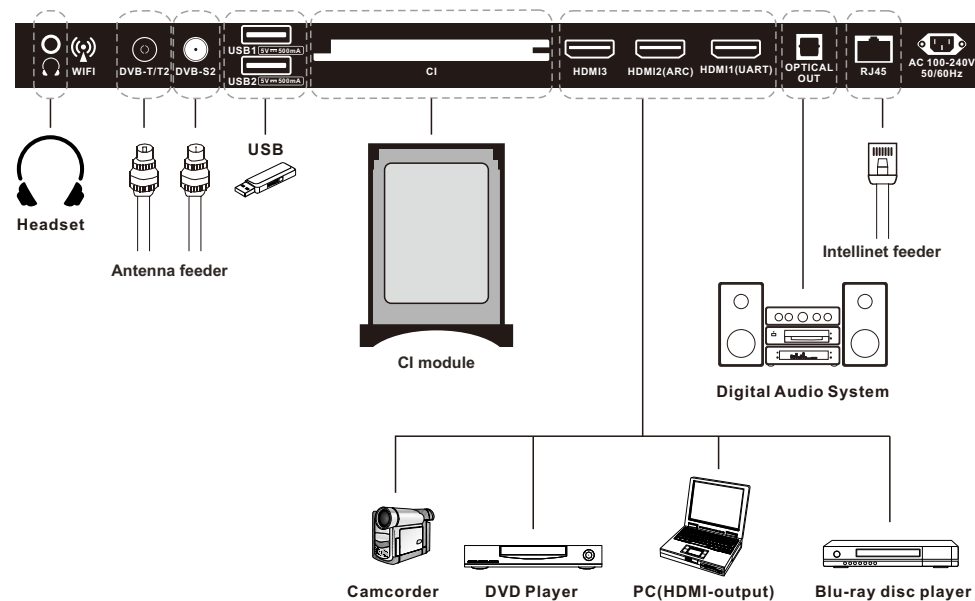

# Remote-Control unit



No.	Button	Description
1	POWER	Set your TV to power on or standby mode.
2	P.MODE	Select the picture mode.
3	S.MODE	Select the sound mode.
4	MUTE	Press to mute the sound. Press again to regain sound.
5	USB	Press this button to enter the USB channel.
6	AUDIO	Press to display the language of the audio in DTV.
7	FAV	Selects favorite channels.
8	EPG	Press to display EPG (Electronic Program information).
9	DISPLAY	Press this button to display the information on current input.
10	SOURCE	Press this button to display the input source.
11	MENU	Allows you to navigate on the screen menus (OSD).
12	EXIT	Exit from the current menu or sub-menu. Press twice to enter HOME.
13	◀▶▲▼	Allows you to navigate the on-screen menus and adjust the system settings to your preference.
14	HOME	Android home screen.
15	DEL	Android delete.
16	🖱️	Android mouse.
17	REC.MENU	Press to switch to REC.MENU immediately (DTV only).
18	CH+/-	Press these two buttons to change channels up/down.
19	VOL+/-	Press these two buttons to increase/decrease the volume.
20	0-9	Press 0-9 to select a TV channel directly. The channel will change after 2 seconds. Applicable for enter page number in TELETEXT mode.
21	SLEEP	Set the time for the TV to turn off automatically.
22	CH.LIST	Channel list button.
23	R (DELETE)	Delete function button.
24	G (RENAME)	Rename function button.
25	Y (MOVE)	Move function button.
26	B (SKIP)	Skip function button. Open and close the mouse.
27	TV/RADIO	Press to switch between DTV and radio programs
28	REVEAL	Shows hidden words or pages by Teletext.
29	TEXT	Switch on/off of Teletext window.
30	REC/●	Press to record the program immediately.
31	INDEX	Returns to Index page by Teletext.
32	T-SHIFT	Press to switch to TIME SHIFT mode immediately.
33	CANCEL	Switches the Teletext window to the background; only the current page is not visible.

# Boot Wizard

The following language selection menu is displayed when the system is turned on for the first time.

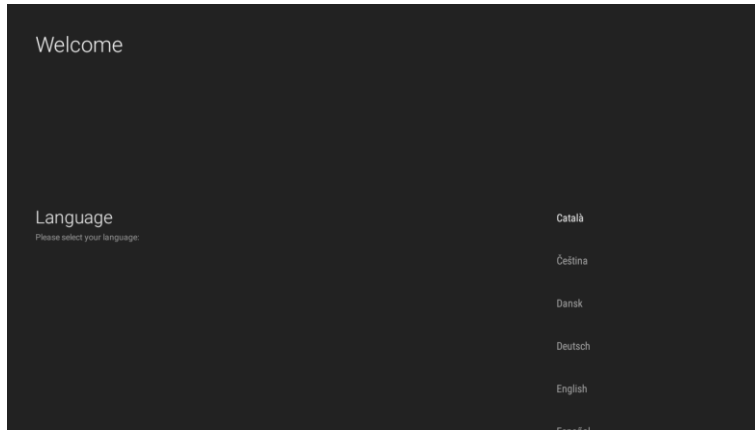

Enter the country selection interface.

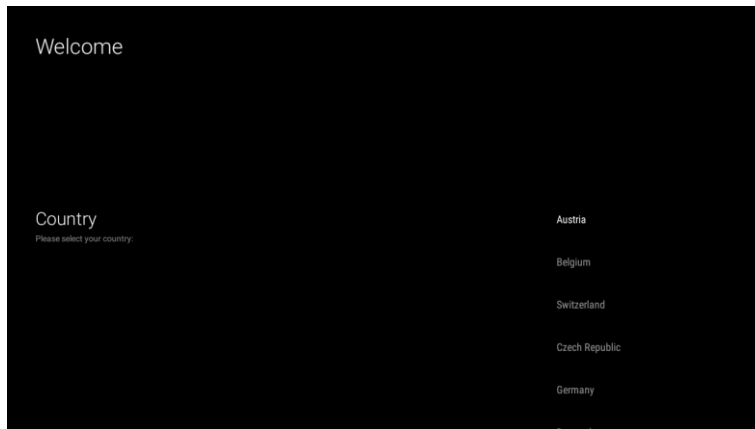

The following interface is displayed after country selection.

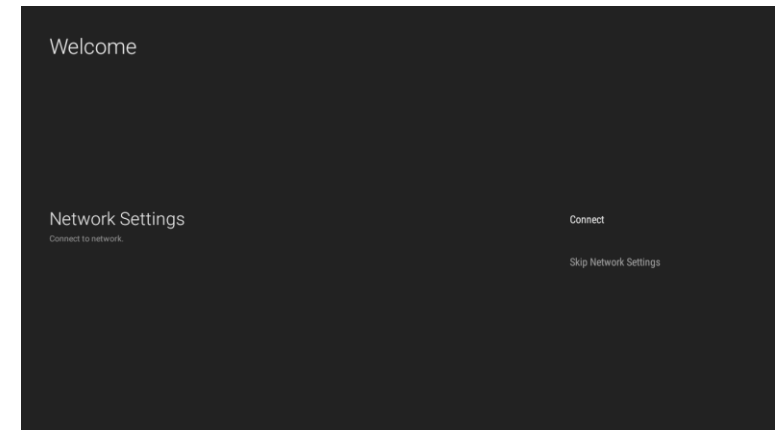

Choose "Connect" to set network.

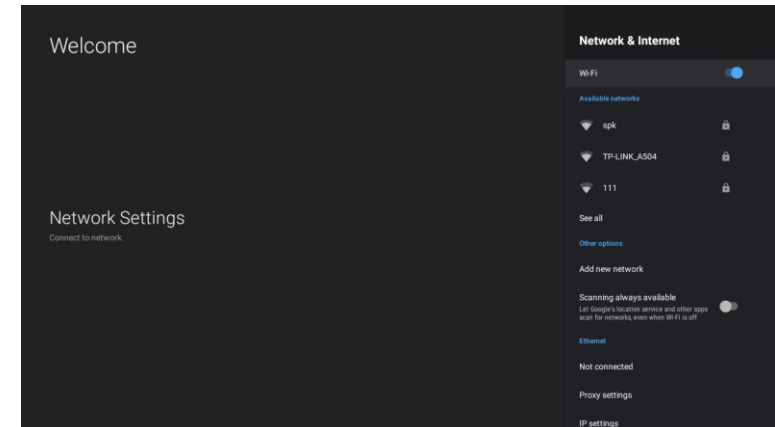

Enter the password setting interface after network setting or choosing "Skip Network Settings".

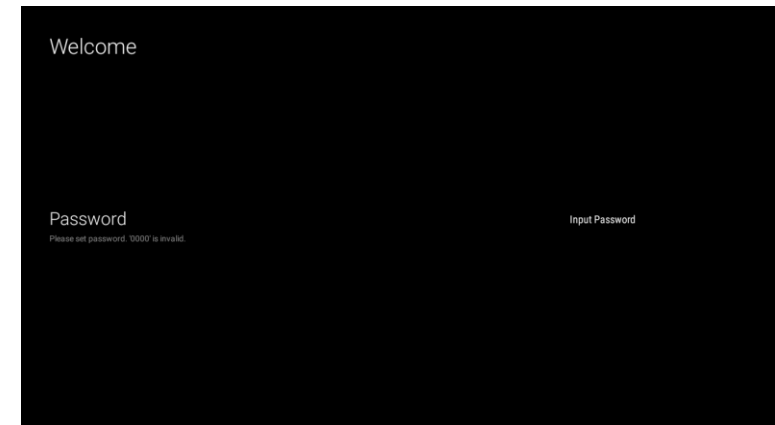



Enter the password input interface.

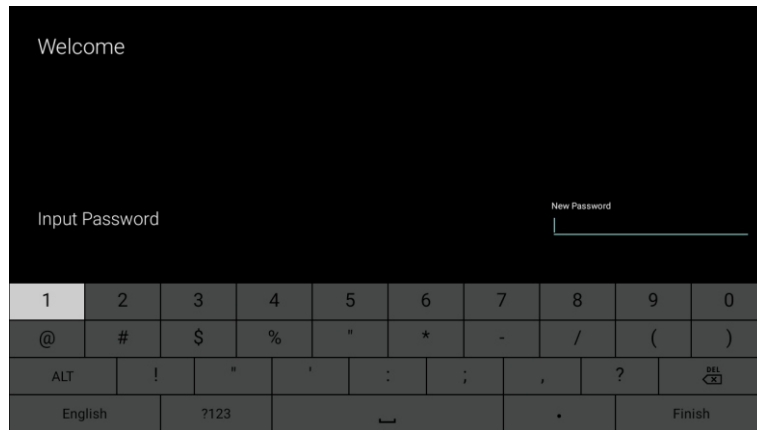

Enter the confirmation password interface. The user needs to enter the password again for confirmation.

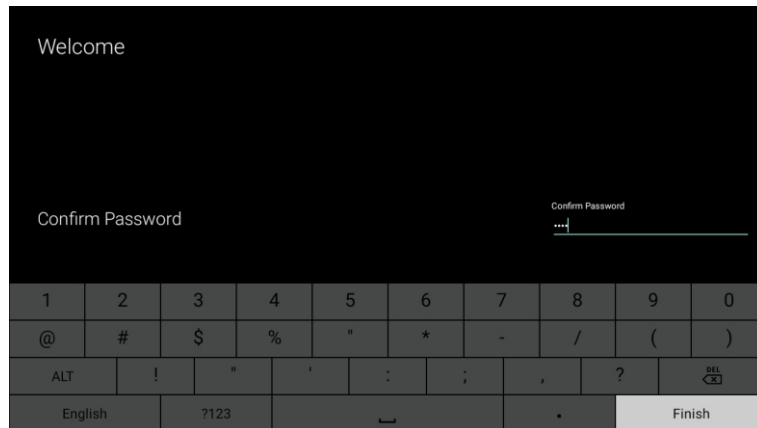

Enter the TV mode selection interface.

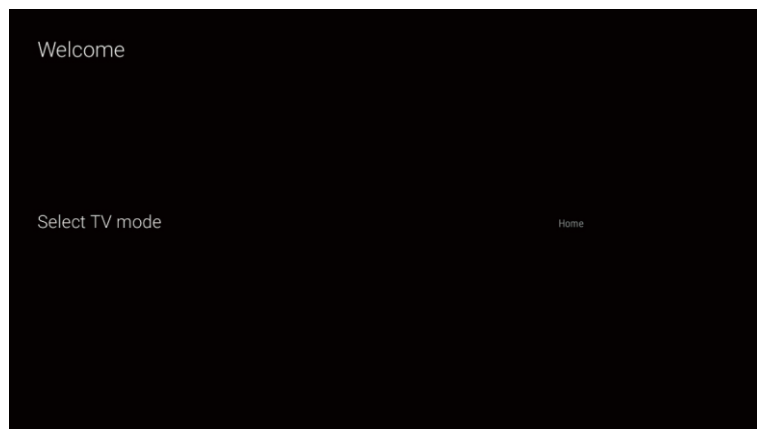

Enter the search type selection interface.

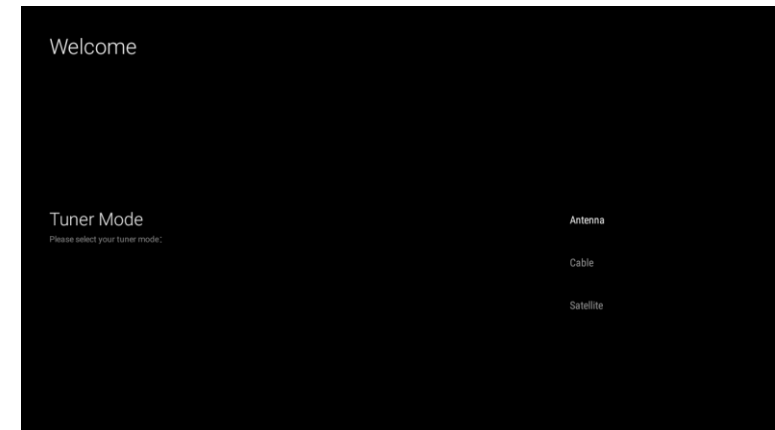

Enter the channel scan selection interface.

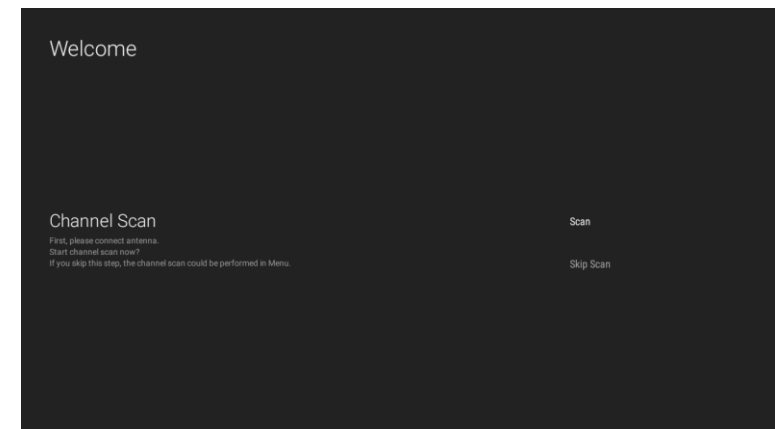

Enter the search interface after choosing "Scan".

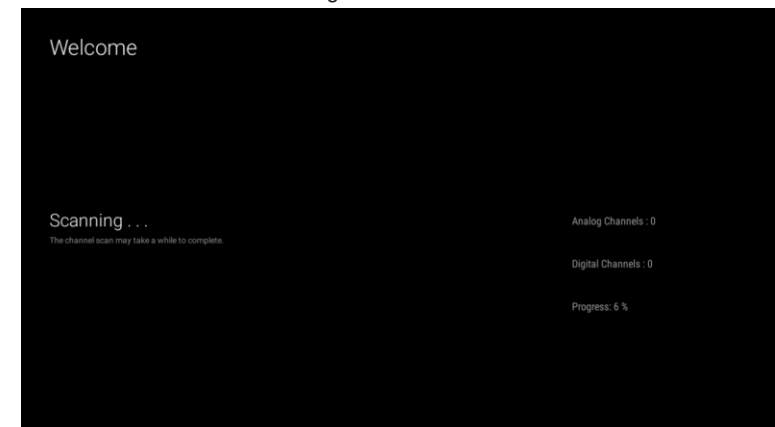

The boot wizard is set up.

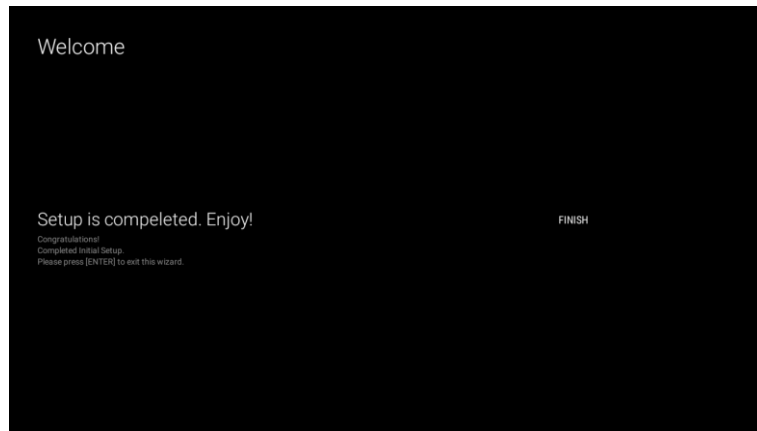

Enter the disclaimer interface, click accept to enter the TV interface.

If the TV mode is selected as home, you can enter the home interface after completing the wizard:

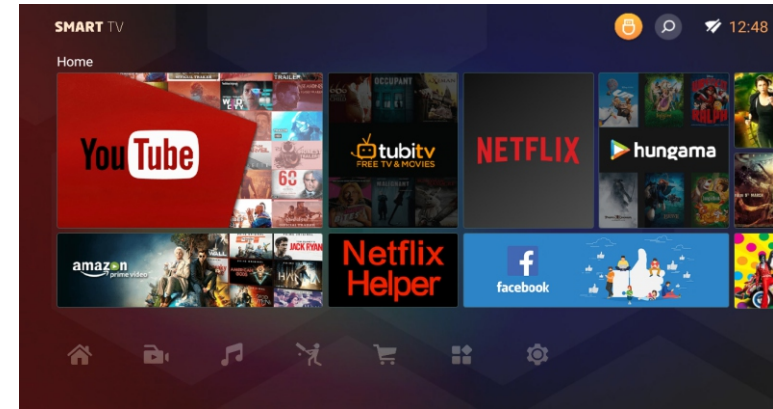

Otherwise, it will enter the play program interface:

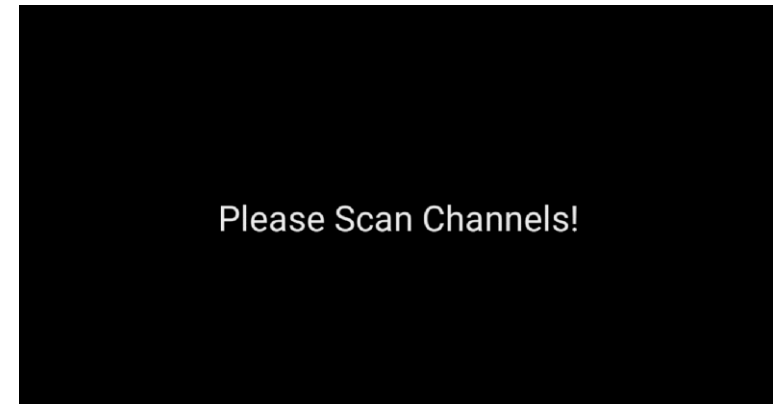

## Inputs

Press the [SOURCE] key to display the input source menu.

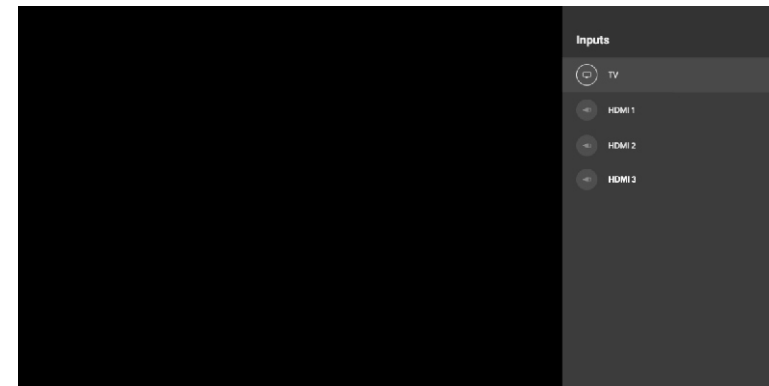

Press up/down key to select input source, then press OK button to enter.

# Main Menu

Press the [MENU] key to display the main menu. The main menu is divided into three columns, channel bar, toolbar, and Record bar.

## Channel bar

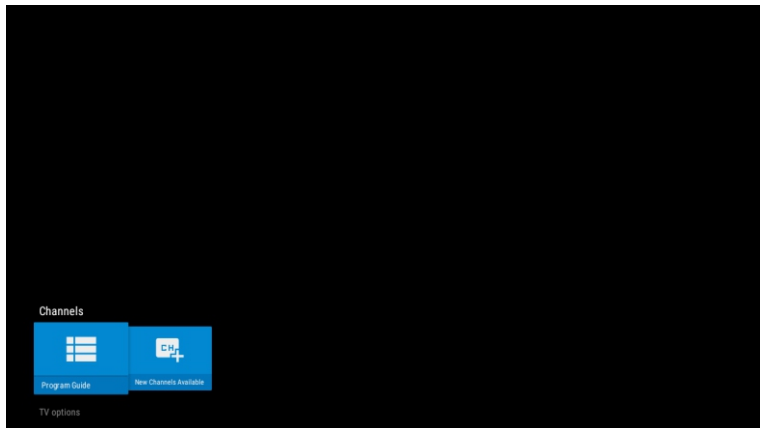

Program guide allows users to view program list information, including viewing detailed information such as channel programs and filtering operations on programs. New channels Available for users to search for channels.

## Tool bar

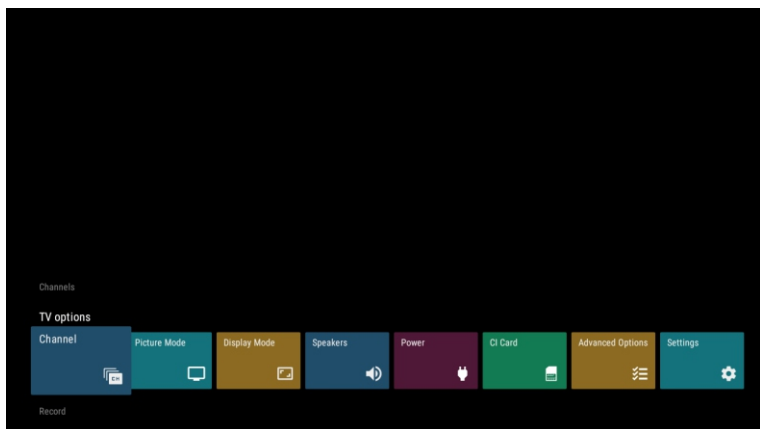

# Channel settings

Click the Channel option to enter the channel interface, as shown below:

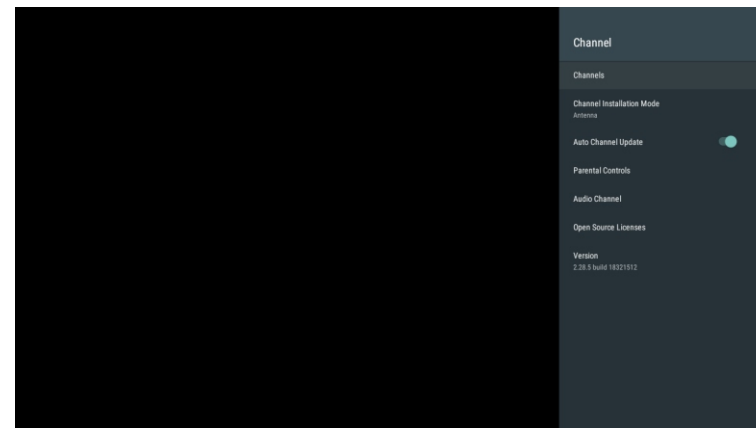

## Channels

The Channels option mainly provides the user's channel configuration and channel program list information.

## Channel Installation Mode

Antenna/Cable/Preferred Satellite/General Satellite Allows the user to select a channel mode.

## Auto Channel Update

On->Off.

## Parental Controls

Allows users to encrypt some channels.

## Audio Language

English/German/...Select the audio language.

## Audio Language 2nd

English/German/...Select the second audio language.

## Open Source Licenses

Press OK button display Licenses information.

## Version

The version information.

Clicking on Channels will jump to the following interface:

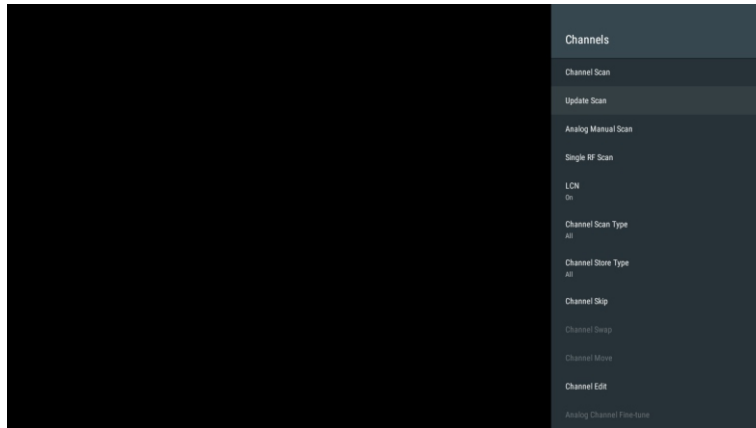

#### Channel Scan

Press Ok button to scan channels.

#### Update Scan

Press Ok button to scan channels.

#### Analog Manual Scan

Tuning the Analogue channel by you.

#### Single RF Scan

Scan Single RF channels.(Digital Only).

#### LCN

Off/On/Default.

#### Channel Scan Type

All/Only Encrypted Channels/Only Free Channels.

#### Channel Store Type

All/Only Digital Channels/Only Radio Channels.

#### Channel Skip

The selected programme will be skipped in channel list.

#### Channel Swap

Swap the selected two programme sin channel list.

#### Channel Move

Move the selected programme in channel list.

#### Channel Edit

Edit the programme tuned.

#### Analog Channel Fine-tune

#### Clear Channel List

The channel list will be empty.

Clicking on Channel Scan will jump to the following interface:

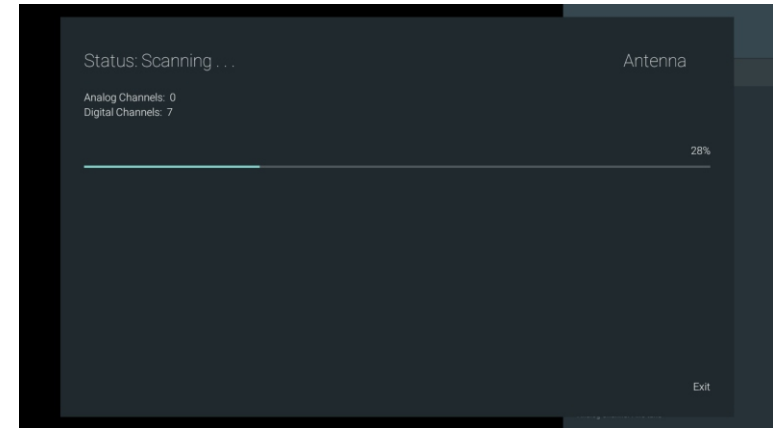

#### Status

Scanning.../Scan Cancelled (press Exit button)/Scan Completed.

#### Analog Channels

Show the numbers of Analog Channels .

#### Digital Channels

Show the numbers of Digital Channels.

Clicking on Analog Manual Scan will jump to the following interface:

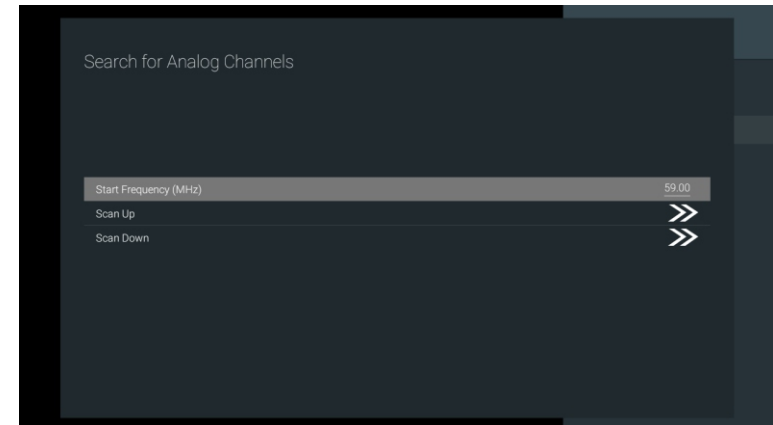

#### Start Frequency(MHZ)

Set the start frequency.

#### Scan up

Scan Frequency higher than the Start Frequency.

#### Scan Down

Scan Frequency lower than the Start Frequency.

Clicking on Parental Controls and inputting the correct PIN will jump to the following interface:

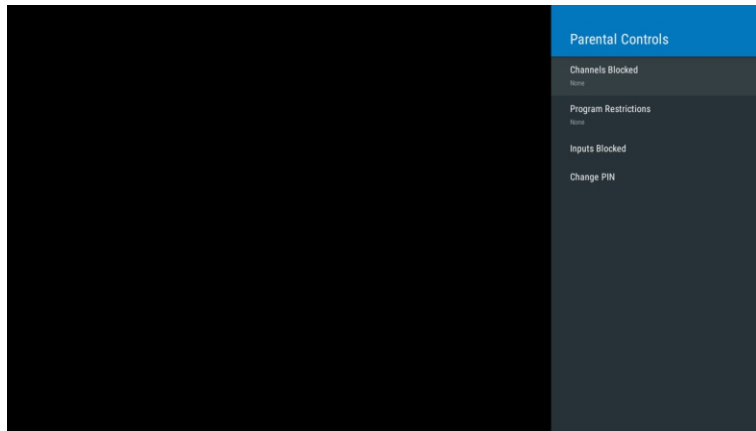

#### Channels Blocked

Block the selected programme. If select "Block All" will block all programmes.

#### Program Restrictions

#### Inputs Blocked

TV/Composite/HDMI1/HDMI2, Block the selected input source.

#### Change PIN

First enter the current PIN, then enter the new PIN, at last confirm your PIN.

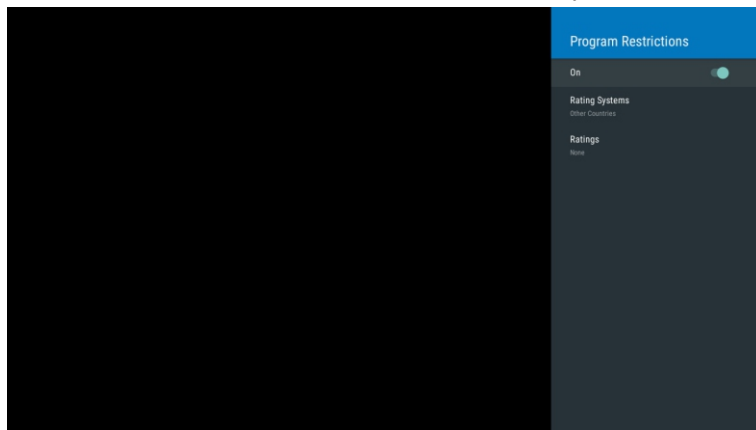

## Power

Clicking on Power will jump to the following interface:

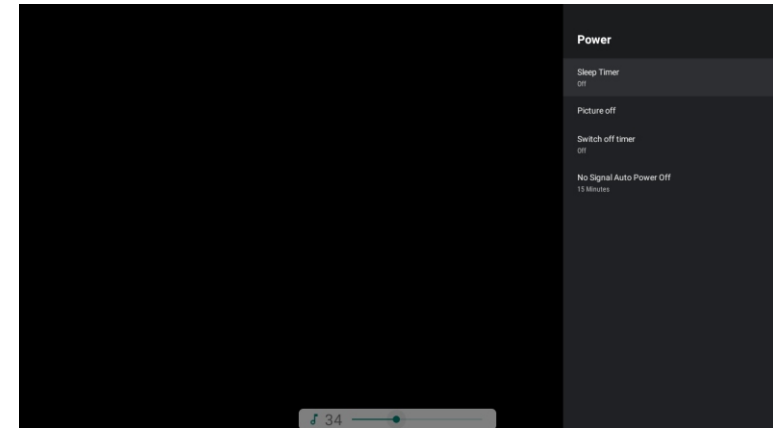

#### Sleep Timer

Off/10Minutes/20Minutes/30Minutes/40Minutes/50Minutes/60Minutes/90Minutes/120Minutes, Select the time you want TV close automatically.

#### Picture off

Press OK button picture will disappear, then press any key picture will display again.

#### Switch off timer

Off/30Minutes/60Minutes/90Minutes/120Minutes/150Minutes/180Minutes/210Minutes/240Minutes.

#### No Signal Auto Power Off

Off/5Minutes/10Minutes/15Minutes/30Minutes/60Minutes, Select the time you want TV close automatically when no signal.

## Advanced Options

Clicking on Advanced Options will jump to the following interface:

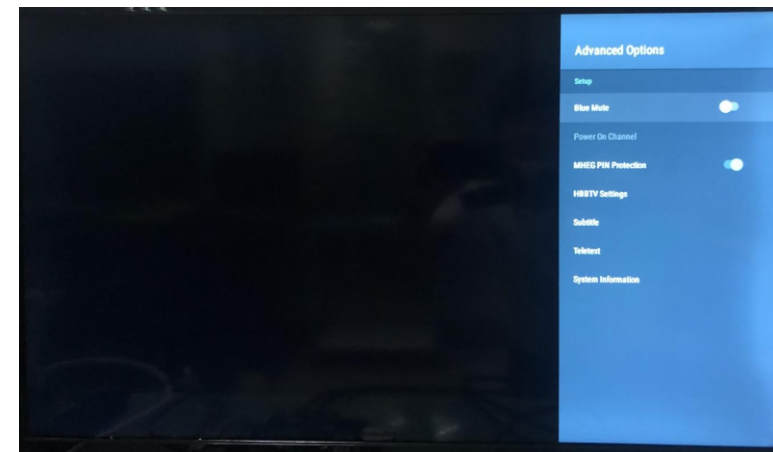

Clicking on Subtitle will jump to the following interface:

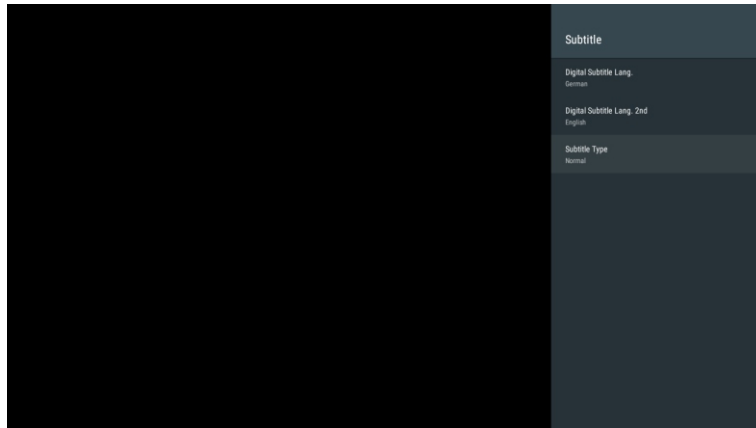

#### Digital Subtitle Lang

English/French/...Select the subtitle language.

#### Digital Subtitle Lang.2nd

English/French/...Select the the second subtitle language.

#### Subtitle Type

Normal/Hearing Impaired Select Subtitle Type.

Clicking on Teletext will jump to the following interface:

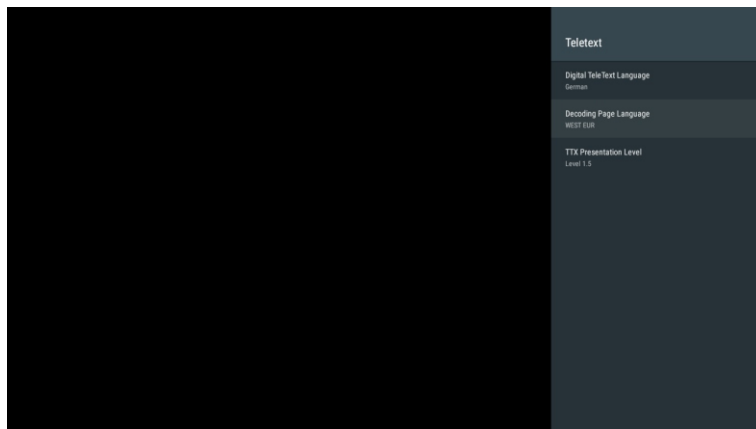

#### Digital Teletext Language

English/French/...Select the Teletext language.

#### Decoding Page Language

WEST EUR/EAST EUR/...Select the the decoding page language.

#### TTX Presentation Level

Level 1.5.

## Record bar

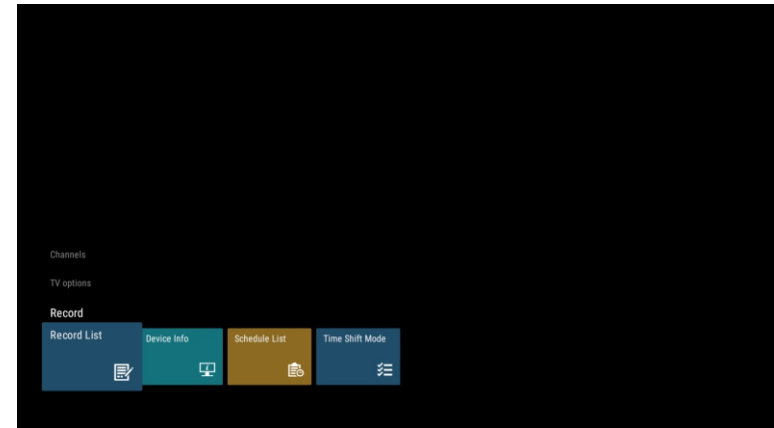

#### Record List

Look over and manage user's burned file list.

#### Device Info

Look over device details.

#### Schedule List

Timetable list for viewing, adding and deleting users.

#### Time Shift Mode

Time shift switch, users need to turn on time shift mode to use time shift function.

## Settings

Click the settings icon on the home page and the settings page will appear, as shown below:

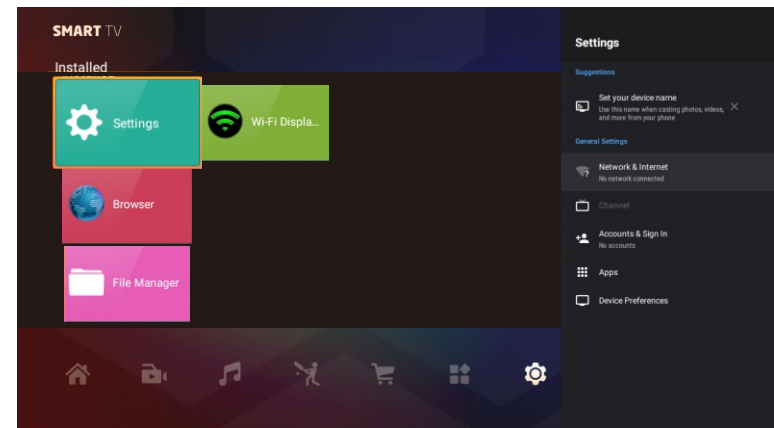

## Network settings

Click the network & Internet option to enter the network settings page as shown below:

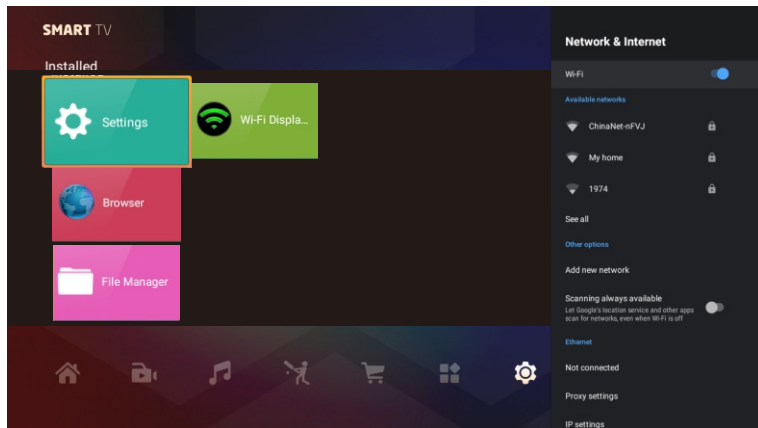

## Accounts & sign in

Click the “Accounts & sign in” option will jump to the following interface: Users can set your account(add email address) and sign in.

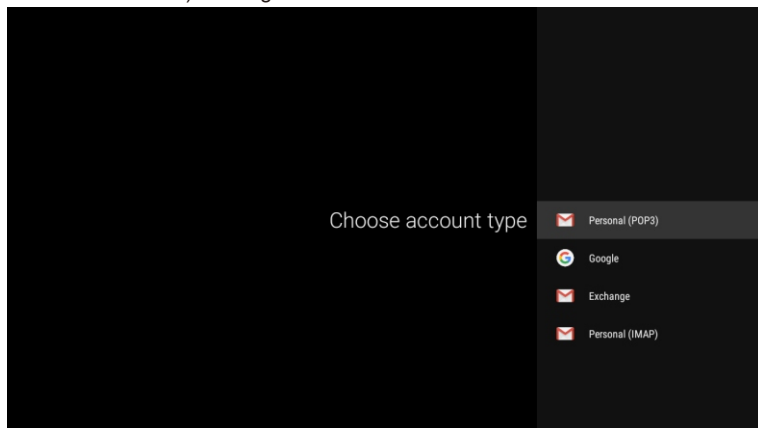

## Apps

Click the “Apps” option will jump to the following interface:

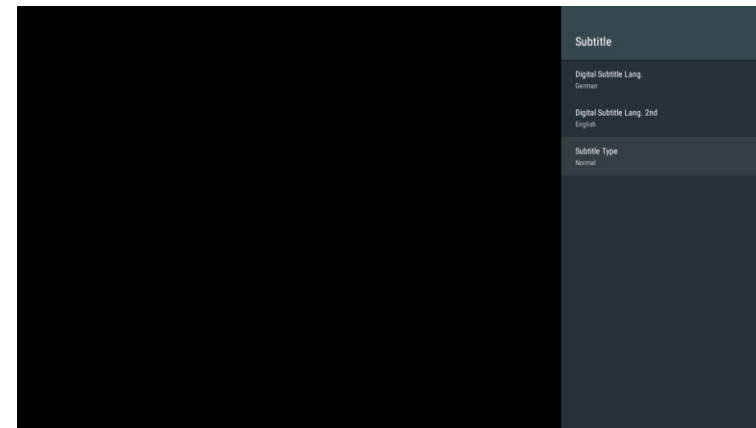

## Device Preferences

Click the “Device Preferences” option will jump to the following interface:

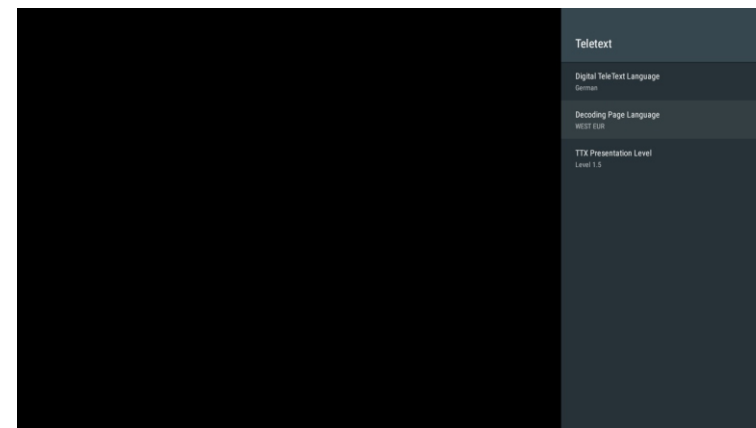

# Remotes & Accessories settings

Click the settings icon on the home page and the settings page will appear, as shown below:

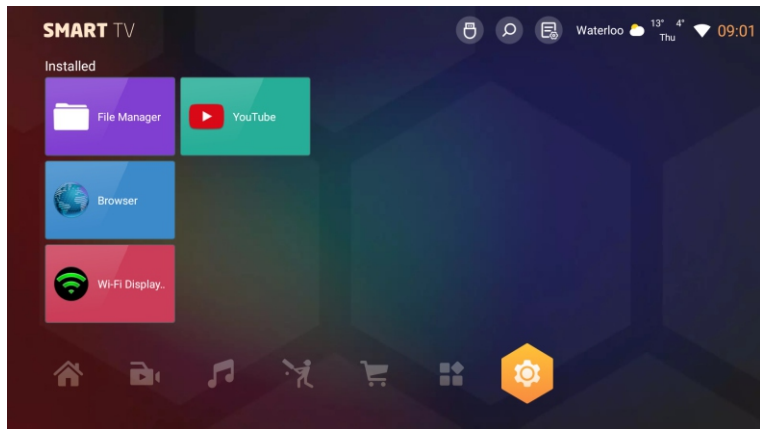

Choose "Remotes & Accessories" Item

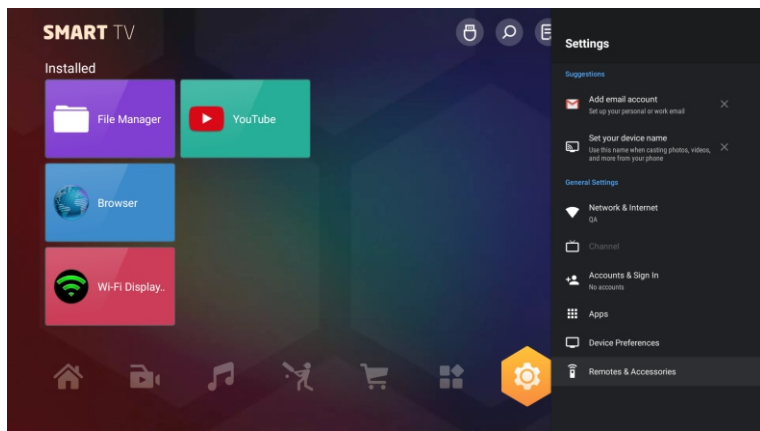

Click "Add accessory" Item

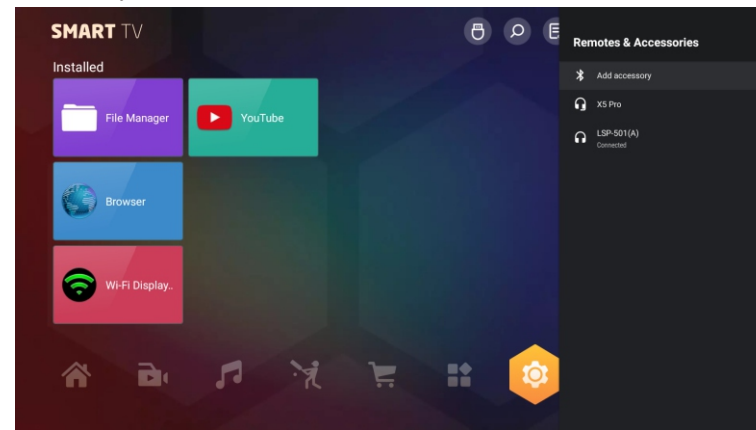

Start to Search Bluetooth device

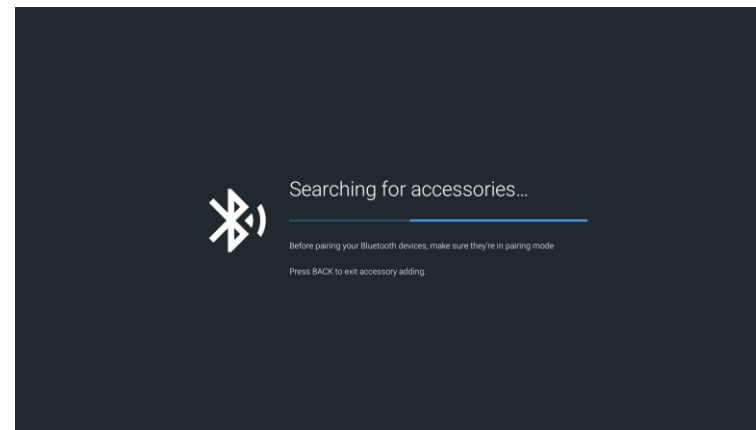

Choose the Needed Bluetooth device, when Matches Successfully Bluetooth will Start to Work

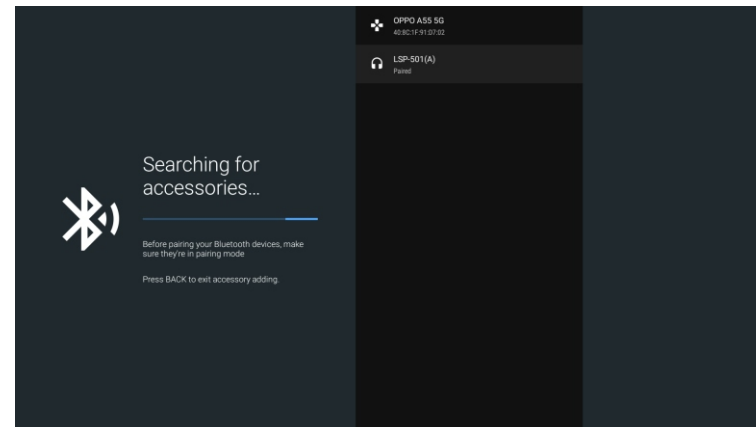



## FileManager

Click the usb icon in the upper right corner of the home page to enter the file manager page. As shown below:

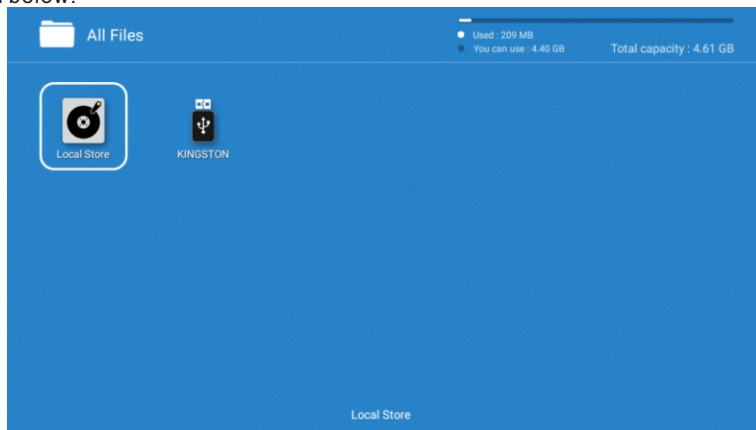

Click the corresponding drive letter to view the contents of the file in the USB, and select the file to view or play. As shown below:

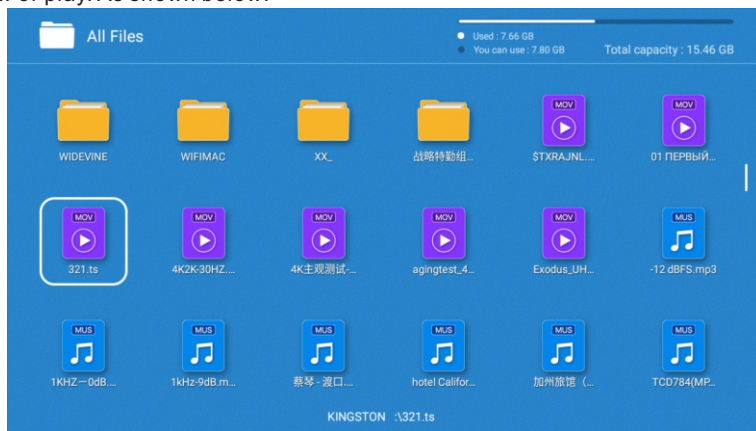

## Photo

Click the picture to enter the picture playback interface as shown below, press the left and right keys to move the cursor, and perform different operations according to the prompts. The functions of the icons on the right side of the interface from top to bottom are: picture information, zoom out, zoom in, playlist.

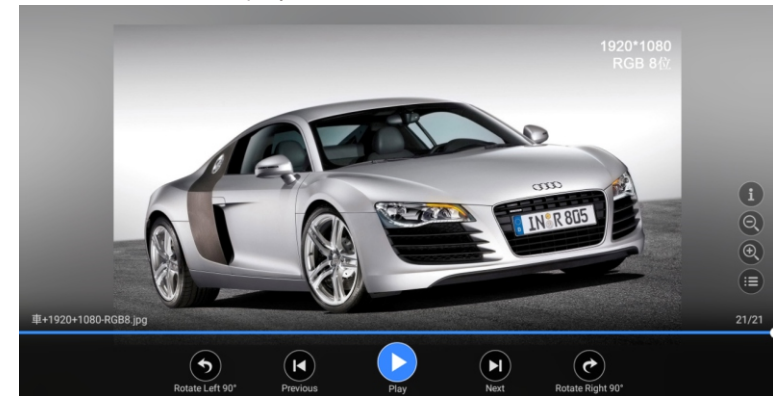







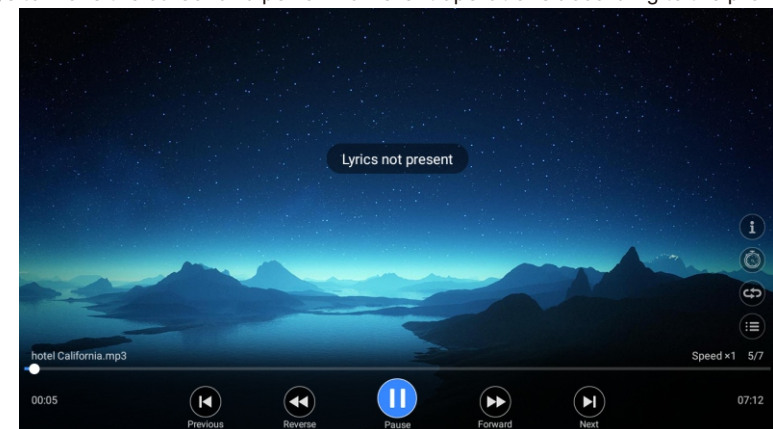

- Image Information
- enlarge
- Zoom out
- Zoom in
- Playlist
- Rotate 90 degrees counterclockwise
- Previous picture
- Play or pause
- Next picture
- Rotate 90 degrees clockwise

## Music

Click the music file to enter the music playback interface as shown below. Press the left and right keys to move the cursor and perform different operations according to the prompts.









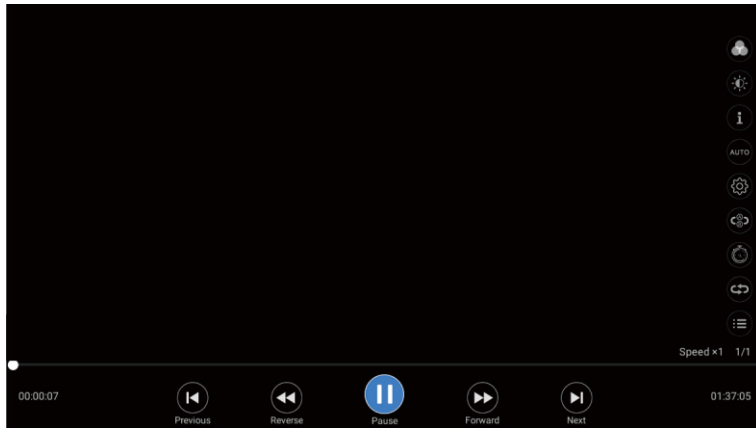





-  Previous song
-  Rewind
-  Play or pause
-  Fast forward
-  Next song
-  Music Information
-  Set the time begin to play
-  Set the play mode: Random play/All cycle/List play once/Single cycle
-  Playlist





## Movie

Click the video file to enter the video playback interface as shown below, press the left and right keys to move the cursor, and perform different operations according to the prompts.



-  Previous movie
-  Rewind
-  Play or pause
-  Fast forward
-  Next movie
-  Picture Setting
-  Video Information
-  Aspect Ratio: 4:3/16:9/Auto
-  Breakpoint play/Subtitle/Sound track setting
-  Segment repeat playback setting
-  Set the time begin to play
-  Set the play mode: Random play/All cycle/List play once/Single cycle
-  Playlist

## Troubleshooting

Problem	Possible cause	Possible solution
No picture and sound.	<ul style="list-style-type: none"> <li>• The power adaptor is not plugged in or not working.</li> <li>• The wrong input source is selected.</li> <li>• The input source has failed to connect with the TV or is not turned on.</li> </ul>	<ul style="list-style-type: none"> <li>• Plug the power into a suitable outlet.</li> <li>• Select the correct input source.</li> <li>• Make sure the input source is correctly connected and turned on.</li> </ul>
No sound.	<ul style="list-style-type: none"> <li>• The volume control is set to minimum.</li> <li>• The mute  button on the remote control has been pressed</li> <li>• An incorrect sound system mode is set.</li> </ul>	<ul style="list-style-type: none"> <li>• Press the  button to increase the volume.</li> <li>• Press  or the (or ) button to restore/increase the volume.</li> <li>• Set a correct sound system mode from the main menu to match your TV source.</li> </ul>
No picture, or monochrome picture only.	<ul style="list-style-type: none"> <li>• The colour system setting does not match the program.</li> <li>• The sound system setting does not match the program.</li> </ul>	<ul style="list-style-type: none"> <li>• Select the appropriate colour system setting.</li> <li>• Select the appropriate sound system setting. (If unsure, use Auto settings where available).</li> </ul>
Sound or picture interference.	<ul style="list-style-type: none"> <li>• Some equipment that causes interference is close to the TV.</li> <li>• More than one device is plugged into the same power outlet.</li> <li>• An incorrect sound system mode is set.</li> </ul>	<ul style="list-style-type: none"> <li>• Keep interference-causing equipment away from the TV.</li> <li>• Plug the power adaptor into another, separate power outlet.</li> <li>• Set a correct sound system mode from the main menu to match your TV source.</li> </ul>
PVR recording failed, or "DISK NOT READY" is displayed.	<ul style="list-style-type: none"> <li>• You may not have removed your USB device after the last recording, which is necessary to protect the device from damage.</li> </ul>	<ul style="list-style-type: none"> <li>• Remove the USB device after each recording if you experience recording problems. If "DISK NOT READY" is displayed, remove the device, reconnect and then proceed with your recording.</li> </ul>

<b>Problem</b>	<b>Possible cause</b>	<b>Possible solution</b>
DTV Picture Pixelation	• Poor Signal	<ul style="list-style-type: none"><li>• Adjust the position or orientation of the TV antenna.</li><li>• Check the antenna connection from the wall plate to the TV.</li><li>• Try re-tuning the channels as the channel frequencies may be different in some areas.</li></ul>

**Warranty**

Thank you for purchasing this Sylvox product. We are glad to offer 12 months free warranty for you. If you have any questions, please contact us via our after-sales email or website for assistance.

After-sales email: [service@sylvoxtv.com](mailto:service@sylvoxtv.com)

Website: [www.sylvoxtv.com](http://www.sylvoxtv.com)