

MODEL # ERK-OC-003

ROYAL

TRUE **ERGONOMICS**, TRUE **COMFORT**



PARTS / PIÈCES / PARTES / 部件清单

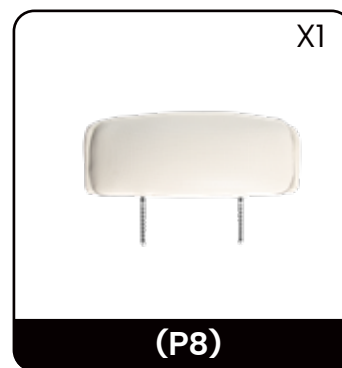
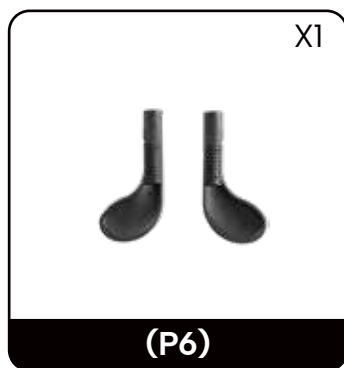
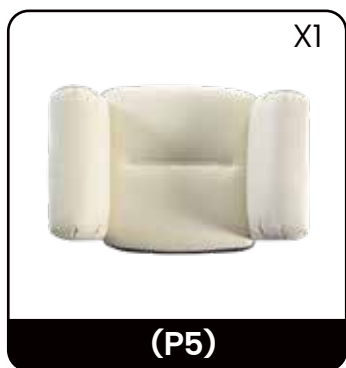
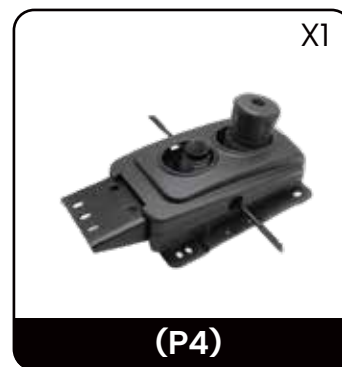
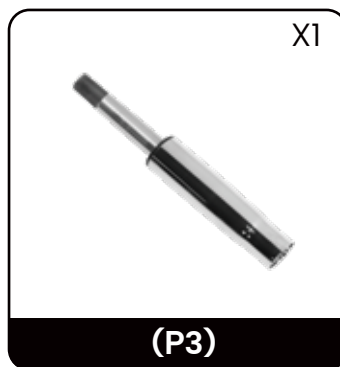
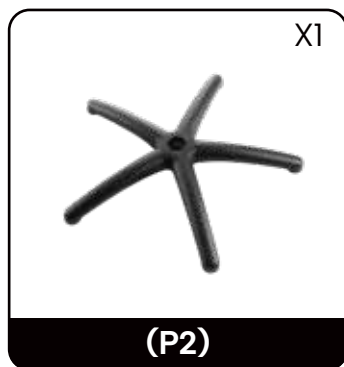
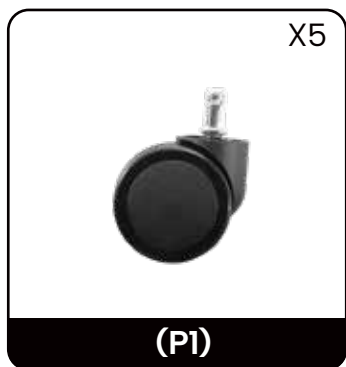

HARDWARE / MATÉRIEL / HARDWARE / 配件清单

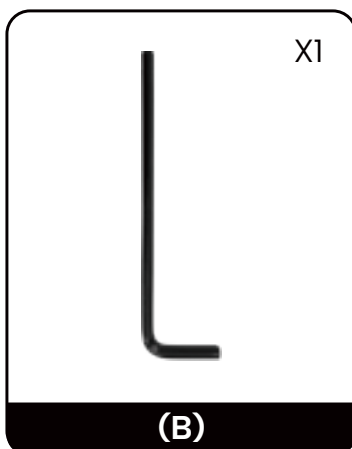

ASSEMBLY INSTRUCTIONS

INSTRUCTIONS DE MONTAGE

INSTRUCCIONES DE MONTAJE

安装说明

STEP 1

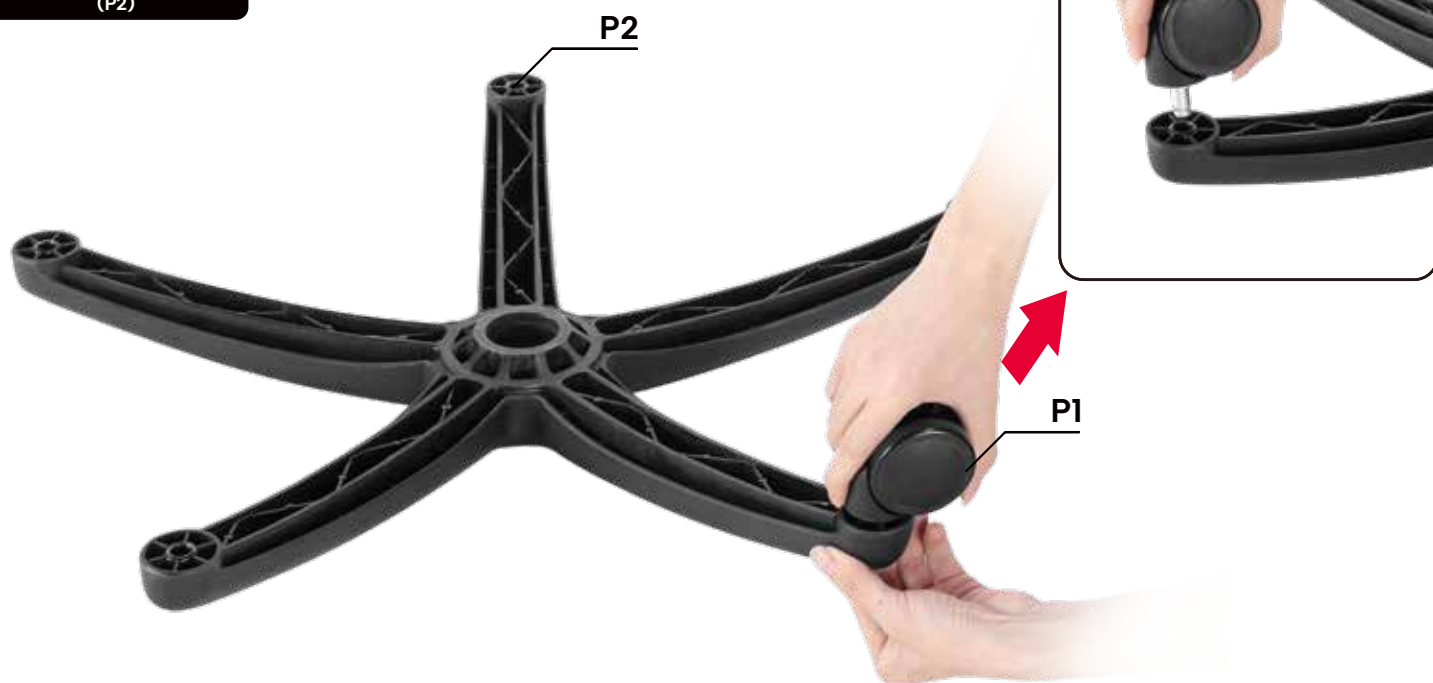

Push the casters (P1) into each end of the wheelbase (P2).

Poussez les roulettes (P1) dans chaque extrémité de l'empattement (P2).

Introduzca las ruedas (P1) en cada uno de los extremos de la distancia entre ejes (P2).

用力将脚轮 (P1) 推入五星脚 (P2)。

STEP 2



Insert the gas cylinder (P3) into the wheelbase (P2) and then remove the cap of the gas cylinder (P3).
Insérez la bouteille de gaz (P3) dans l'empatement (P2), puis retirez le bouchon de la bouteille de gaz (P3).
Inserte la bombona de gas (P3) en la distancia entre ejes (P2) y, a continuación, retire el tapón de la bombona de gas (P3).
先将气杆 (P3) 插入脚架 (P2)，再取下气杆 (P3) 的帽盖。

STEP 3

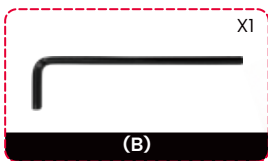
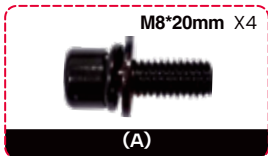

Attach the tilt mechanism (P6) to the bottom of the seatbase (P5) with the screws (A) and the allen wrench (B).
Fixez le mécanisme d'inclinaison (P6) au bas de l'assise du siège (P5) à l'aide des vis (A) et de la clé Allen (B).
Fije el mecanismo de inclinación (P6) a la parte inferior de la base del asiento (P5) con los tornillos (A) y la llave Allen (B).
将用螺钉 (A) 和内六角扳手 (B) 将底盘 (P6) 安装到坐垫 (P5) 上。

STEP 4



Note the orientation of the lever handles (P6).
Notez l'orientation des béquilles (P6).
Observe la orientación de las palancas (P6).
注意区分把手 (P6) 方向。



Insert the lever handles (P6) into (P4).
Insérer les béquilles (P6) dans (P4).
Inserte las asas de la palanca (P6) en (P4).
将摇杆把手 (P6) 安装到部件 (P4) 上。

STEP 5

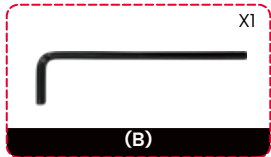
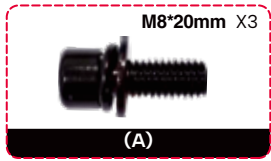

Attach the backrest (P7) to the seatbase (P4) with the screws (A) and the allen wrench (B).
Fixez le dossier (P7) à la base du siège (P4) avec les vis (A) et la clé Allen (B).
Fije el respaldo (P7) a la base del asiento (P4) con los tornillos (A) y la llave Allen (B).
用螺钉 (A) 和内六角扳手 (B) 将靠背 (P7) 安装到座部 (P4) 上。

STEP 6



Insert the gas cylinder into the socket of the tilt mechanism.
Insérez la bouteille de gaz dans la douille du mécanisme d'inclinaison.
Inserte el cilindro de gas en la toma del mecanismo de inclinación.
将脚架安装到底盘上。

STEP 7

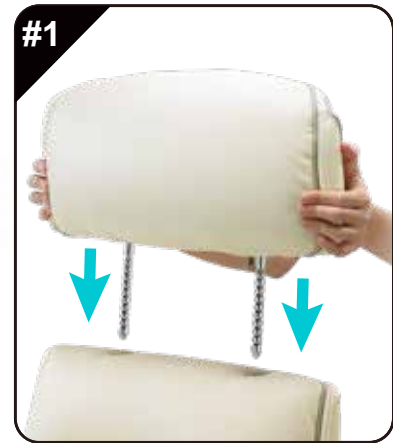
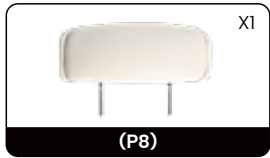

Insert headrest (P8) into backrest (P7).
Insérez l'appui-tête (P8) dans le dossier.
Introduzca el reposacabezas (P8) en el respaldo.
将头枕 (P8) 装入靠背 (P7)。