

AFERIV

Portable Power Station

AF-P310 | User Manual

3600W

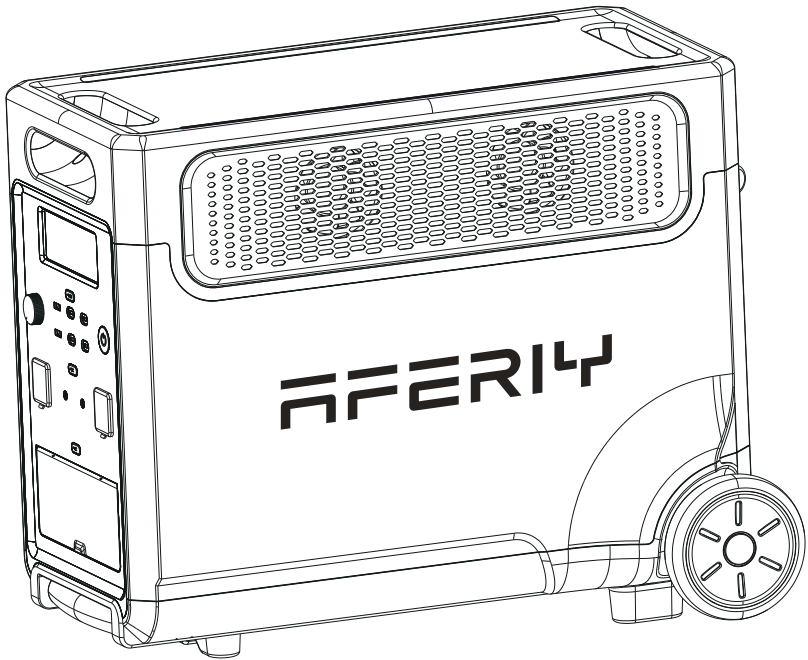



Hi dear, thank you very much for purchasing and experiencing our portable power station AF-P310. Before operating this product, please carefully read the user manual for proper operation.

According to the transportation requirements of the international customs for battery products, the battery level of this product is only less than 30% when it leaves the factory. Please fully charge the product after unpacking it to start the experience tour of our AF-P310.

Precautions For Use

1. Please avoid long-term storage and use of this product in environments with high temperature and humidity or direct sunlight to avoid shortened battery life and other failures. The product should not be close to the fire source, otherwise it may cause a major fire or accident.
2. This product must not be disassembled or modified. Improper operation may cause product malfunction or even fire.
3. Be careful not to drop or drop the product from a high place, so as not to damage the product
4. Please store or use this product out of the reach of children, otherwise the product may be dropped or collided and may cause bodily injury to children.
5. Please use our original accessories, and AFERIY will not guarantee the defective products caused by the use of non-original accessories.
6. Please directly plug in the wall socket to charge the product, do not use extension cords or cable taps, otherwise there is a risk of damage to the extension cords and cable taps or even a fire; If the extension socket is plugged in to charge this product, please do not connect other electrical appliances to this socket, otherwise the household meter may trip.
7. When the product is not in use or idle, please turn it off and unplug the power cable. If it needs to be idle for a long time, please consume the product from a fully charged state to an uncharged state, then recharge it to about 50% of the battery level and store it. In order to prolong the life of the product, please take three months as a cycle, operate and keep it in this way
8. If the product reaches scrap conditions, please discard or recycle the product in accordance with local laws.

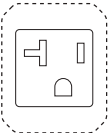
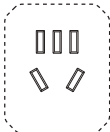
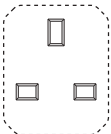
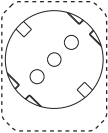
AC Output Parameter

Type of AC port	AC output
 US/JP	100V~120V 50/60Hz
 CH	220V 50Hz
 UK	220V~240V 50Hz/60Hz
 EU	220V~240V 50Hz/60Hz
 KR	220V 60Hz

Contents

• Packing List	01
• Product Introduction.....	01
• Button Function Introduction	02
• Introduction of Display Interface	05
• Troubleshooting table	06
• UPS Mode	07
• Connection of Solar Panels	08
• Car/Vehicle Charging	09
• Product Parameter.....	10
• Battery Specifications	10
• Disclaimer	11
• Warranty Card	12

Packing List



Portable Power Station



AC Charging Cable



User Manual



MC4-XT90

Product Introduction

This product is a portable power device with a built-in battery pack with charge/discharge function. It includes both AC output interface and DC output interface such as USB output, cigarette lighter output, DC output, etc. It also has functions such as display, interface control, protection, and alarm. Moreover, this product can be charged by mains AC, solar panels and vehicle charging.

The following are the main features of this product:

- Equipped with LiFePo4 battery, the battery capacity is as high as 3840Wh, and the safety level is extremely high.
- pure sine wave AC output can meet almost all daily electronic equipment and small household appliances.
- Two-way fast charging technology is adopted to fully charge the product within 3 hours.
- A great variety of output interfaces such as USB-A, Type-C PD3.0, DC5521, XT60, cigarette lighter output, etc., meet many different application scenarios.
- In UPS mode, the switchover time is less than 10ms which is truly seamless switching.
- Multiple protection mechanisms such as battery, circuit, structure, etc., guarantee the product safety.



Button Function Introduction

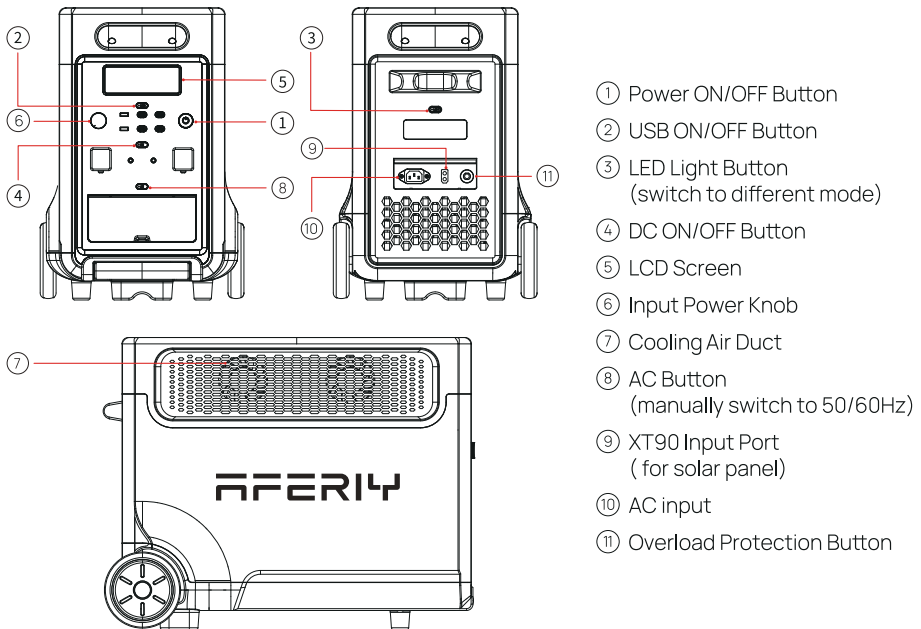

- ① Power ON/OFF Button
- ② USB ON/OFF Button
- ③ LED Light Button (switch to different mode)
- ④ DC ON/OFF Button
- ⑤ LCD Screen
- ⑥ Input Power Knob
- ⑦ Cooling Air Duct
- ⑧ AC Button (manually switch to 50/60Hz)
- ⑨ XT90 Input Port (for solar panel)
- ⑩ AC input
- ⑪ Overload Protection Button

① Power ON/OFF Button

Instructions: Press and hold the power button for 3S to turn on/off the whole system.

② USB ON/OFF Button

Instructions: Short press the USB button to turn on the USB output port, and short press it again to turn it off.

 USB-A X2 QC 3.0	 TYPE-C X3 PD-20W	 TYPE-C X1 PD-100W
---	--	---

③ Light Button

Instructions: Short press the LIGHT button, the LED light is on; short press it again, the LED light enters the SOS mode, short press in turn, enters the strobe mode, and finally the LED light is turned off (LED light in any mode, long press the LIGHT button for ≥ 1 second, directly turn it off).

4 DC ON/OFF Button

Instructions: Short press the DC button to turn on the DC output port, and short press it again to turn it off.

 DC output X 2 ----- 12V/3A	 Cigarette port X 1 ----- 12V/10A	 XT60 X 1 ----- 12V/25A
---	---	---

5 LCD Screen

Display the product's battery level and usage status tips.

6 Input Power Knob

When the product is connected to the AC mains for charging, the power is adjusted according to the actual input voltage. The clockwise rotation increases the input power, and the counterclockwise rotation decreases the input power. It is worth noting that charging this product at low power is beneficial for extending battery life.

7 Cooling Suction/Exhaust Port

When the product reaches the temperature threshold set by the system, the cooling fan will automatically run, accompanied by a certain fan noise (fan noise below 60dB is normal). Do not block the cooling suction/exhaust port during use of this product, and do not place any object within the range of 30CM.

8 AC Button

Tap the AC button to enable the AC output function. Since there may be differences in the AC output frequency and voltage in different regions, if you need to switch the frequency and voltage, the operations are as follows:

- 1) Press and hold the AC button for 3 seconds to enter the frequency switching mode, the 50Hz or 60Hz icon will flash on the display, short press the AC button again to select 50Hz or 60Hz; when the icon stops flashing and displays 50Hz or 60Hz, it indicates the switch is successful.
- 2) Quickly press the AC button for 10 times to select voltage.

9 XT90 Port (Solar Panel Input)

This interface supports solar panel input or car charger input. For details, please refer to "Solar Panel Connection" on page 8 of this manual and "Car/Vehicle Charging" on page 9.

⑩ AC Input

To charge the product by a household socket can achieve 2200W fast charging. It only takes two hours to fully charge from 0 to 100%. When charging in this way, please pay attention to the following points:

- ※ Please directly plug in the wall socket to charge the product, do not use extension cords or cable taps, otherwise there is a risk of damage to the extension cords and cable taps or even a fire.
- ※ If the extension socket is plugged in to charge this product, please do not connect other electrical appliances to this socket, otherwise the household meter may trip.

⑪ Overload Protection Button

When the power supply voltage is unstable due to lightning or other reasons, and there is a large voltage input at the AC Input, in order to protect the product, the overload protection function (safety circuit breaker) will activate and cut off the AC input port.

Please follow the sequence below to restore the AC input function:

- 1) Turn off the power button and unplug all ports.
- 2) After confirming that there is no abnormality in each part, turn on the power button.
- 3) Press the overload protection button, connect the AC Cable to restore the AC input.

Introduction of Display Interface

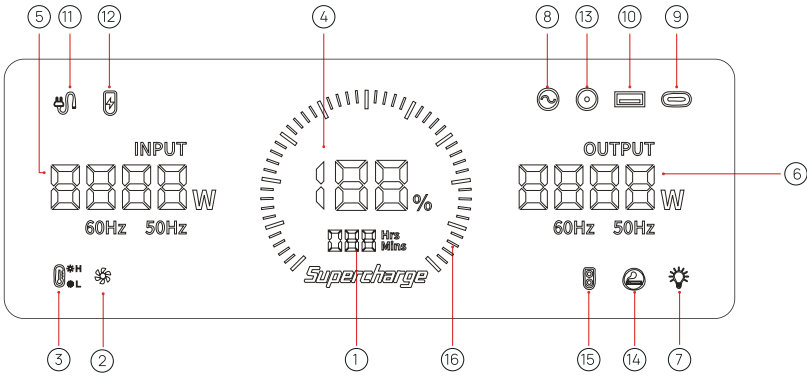

- | | | | |
|--------------------------------------|----------------------------|--------------------------------|---------------------------------|
| ① Remain Using/
Recharging Time | ⑤ Input Power
in Total | ⑨ PD3.0 Output | ⑬ DC (12V) Output |
| ② Fan Status | ⑥ Output Power
in Total | ⑩ USB Output | ⑭ Cigar Lighter (12V)
Output |
| ③ High/Low Temperature
Protection | ⑦ LED Light | ⑪ Connected to the
AC Mains | ⑮ XT60 (12V) Output |
| ④ Battery Level Percentage | ⑧ AC Output | ⑫ XT90 | ⑯ Battery Progress Bar |



Screen Display Description

Power display: When the product is in the charging state, the battery progress bar rotates continuously in the form of a clockwise marquee, and the battery level percentage gradually increases; when the product battery level is 0, the battery level percentage icon flashes.

Input and output status: When the product is working, the total input power, total output power and the cursor corresponding to the working area will be displayed on the screen.

Alarm prompt: See the following troubleshooting table for details.

Troubleshooting table

Phenomenon	Cause	Processing method
 <p>The above output icon flashes and beeps.</p>	<p>The output exceeds the standard and it's short-circuited.</p>	<p>Remove the load, and then short press the switch in the area corresponding to the icon to remove the alarm</p>
 <p>The temperature warning icon flashes and beeps.</p>	<p>The temperature of the product is too high or too low.</p>	<p>Take the product out of the charging state, remove all loads, turn the power off, wait for the device to reach a suitable working temperature, then the alarm is removed.</p>
 <p>The icon of connecting to the AC mains flashes and the product cannot be charged.</p>	<p>The charging cable is poorly connected.</p>	<p>The overload protection function is enabled</p>

If you have any questions, please feel free to contact us.

Email address: support@aferiy.com.

Sincerely,

UPS Mode

- **UPS Feature**

This product has the function of backup uninterruptible power supply. The usage and operation precautions are as follows:

As shown in Pic 1 below, when the product is connected between the wall socket and the electrical appliance, and the power supply and AC switch of the product are in the ON state, the product enters the UPS working mode. The AC mains in the socket supplies power to the electrical appliance through the bypass circuit, and also charges the product. In this working state, the rated power of the electrical appliance must be lower than 2200W, otherwise overload protection may be triggered.

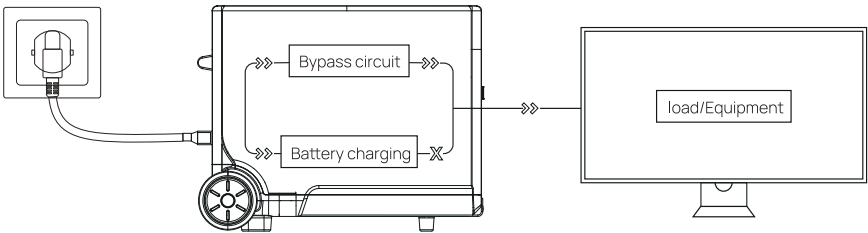

(Pic 1)

As shown in Pic 2 below, when the AC mains at the socket end is disconnected, the bypass output inside the product stops working, the product switches to a bidirectional inverter circuit within 10ms, and the circuit outputs supply power to the electrical appliance to ensure that the electrical appliance is uninterrupted and works normally during the process.

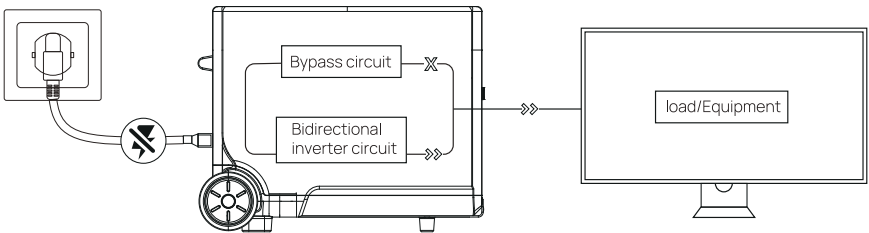

(Pic 2)

Connection of Solar Panels

Under the condition of light, this product can be connected to the solar panel and getting charged. The charging power is determined according to the conditions of light and weather.

In this charging mode, we support solar panel input within 2000W, and the input voltage cannot exceed 160V, otherwise the product abnormality caused by it will not be covered by the warranty.

We recommend the following two charging schemes:

Solar panel charging

Scheme one

Portable Power Station Charging Area

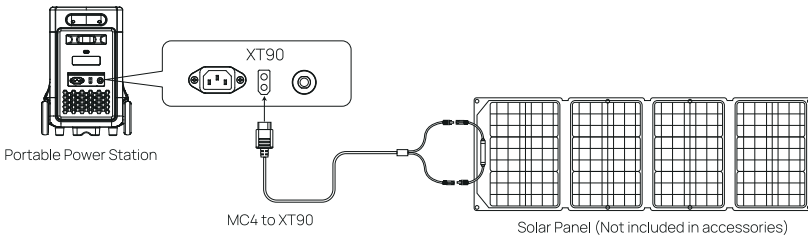

Scheme two

Portable Power Station Charging Area

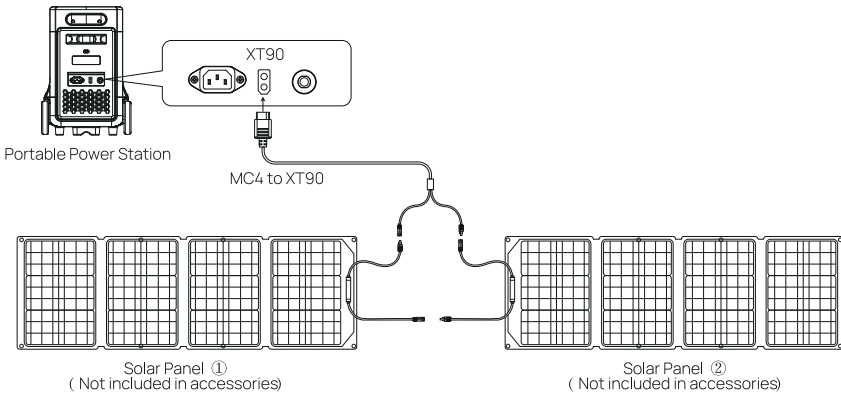

Car/Vehicle Charging

When the car is in the process of starting, connect the car charging port on the car and the product through the car charging cable to charge the product. The connection method is shown in the picture below:

This product supports 12V/24V car charger charging, please pay attention to the following two points when using this method to charge:

- ※ Please do it when the car started, otherwise the car battery may be exhausted.
- ※ Vehicle charging power is usually in the range of 90W-120W, and the charging time is long.

If fast charging is required, the AC mains charging is recommend-ed.

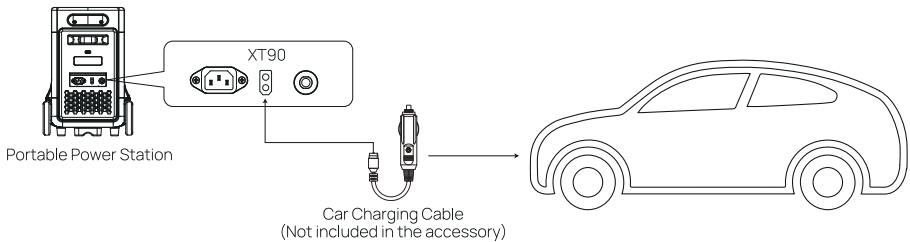

Product Parameter

Product Name	Portable Power Station
Dimension	L*W*H=584X321X464mm
Weight	40.0kg
Capacity	3840Wh
AC Charging	100V-120V 1500W max;220V-240V 2200W max
XT90 Input	12-160V 2000W max
AC Output	100V-120V, rated 3300W, 220V-240V, rated 3600W; pure sine wave
USB-A Output	(QC3.0 18W) X2
Type-C ① Output	(PD20W) X3
Type-C ② Output	(PD100W) X1 Included PD3.0 protocol
DC 5521 Output	12V/3AX2
XT-60 Output	12V/25A
Car Charging Output	12V/10A
Shutdown Current	< 500uA
Working Temperature	-10 ~ 40°C
Environment Humidity	≤90%RH
Cycle Times	> 3500 times

Battery Specifications

Cell type	40135 LiFePo4
Rated voltage of single battery	3.2V
Rated capacity of single battery	20Ah
Rated voltage of battery pack	48V
Output voltage range of the battery pack	42V-54V
Rated capacity of battery pack	3840Wh

Disclaimer

Before use, please read the user manual of this product to ensure full understanding and correct use. After reading, keep the user manual properly for future reference. If you do not operate this product correctly, you could cause serious injury to yourself or others, or result in damage to the product and property. Once you use this product, you are deemed to have understood, recognized and accepted all terms and content of this document. Users undertake to be responsible for their own actions and all consequences arising therefrom. AFERIY is not responsible for all losses caused by the user's failure to use the product in accordance with the User Manual.

In compliance with the law, the company has the final right to interpret this document and all related documents of the product. If it is updated, revised or terminated without prior notice, please visit the AFERIY official website for the latest product information.

Warranty Card

Warranty Card	
Model	
Name	
Address	
Tel	
Mail	
Name of the store	
Buying date	
Please fill in all the above items.	

This product provides a 24-month warranty service from the date of purchase

- If there is a quality problem within the range of normal use, we provide warranty service.
- After purchasing our company's products, please keep this product together with invoices and other items. When maintenance services are needed, please provide information according to our company's request.
- In the case where the warranty is damaged or altered, and no stamp of the sales store on the warranty, the warranty service may not be provided.
- Damage caused by use beyond the normal range of use is not covered by the warranty service.
- The content of the warranty scope shall be subject to the content recognized by the company.
- Even within the scope of the warranty, sometimes it will be exchanged for products with the same function. The shipping and repair fees for products outside the warranty range shall be paid by the customer.
- Sometimes the specifications and functions of the product will be updated without prior notice.