

TurboAnt

Folding Electric Scooter

X7 Pro

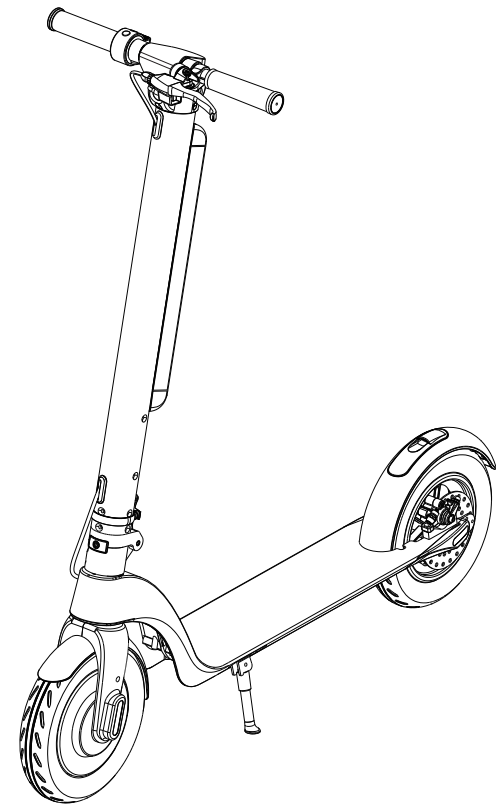

Email: support@turboant.com
Website: www.turboant.com
Made in China



User Manual

Thank you for purchasing this product. To avoid injury to the user and others, be sure to observe the following safety instructions and guidelines. Keep this information for future reference.

Introduction



Featuring 10" tubed pneumatic tires, this scooter gives you a smooth riding experience. Its powerful 350 watt motor and 36 V battery enable a speed of up to 20 mph with a range of up to 30 miles. The reinforced frame reliably supports a body weight of 44-275 lb.





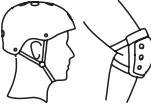

Important Safety Instructions and Guidelines

Safety Checks

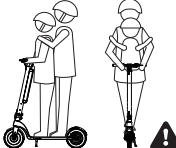
- Follow the left and right markings on the handlebars to ensure proper installation.
- Make sure that no parts are damaged or have been modified.
- Make sure that the stem has been secured properly.
- Make sure that the Hall cable under the brake lever is connected correctly and the brakes operate properly.
- Make sure that the tires are fully inflated.
- Make sure the battery is fully charged (the indicator light turns green).
- Test whether the scooter can be turned on/off.
- Make sure that the front and rear lights function properly in the dark.
- Children under 14 years old should be supervised by an adult.

Safety Guidelines

	<p>WARNING! RISK OF BATTERY EXPLOSION! Do not use the battery if it is damaged or has been modified. Do not expose to heat exceeding 95 °F (35 °C). Only use the original charging adapter.</p>
	<p>Wear protective gear such as a helmet.</p>
	<p>Do not ride the scooter in wet conditions.</p>

	<p>The scooter is only suitable for driving by a single person.</p>
	<p>Do not ride under the influence of drugs or alcohol.</p>
	<p>The load is between 44-275 lb (20-125 kg).</p>
	<p>Do not call or listen to music when riding the e-scooter.</p>
	<p>Check your local traffic regulations whether driving an e-scooter in traffic is legal or not in your area.</p>
	<p>Turn on the lights in the dark.</p>

Package Contents

- 1 × Folding Electric Scooter
- 1 × Charging Adapter
- 1 × M6 Hexagon Wrench
- 1 × Valve Adapter
- 1 × User Manual
- 1 × Warranty Card

Technical Specifications

Product Information	Unfolded Size	42.6 × 16.5 × 46.7 in (1083 × 420 × 1186 mm)
	Folded Size	42.6 × 16.5 × 18.1 in (1083 × 420 × 460 mm)
	Ground Clearance	4.5 in (115 mm)
	Product Weight	33 lb (15 kg)
	Adapter Input Voltage	100-240 V AC, 50/60 Hz
Drive System	Motor	36 V, 350 W
	Tire (Front & Rear)	10-inch, tubed pneumatic tires
	Max Speed	20 mph (32 km/h)
	Range	20-30 miles (32-48 km)
	Max Climbing Capability	15°
	Load	44-275 lb (20-125 kg)
Functions	Foldable Stem	Yes
	Battery Pack	Detachable
	Brake System	Electronic throttle control, disc brake and foot brake
	Speed	3 settings (linear adjustment)
	Illumination	LED headlight + taillight (1 W)
	Warning Function	Bell
	IP Rating	IPX4
Operating Conditions	Operating Temperature	32 to 95 °F (0 to 35 °C)
	Storage Temperature	14 to 104 °F (-10 to 40 °C)

Notes

1. Max speed values stated in the user manual depend on the road conditions and the load. Values stated on the rating label are related to average conditions.
2. Mileage is tested under the following conditions: the scooter is driven with the second speed level, 41.8 V full power battery, a load of 165 lbs (75 kg), temperature of 77 °F (25 °C), humidity of 70%, gentle breeze, tire pressure of 34.8 psi (240 kPa), and flat, dry road conditions. Actual results may vary. If the load exceeds 220 lb (100 kg), the mileage and speed may be decreased, which can affect the riding experience.
3. Please drive safely within the maximum speed limit set by local traffic officials. Everyone should strictly abide by all traffic rules and regulations.

Battery Specifications

Type	Li-ion
Charging Time	Approx. 6 hours
Voltage	36 V
Capacity	10 Ah, 360 Wh
Operating Temperature	32 to 95 °F (0 to 35 °C)
Charging Temperature	50 to 95 °F (10 to 35 °C)
Max Charging Voltage/Current	42 V, 2 A
Storage Temperature	14 to 104 °F (-10 to 40 °C)
Storage Time	3 months (after a full charge)

Charger Specifications

Model	FY-4202000
Manufacturer	Shenzhen Fuyuan Power Co., Ltd.
Input	100-240 V AC, 50/60 Hz
Output	42 V DC, 2 A

Product Overview

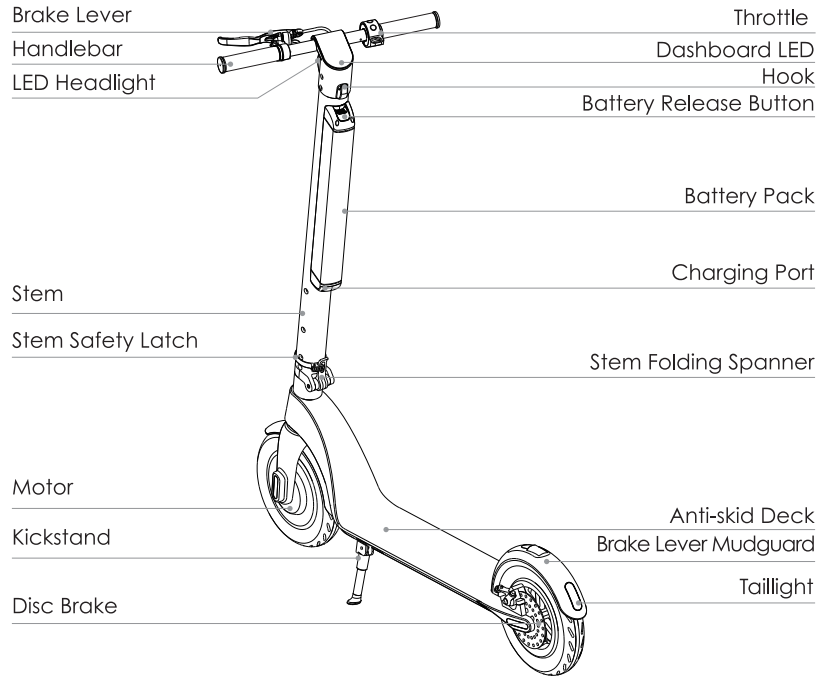

Controls Overview

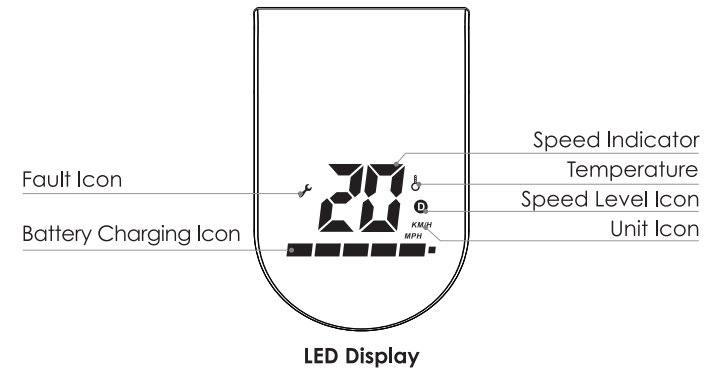
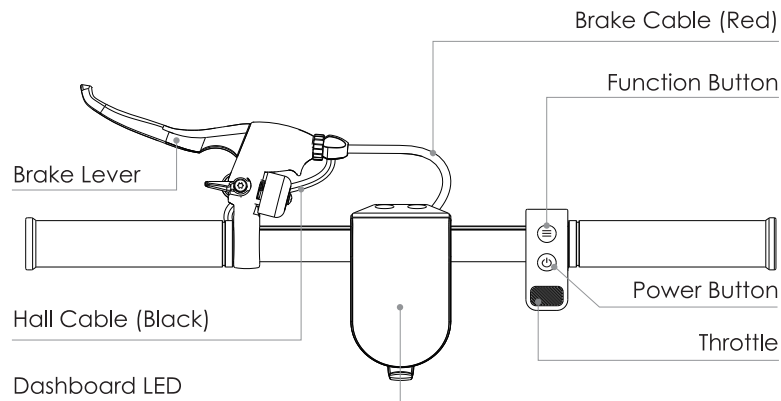

Note: If there is no operation within 10 minutes, the LED display will automatically turn off with a "beep" sound.

Controls Description

Parts/Functions	How to Operate	
Power Button	Long press to turn the scooter on/off.	
Throttle	Press the throttle down to accelerate.	
Brake Lever	Hold the brake lever to assist the mudguard brake. Note: When the brake lever is pressed down, the scooter will completely stop. After that, the scooter will have to be manually started (see the General Troubleshooting and Solution Guide section).	
Function Button	Short press the function button to adjust the speed level.	Low Level: no icon
		Medium Level: "D" icon in white
		Sports Level: "D" icon in red
Headlight	Press the function button twice rapidly to turn the headlight and taillight on/off.	
Cruise Mode	Accelerate the scooter to the desired cruising speed (must be greater than 3.7 mph (6 km/h) to activate cruise mode) and keep the speed constant. Then, hold the throttle in the same position for 6 seconds to enable cruise control. Exit cruise mode by triggering the throttle again or by braking.	

Operating Instructions

Assembly

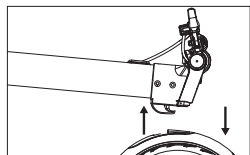
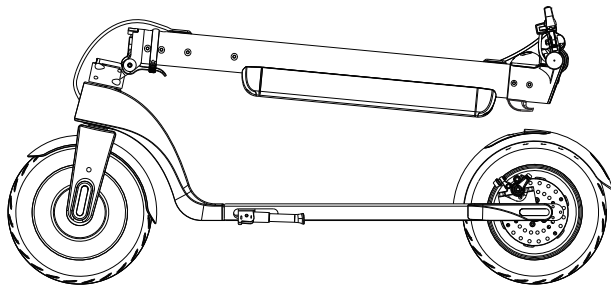

1. Press down the mudguard and raise the stem completely.

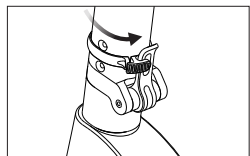

2. Lift the stem folding spanner up completely and secure it by rotating the stem safety latch counterclockwise.

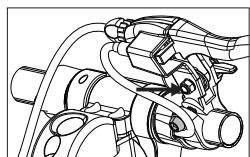

3. Fix the brake lever securely with the M6 hexagon wrench.

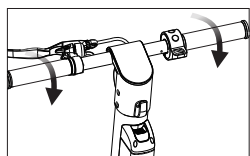

4. Then, tighten the handles by rotating backwards.

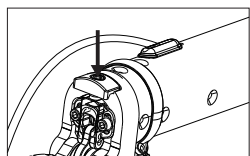

5. Tighten the screws on the stem folding spanner if the stem is loose.

Stem Folding

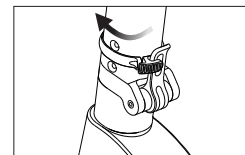
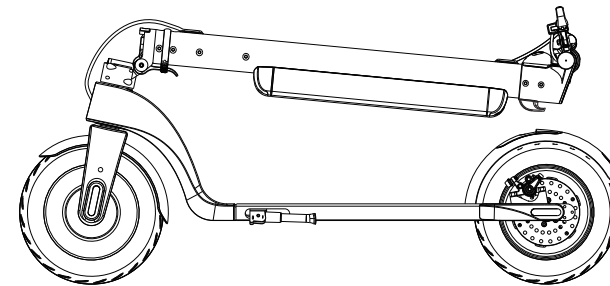

1. Release the stem safety latch by rotating it clockwise.

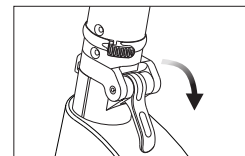

2. Pull down the stem folding spanner.

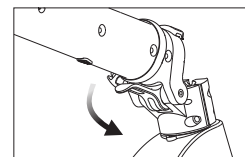

3. Lower down the stem.

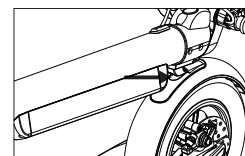

4. Secure the stem onto the mudguard.

Battery Removal

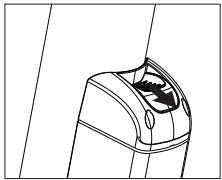
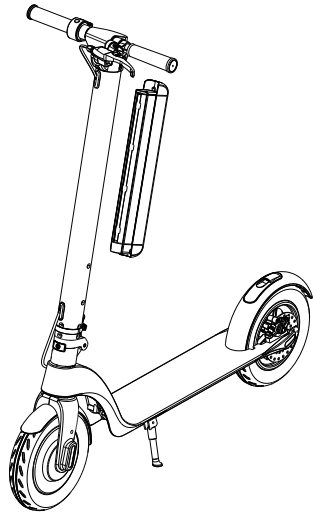

1. Hold down and pull out the battery release button to release the battery pack.

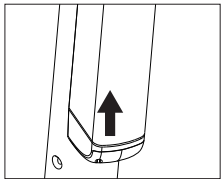

2. Push the battery pack upwards while pulling and holding down on the battery release button.

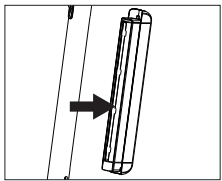

3. Pull out the battery pack horizontally.

Battery Installation

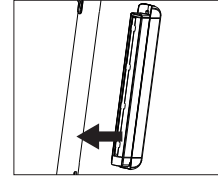

1. Insert the battery pack horizontally by aligning the battery pack grooves with the linings of the battery pack compartment.

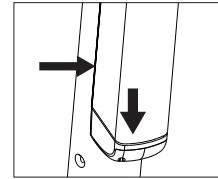

2. Make sure the battery pack is aligned to the stem. Press down on the battery pack until an audible click can be heard, indicating that the battery pack has been locked in place properly.

Battery Maintenance

1. Only use the original battery pack. Misuse of other models or brands can cause safety issues.
2. Only use the original power adapter to avoid potential damage, electric shock, or fire.
3. Mishandling of used batteries can cause tremendous harm to the environment. To protect the natural environment, please follow local regulations to properly dispose of used batteries.
4. Do not place the battery in an environment where the ambient temperature is higher than 122 °F (50 °C) or lower than -4 °F (-20 °C) (e.g., do not leave the scooter or the battery pack in a car under direct sunlight for an extended time).
5. Do not leave the battery pack near a heat source, such as a stove, and do not throw the battery pack into fire. Doing so may result in overheating, explosion, or fire.
6. After every use, fully charge the battery to prolong its lifespan.
7. If the scooter is expected to be left unused for more than 30 days, please fully charge the battery and place it in a dry and cool place. Keep in mind to recharge the battery every 30 days to protect it from potential damage, which is beyond the coverage of our limited warranty. Always charge before exhausting the battery to prolong the battery's lifespan.
8. The battery pack performs better within the normal temperature range of 32 to 95 °F (0 to 35 °C), and performs worse when below 32 °F (0 °C). For instance, when the temperature is below -4 °F (-20 °C), the actual mileage will only be half or less than listed. When the temperature rises, the mileage will restore. Note: A fully charged TurboAnt Electric Scooter will last for 120-180 days.
9. The built-in intelligent chip will keep a log of its charging and discharging records. The damage caused by prolonged periods without charging is irreversible and is beyond the coverage of our limited warranty. Once the damage is done, the battery cannot be recharged.

Riding the Scooter

1. Wear protective gear such as a helmet.
2. Hold the power button for 2 seconds to turn on the scooter.
3. Place the foot of your weaker leg on the middle of the deck.
4. Build up sufficient momentum with your stronger leg.
5. Place the toes of the other foot onto the rear of the deck and the heel onto the mudguard.
6. Gently press down the throttle to accelerate.
7. Step down onto the mudguard to break and assist the breaking by pressing the brake lever.

Battery Charging

Charging the Installed Battery

1. Remove the charging port cover at the bottom of the stem. Make sure the charging port is dry and free of dust.
2. Connect the charging adapter.
3. The battery is fully charged when the indicator light of the charging adapter turns from red to green.
4. Close the charging port cover after charging the battery.

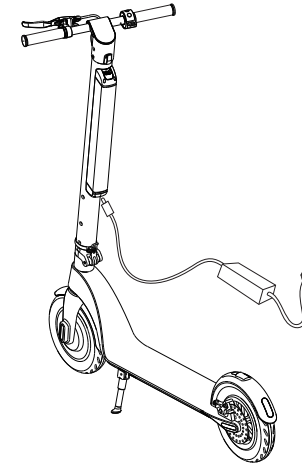

Charging the Removed Battery

1. Remove the battery (Battery Removal).
2. Open the charging port cover at the bottom of the battery. Make sure the charging port is dry and free of dust.
3. Connect the charging adapter.
4. The battery is fully charged when the indicator light of the charging adapter turns from red to green.
5. Close the charging port cover after charging the battery.

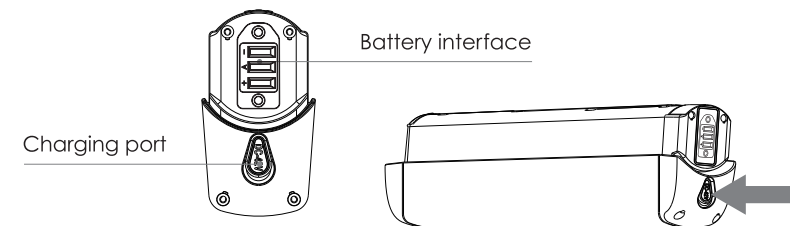

⚠ Only use the original charging adapter to charge the scooter.

Maintenance

1. Make sure the scooter is turned off and the power adapter is disconnected.
2. Wipe clean the scooter with a damp cloth. Never use lubricating oil on the body and do not immerse it in water.

Storage

1. Fully charge the scooter before storage and monthly to prevent a premature decay of the capacity.
2. Do not charge if the temperature is below 50 °F (10 °C).
3. Keep the scooter in a dry and ventilated area away from direct sunlight exposure, and protect it with a cover to protect it from dust.

General Troubleshooting and Solution Guide

Problem	Cause	Solution
The scooter will not turn on.	The battery has run out.	Recharge the battery.
	The battery is not properly installed.	Check whether the battery cover is fully tightened. 1. If it is fully tightened, the battery installation is proper. 2. If it cannot be fully tightened, the battery installation is improper. Please take out the battery and check for debris inside the scooter's stem or other blockage on the battery terminals. If there is debris, please remove and re-install the battery.
	The throttle has not been reset.	Rotate the throttle upwards as far as it will go. Then, press the power button. If the scooter still does not turn on, the throttle has broken down. Replace the throttle.
The battery will not charge.	The charging adapter is not connected to an AC power source, or the charging adapter is damaged.	1. Connect the adapter to an AC power source. If the indicator light turns on, the adapter is in good working condition. Then, connect the adapter to the charging port on the stem or the battery (the battery can be detached for flexible charging). 2. If the indicator light does not turn on, the adapter has broken down. Replace the adapter.

	The charging adapter is not properly connected to the charging port on the stem or the battery.	Check whether the connector of the charging cable is fully inserted into the charging port on the stem or battery. 1. If it is fully connected, then connection is normal. 2. If it is not fully connected, please unplug the cable and re-connect the cable to the charging port.
	The battery power is full or the battery has failed.	After confirming that the charging adapter is functioning, connect the charging adapter to the AC power source and the charging port on the stem. 1. If the indicator light turns red, then charging is normal and the battery is in good working condition. 2. If the indicator light turns green, then the battery is full or has reached failure. In case of failure, replace the battery.
Cruise control cannot be activated.	The current speed is below the minimum speed required for cruise control.	Cruise control can only be activated when travelling at speeds greater than 3.7 mph (6 km/h). Increase speed to enable cruise control.
	The current speed is not constant.	Keep the current speed constant. Then, hold the throttle in the same position for 6 seconds to enable cruise control.
	The cruise control function is not enabled.	Enter the function settings and enable the cruise control function.
The stem is loose.	The screws on the stem folding spanner are loose.	Tighten the screws on the stem folding spanner.
The scooter cannot accelerate.	The scooter is set at "non-zero" start and has not been manually started.	Ride the scooter for a short distance while powering manually. When the scooter's speed reaches 1.9 mph (3 km/h), the scooter can be accelerated.
	The throttle is not released.	The throttle is equipped with an electric lock, so it is required to completely press down the throttle in order to accelerate the scooter.
Normal tire pressure is between 31.9-34.8 psi (220-240 kPa). It is necessary to periodically check the scooter's conditions to make sure it is in safe operating mode, including the throttle, remaining power, tire pressure, and more.		
The tire has an air leak.	The tubed pneumatic tires may have an air leak if they are stored for a long period. This is normal, as most air tires require pumping periodically.	Pump up the tires by taking the scooter to an automobile or motorbike repair center, or any location with a proper air compressor. Standard bicycle pumps can also be used to pump up the scooter tires.

Frequently Asked Questions (FAQs)

1. What is the optimum tire pressure when riding this scooter?

The recommended tire pressure is between 31.9-34.8 psi (220-240 kPa). Please pump up the tires to this pressure.

2. The headlight cannot be turned on or is abnormally lit. How can I solve this problem?

If the headlight won't turn on, please verify that the scooter is turned on. When the scooter is turned on, press the function button twice rapidly to see whether the headlight functions. Also, check to ensure that the lamp holder is not clogged with dust. If the lamp holder is not clogged with dust, and the headlight still will not turn on, it may need to be replaced. Please contact our customer support center for help.

3. What should I do if the scooter's stem is swaying while riding the scooter?

Immediately stop riding the scooter. Verify that the screws that connect to the folding spanner and other screws on the stem are well tightened. If not, tighten the screws using the hexagonal wrench. Periodically tightening the screws on the scooter may be necessary.

4. What should I do if the brakes are not functioning properly?

(1). Turn on the scooter. Don't stand on the deck. Tilt the scooter to lift the front wheel. Then, press down the throttle to accelerate, and the front wheel should start to rotate. Next, hold the brake lever. If the front wheel stops rotating, the EBS (Electronic Braking System) is functioning properly. If the front wheel does not stop rotating, the Electronic Braking System may be faulty. Please contact our customer support center for help.
(2). Turn off the scooter, and tilt the scooter so that the rear wheel can rotate. Then, hold the brake lever. If the rear wheel stops rotating and there is no grinding noise, the disc brake is functioning properly. If there is a grinding noise on the brake, the disc brake may be faulty. Please contact our customer support center for help.

5. The battery is not charging. What's the problem?

Verify that the charging adapter is in good condition. Plug the charging adapter into an AC power source without connecting to the scooter. If the indicator light turns on green, the charging adapter works normally. If the indicator light does not turn on or is lit red, the charging adapter is faulty. If the battery still cannot be charged with a normal charging adapter, the battery may have an over-discharge. Please contact our customer support center for help.

6. Why can't the throttle function properly, even when pressed down fully?

Make sure the scooter's initial speed is above 1.9 mph (3 km/h). If the speed is not above 1.9 mph (3 km/h), the scooter will not accelerate. If the scooter still cannot accelerate, please contact our customer support center for help.

7. Can I replace the tires on my own if I have a flat tire?

If you have a flat tire, please contact our customer support center for help and repair. It is not easy to replace on your own, and faulty installation may damage other parts of the scooter, which can nullify our limited warranty. Seek help via our customer support center or take the scooter to an automobile or motorbike repair center and ask the professionals for assistance.

8. Why does the battery life decrease over time?

The lithium-ion battery will naturally degrade its maximum capacity after 500 charge/discharge cycles. The battery performs better when within the normal temperature range of 32 to 95 °F (0 to 35 °C) and performs worse when below 32 °F (0 °C). For instance, when the temperature is below -4 °F (-20 °C), the actual mileage will only be half or less than listed.

9. Why has my motor suddenly stopped working?

The reason may be that the controller has malfunctioned, which may require a new replacement. Please contact our customer support center for help and repair.

10. When I press down the throttle, why doesn't the motor function properly?

It could be that there is a Hall wire malfunction with the Electronic Braking System. Please check to see if the wire terminals of the brake lever and the LED panel are loose, and whether the brake lever has been damaged.

11. Why can't my mileage reach 30 miles?

The max listed mileage is 30 miles, which is measured under the following conditions: the scooter is driven with the second speed level, 41.8 V full power battery, a load of 165 lb (75 kg), temperature of 77 °F (25 °C), humidity of 70%, gentle wind, tire pressure of 34.8 psi (240 kPa), and flat, dry road conditions. Please note that the tire is a type of tubed pneumatic tire, so fully inflating the tires can help extend your mileage.

Environmental Protection

Waste electrical products should not be disposed of with household waste. Please recycle where facilities exist. Check with your Local Authority or retailer for recycling advice.

