

# AFERIV

## Portable Power Station

AF-P110 | User Manual

1200W

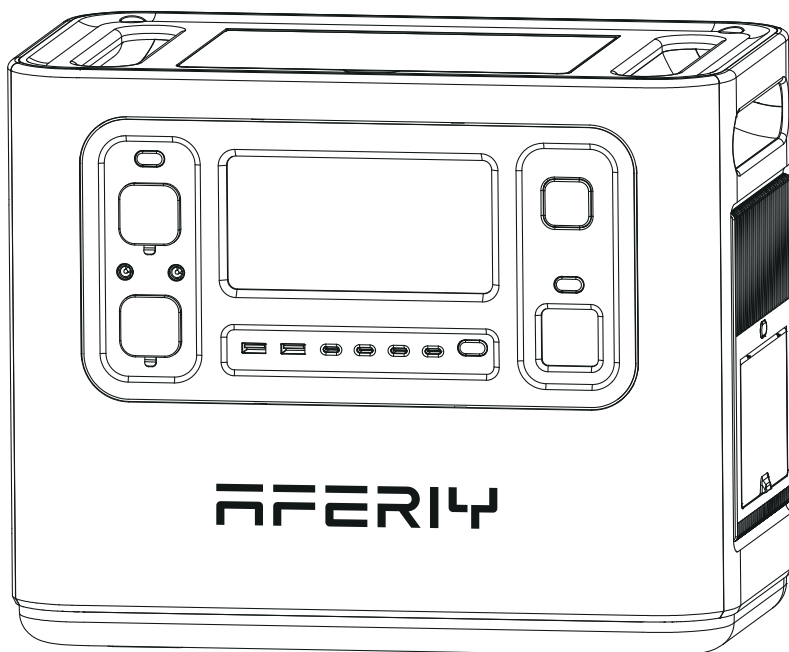

Hi dear, thank you very much for purchasing and experiencing the AF-P110 portable power station. Before operating this product, please carefully read the user manual for proper operation.

According to the transportation requirements of the international customs for battery products, the battery level of this product is only less than 35% when it leaves the factory. Please fully charge the product after unpacking it to start the experience tour of AF-P110.



## Precautions For Use

1. Please avoid long-term storage and use of this product in environments with high temperature and humidity or direct sunlight to avoid shortened battery life and other failures. The product should not be close to the fire source, otherwise it may cause a major fire or accident.
2. This product must not be disassembled or modified. Improper operation may cause product malfunction or even fire.
3. Be careful not to drop or drop the product from a high place, so as not to damage the product.
4. Please store or use this product out of the reach of children, otherwise the product may be dropped or collided and may cause bodily injury to children.
5. Please use our original accessories, and AFERIY will not guarantee the defective products caused by the use of non-original accessories.
6. Please directly plug in the wall socket to charge the product, do not use extension cords or cable taps, otherwise there is a risk of damage to the extension cords and cable taps or even a fire; If the extension socket is plugged in to charge this product, please do not connect other electrical appliances to this socket, otherwise the household meter may trip.
7. When the product is not in use or idle, please turn it off and unplug the power cable. If it needs to be idle for a long time, please consume the product from a fully charged state to an uncharged state, then recharge it to about 50% of the battery level and store it. In order to prolong the life of the product, please take three months as a cycle, operate and keep it in this way.
8. If the product reaches scrap conditions, please discard or recycle the product in accordance with local laws.

# Contents

- Packing List ..... 01
- Product Introduction..... 01
- Button Function Introduction..... 02
- Introduction of Display Interface..... 05
- Troubleshooting table..... 06
- UPS Mode ..... 07
- Connection of Solar Panels ..... 08
- Car Charging ..... 09
- Product Parameter ..... 10
- Battery Specifications..... 10
- Disclaimer ..... 11
- Warranty Card ..... 12

# Packing List



Portable Power Station



AC Charging Cable



User Manual



MC4 to XT90 Plug Charging Cable

## Product Introduction

This product is a portable power device with a built-in battery pack with charge/discharge function. It includes both AC output interface and DC output interface such as USB output, cigarette lighter output, DC output, etc. It also has functions such as display, interface control, protection, and alarm. Moreover, this product can be charged by mains AC, solar panels and vehicle charging.

The following are the main features of this product:

- Equipped with EVE brand LiFePo4 battery, the battery capacity is as high as 1248Wh, and the safety level is extremely high.
- 1200W pure sine wave AC output can meet almost all daily electronic equipment and small household appliances.
- Two-way fast charging technology is adopted to fully charge the product within 2 hours.
- A great variety of output interfaces such as USB-A, Type-C PD3.0, DC5521, XT60, cigarette lighter output, etc., meet many different application scenarios.
- In UPS mode, the switchover time is less than 10ms which is truly seamless switching.
- Multiple protection mechanisms such as battery, circuit, structure, etc., guarantee the product safety.



# Button Function Introduction

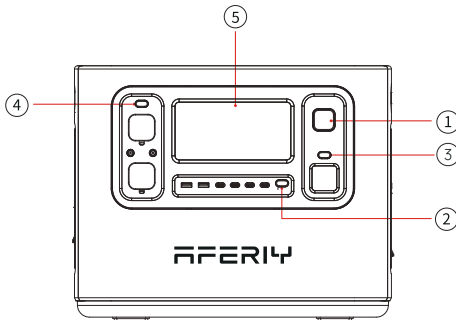

- ① Power ON/OFF Button
- ② USB ON/OFF Button
- ③ LED Light Button  
(Switch to different mode)
- ④ DC ON/OFF Button
- ⑤ LCD Screen

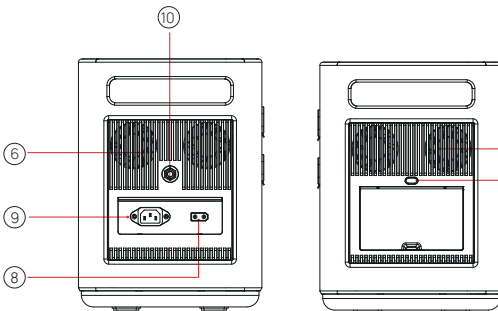



- ⑥ Cooling Air Duct
- ⑦ AC Button  
(manually switch to 50/60Hz)
- ⑧ XT90 Input Port  
( for solar panel)
- ⑨ AC input
- ⑩ Overload Protection Button

## ① Power ON/OFF Button

Instructions: Press and hold the power button for 3S to wake up the system, turn on the LCD display, and press and hold again for 3S to turn it off.

## ② USB ON/OFF Button

Instructions: Short press the USB button to turn on the USB output port, and short press again to turn it off.

		
USB-A X 2	TYPE-C X 3	TYPE-C X 1
QC 3.0	PD-20W	PD-100W

## ③ Light Button

Instructions: Short press the Light button, the LED lights are all on; short press again, the LED light enters the SOS mode, short press in turn, enter the strobe mode, and finally the LED light turns off ( LED in any mode , long press the light button for  $\geq 1$  second directly turn off the LED light).

#### 4 DC ON/OFF Button

Instructions: Short press the DC button to turn on the DC output port, and short press again to turn it off.

 Dcoutput X 2 12V/3A	 Cigarette port X 1 12V/10A	 XT60 X 1 12V/25A
---	--	--

#### 5 LCD Screen

Display the product's battery level and usage status tips.

#### 6 Cooling Suction/Exhaust Port

When the product reaches the temperature threshold set by the system, the cooling fan will automatically run, accompanied by a cert-ain fan noise (fan noise below 60dB is normal). Do not block the cooling suction/exhaust port during use of this product, and do not place any object within the range of 30CM.

#### 7 AC Button(AC output port, the sum of electrical load power should be <1200W)

Tap the AC button to enable the AC output function. Since there may be differences in the AC output frequency in different regions, if you need to switch the frequency, the operations are as follows: Press and hold the AC button for 2 seconds to enter the frequency switching mode, the 50Hz or 60Hz icon will flash on the display, short press the AC button again to select 50Hz or 60Hz; when the icon stops flashing and displays 50Hz or 60Hz, it indicates the switch is successful.

#### 8 XT90 Port

This interface supports solar panel input or car charger input. For details, please refer to "Solar Panel Connection" on page 9 of this manual and "Car Charging" on page 10.

#### 9 AC Input

To charge the product by a household socket can achieve 700W fast charging. It only takes 2 hours to fully charge from 0 to 100%. When charging in this way, please pay attention to the following points:

\* Please directly plug in the wall socket to charge the product, do not use extension cords or cable taps, otherwise there is a risk of damage to the extension cords and cable taps or even a fire.

\* If the extension socket is plugged in to charge this product, please do not connect other electrical appliances to this socket, otherwise the household meter may trip.

## **⑩ Overload Protection Button**

When the power supply current is unstable due to lightning or other reasons, and there is a large current input at the AC Input, in order to protect the product, the overload protection function (safety circuit breaker) will activate and cut off the AC input port.

Please follow the sequence below to restore the AC input function:

- 1) Turn off the power button and unplug all ports.
- 2) After confirming that there is no abnormality in each part, turn on the power button.
- 3) Press the overload protection button, connect the AC Cable to restore the AC input.

# Introduction of Display Interface

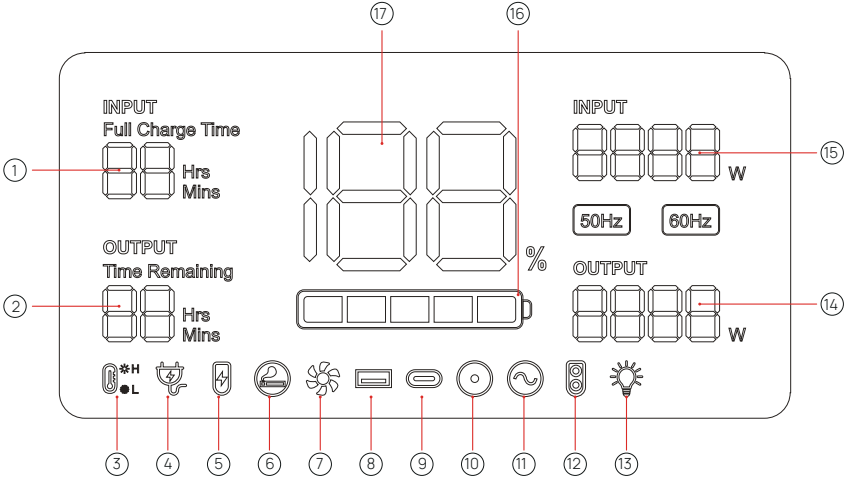

- |                                   |                              |                            |
|-----------------------------------|------------------------------|----------------------------|
| ① Recharging Time                 | ⑥ Cigar Lighter (12V) Output | ⑫ XT60 (12V) Output        |
| ② Remain Using                    | ⑦ Fan Status                 | ⑬ LED Light                |
| ③ High/Low Temperature Protection | ⑧ USB Output                 | ⑭ Output Power in Total    |
| ④ Connected to the AC Mains       | ⑨ PD3.0 Output               | ⑮ Input Power in Total     |
| ⑤ XT90 Input                      | ⑩ DC (12V) Output            | ⑯ Battery Progress Bar     |
|                                   | ⑪ AC Output                  | ⑰ Battery Level Percentage |



## Screen Display Description

Power display: When the product is in the charging state, the battery progress bar rotates continuously in the form of a clockwise marquee, and the battery level percentage gradually increases; when the product battery level is 0, the battery level percentage icon flashes.

Input and output status: When the product is working, the total input power, total output power and the cursor corresponding to the working area will be displayed on the screen.



# Troubleshooting Table

Phenomenon	Cause	Processing method
 <p>The above output icon flashes and beeps.</p>	The output exceeds the standard and it's short-circuited.	Remove the load, and then short press the switch in the area corresponding to the icon to remove the alarm
 <p>The temperature warning icon flashes and beeps.</p>	The temperature of the product is too high or too low.	Take the product out of the charging state, remove all loads, turn the power off, wait for the device to reach a suitable working temperature, then the alarm is removed.
 <p>The icon of connecting to the AC mains flashes and the product cannot be charged.</p>	The charging cable is poorly connected.	The overload protection function is enabled
	The overload protection function is activated	<ol style="list-style-type: none"> <li>1. Turn off the power button and unplug all ports</li> <li>2. After confirming that there are no faults in each part, turn the power switch back on.</li> <li>3. Press the overload protection button, connect the AC cable to restore the AC input</li> </ol>

If you have any questions, please feel free to contact us.

Email address: [support@aferiy.com](mailto:support@aferiy.com).

Sincerely,

# UPS Mode

- **UPS Feature**

This product has the function of backup uninterruptible power supply. The usage and operation precautions are as follows:

As shown in Pic 1 below, when the product is connected between the wall socket and the electrical appliance, and the power supply and AC switch of the product are in the ON state, the product enters the UPS working mode. The AC mains in the socket supplies power to the electrical appliance through the bypass circuit, and also charges the product. In this working state, the rated power of the electrical appliance must be lower than 1100W (only 100V-120V), otherwise overload protection may be triggered.

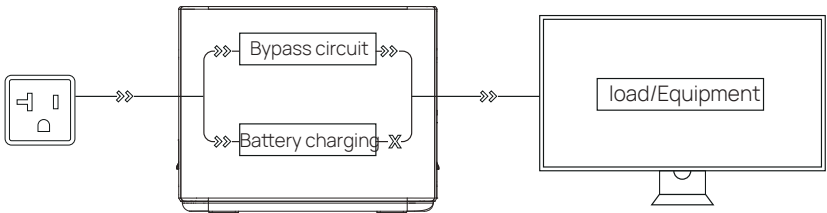

(Pic 1)

As shown in Pic 2 below, when the AC mains at the socket end is disconnected, the bypass output inside the product stops working, the product switches to a bidirectional inverter circuit within 10ms, and the circuit outputs supply power to the electrical appliance to ensure that the electrical appliance is uninterrupted and works normally during the process.

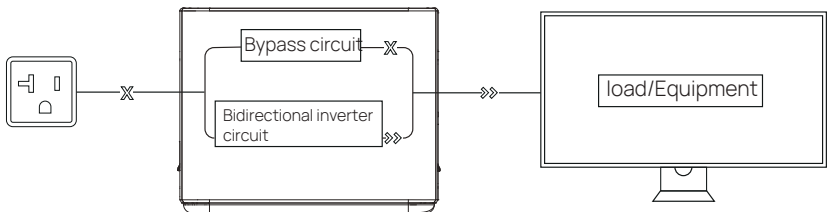

(Pic 2)

# Connection of Solar Panels

Under the condition of light, this product can be connected to the solar panel and getting charged. The charging power is determined according to the conditions of light and weather.

In this charging mode, we support solar panel input within 500W, and the input voltage cannot exceed 50V, otherwise the product abnormality caused by it will not be covered by the warranty.

- We recommend the following two charging schemes:

## Scheme One

Portable Power Station Charging Area

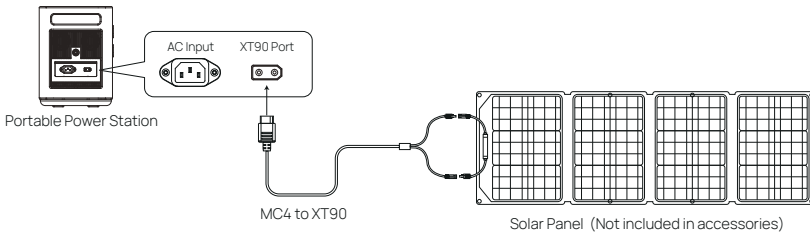

## Scheme Two

Portable Power Station Charging Area

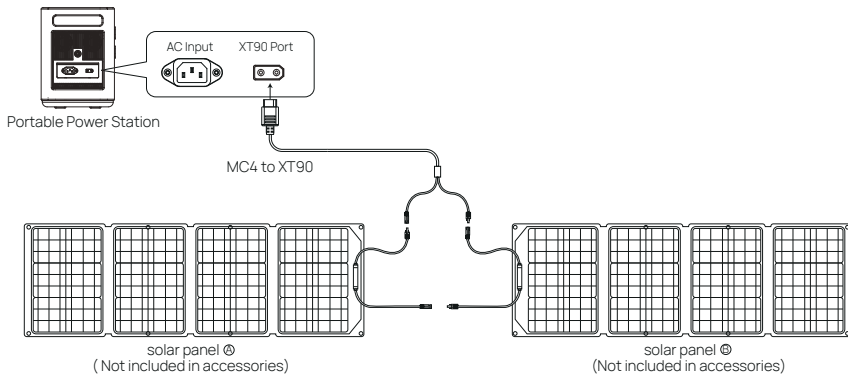

# Car Charging

When the car is in the process of starting, connect the car charging port on the car and the product through the car charging cable to charge the product. The connection method is shown in the picture below:

This product supports 12V/24V car charger charging, please pay attention to the following two points when using this method to charge:

- ※ Please use it when the car started, otherwise the car battery may be exhausted.
- ※ Vehicle charging power is usually in the range of 90W-120W, and the charging time is long. If fast charging is required, the AC mains charging is recommended.

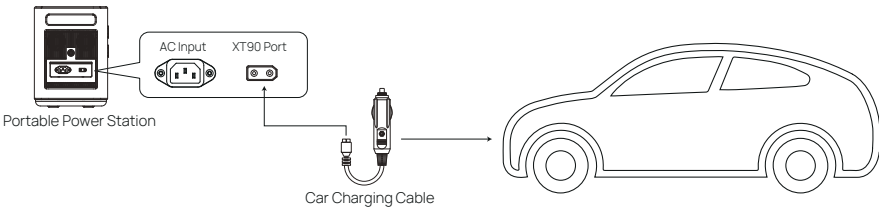

# Product Parameter

Product Name	1200W Portable Power Station
Dimension	L*W*H=392X230X315mm
Weight	15.5kg
Capacity	1248Wh
AC Charging	AC Mains Input, 700W max
XT90 Input	11.5-50V 20A below 500W max
AC Output	50/60Hz (switchable), rated 1200W, pure sine wave with overload, short circuit protection
USB-A Output	(QC3.0 18W)X2
Type-C ① Output	(PD20W) X3
Type-C ② Output	(PD100W) X1 Included PD3.0 protocol
DC 5521 Output	12V/3AX2
XT-60 Output	12V/25A
Car Charging Output	12V/10A
Shutdown Current	< 500uA
Working Temperature	-10~40°C
Environment Humidity	≤90%RH
Cycle Times	> 3500 times

# Battery Specifications

Cell type	32130 LiFePo4
Rated voltage of single battery	3.2V
Rated capacity of single battery	13Ah
Rated voltage of battery pack	48V
Output voltage range of the battery pack	42-54V
Rated capacity of battery pack	1248Wh

# Disclaimer

Before use, please read the user manual of this product to ensure full understanding and correct use. After reading, keep the user manual properly for future reference. If you do not operate this product correctly, you could cause serious injury to yourself or others, or result in damage to the product and property. Once you use this product, you are deemed to have understood, recognized and accepted all terms and content of this document. Users undertake to be responsible for their own actions and all consequences arising therefrom. AFERIY is not responsible for all losses caused by the user's failure to use the product in accordance with the User Manual.

In compliance with the law, the company has the final right to interpret this document and all related documents of the product. If it is updated, revised or terminated without prior notice, please visit the AFERIY official website for the latest product information.

# Warranty Card

Warranty Card	
Model	
Name	
Address	
Tel	
Mail	
Name of the store	
Buying date	
Please fill in all the above items.	

## **This product provides a 24-month warranty service from the date of purchase**

- If there is a quality problem within the range of normal use, we provide warranty service.
- After purchasing our company's products, please keep this product together with invoices and other items. When maintenance services are needed, please provide information according to our company's request.
- In the case where the warranty is damaged or altered, and no stamp of the sales store on the warranty, the warranty service may not be provided.
- Damage caused by use beyond the normal range of use is not covered by the warranty service.
- The content of the warranty scope shall be subject to the content recognized by the company.
- Even within the scope of the warranty, sometimes it will be exchanged for products with the same function. The shipping and repair fees for products outside the warranty range shall be paid by the customer.
- Sometimes the specifications and functions of the product will be updated without prior notice.