

**RayBit**

# TB5 All-in-One 4K AI Video Bar



User Manual

zoom

Certified

# CONTENT

US	-----	01
DE	-----	07
FR	-----	13
ES	-----	19
IT	-----	25
CN	-----	31

# Package contents

---

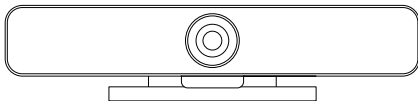

TB5 All-in-One 4K AI Video Bar X 1



Remote control X 1



USB 2.0 To Type C Adapter X 1

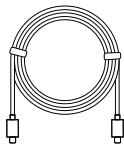

Type-C cable X 1

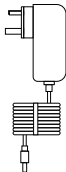

Power adapter X 1



User manual X 1

# Overview

---

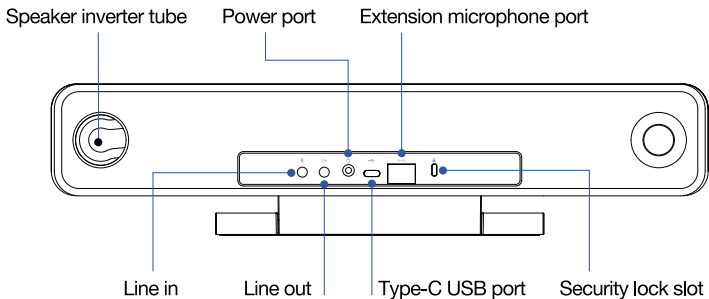
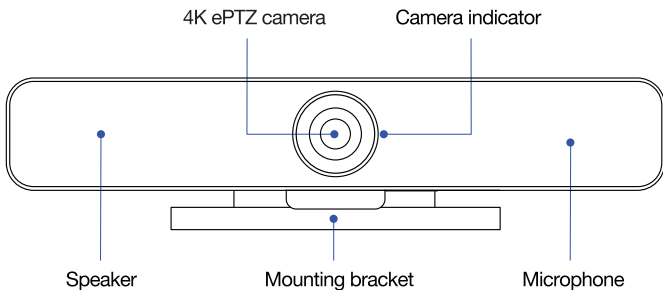

# Easy Set-up

Connect TB5 camera to PC/conference host via USB cable, and connect PC/conference host to TV screen via HDMI cable.

1

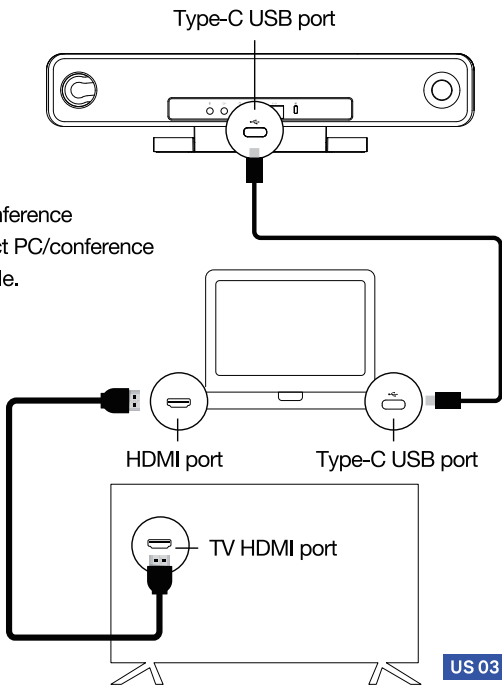

Mounting bracket

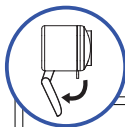

2

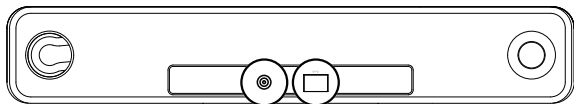

3



Power adapter

Extension microphone  
(Optional)



# 4

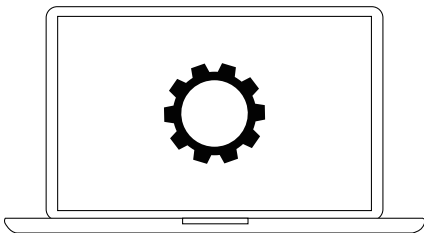

In the settings of the computer and conference software, select the device for the camera, microphone and speaker.

## Camera indicator light status

When the camera program is on or running, the camera light is blue.

When the microphone is muted, the camera light is red. Other normal conditions the camera light is green.

## Camera preset settings

Adjust the camera's field of view to the desired preset position, press and hold the 1 (or 2, 3) button for about 2 seconds, you can hear the prompt tone, and the preset position is successfully set.

Repeat the above steps, press 1, 2, 3 key respectively, you can set 3 preset positions in sequence.

Pressing the same key will overwrite the previous preset and update it with the latest preset.

# Camera remote control

---

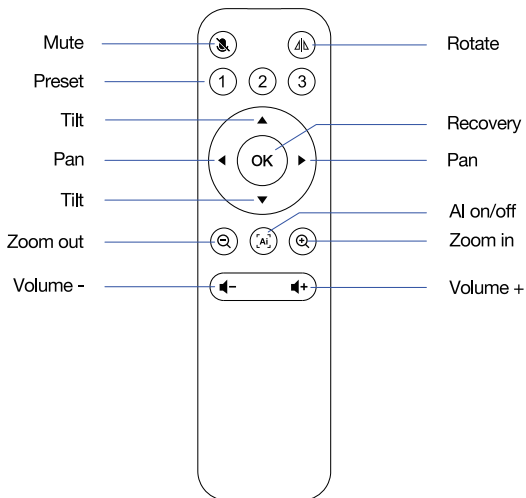

## Note:

1. Button "AI": One Button can switch auto framing mode, speaker tracking mode, and manual mode.
2. Button "1、2、3": Camera Preset: Press and hold it until you hear "do do do". (On Manual Mode)
3. The 6X digital zoom functionality: Zoom in/out. (On Manual Mode)
4. Button "Rotate": Support 360° rotation of the screen. (On Manual Mode).
5. The remote requires two (2) AAA batteries. (Batteries Not Included).



# Packungsinhalt

---

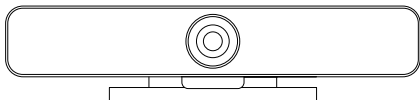

TB5 All-in-One-Konferenzkamera X 1



Fernbedienung X 1



USB 2.0-auf-Typ-C-Adapter X 1

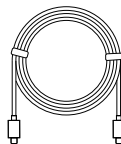

Typ-C-Datenkabel X 1

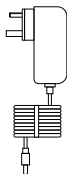

Netzteil X 1

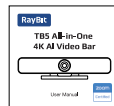

Schnellstartanleitung X 1

# Produktbeschreibung

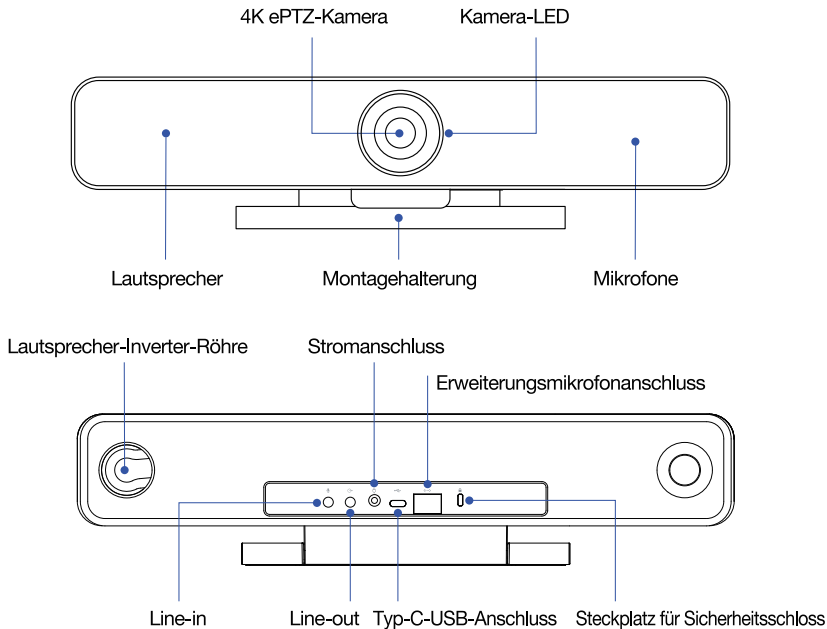

# Schnelle und einfache Einrichtung

Schließen Sie die TB5-Kamera über ein USB-Kabel an den PC/Konferenz-Host an und verbinden Sie den PC/Konferenz-Host über ein HDMI-Kabel mit dem Fernsehbildschirm.

1

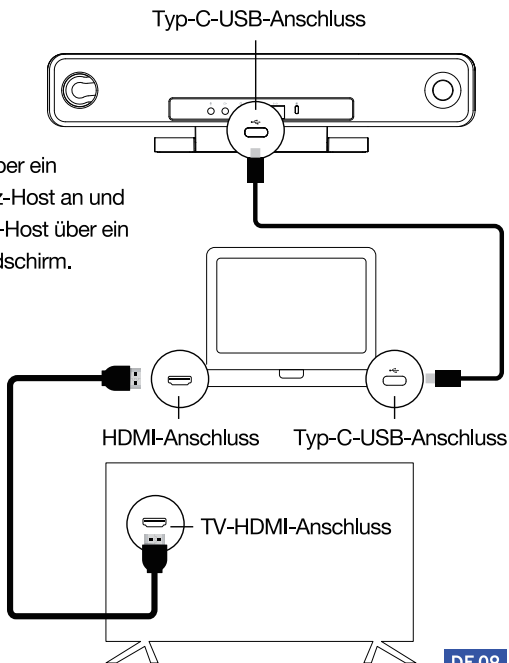

Montagehalterung

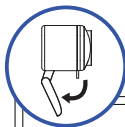

2

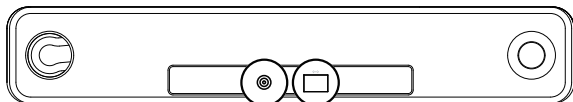

3



Netzteil

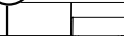

Erweiterungsmikrofon  
(Optional)

# 4

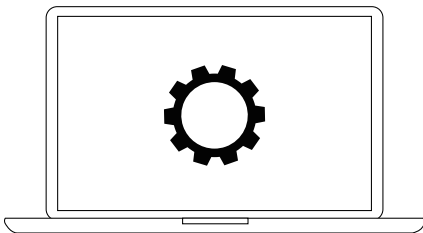

Wählen Sie in den Einstellungen der Computer- und Konferenzsoftware das Gerät für Kamera, Mikrofon und Lautsprecher des TB5 aus.

## Status der Kamera-LED

Wenn das Kameraprogramm eingeschaltet ist oder ausgeführt wird, leuchtet das Kameralicht blau. Wenn das Mikrofon stummgeschaltet ist, leuchtet das Kameralicht rot. Unter anderen normalen Bedingungen ist das Kameralicht grün.

## Voreinstellungen der Kamera

Stellen Sie das Sichtfeld der Kamera auf die gewünschte voreingestellte Position ein, halten Sie die Taste 1 (oder 2, 3) etwa 2 Sekunden lang gedrückt, Sie hören den Aufforderungston und die voreingestellte Position ist erfolgreich eingestellt.

Wiederholen Sie die obigen Schritte, drücken Sie jeweils die Tasten 1, 2, 3, Sie können 3 voreingestellte Positionen nacheinander einstellen.

Durch Drücken derselben Taste wird das vorherige Preset überschrieben und mit dem neuesten Preset aktualisiert.

# Kamera-Fernbedienung

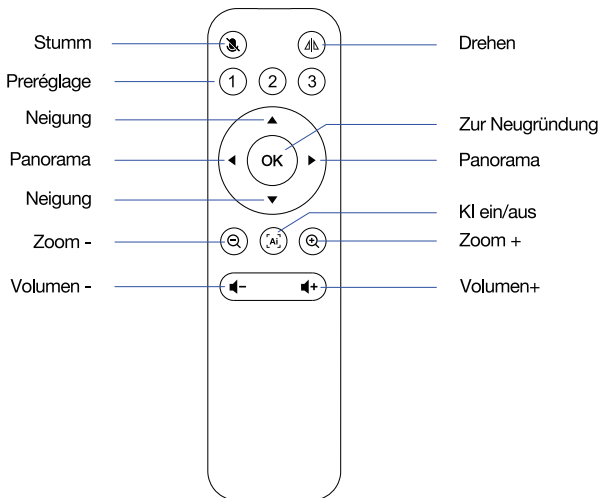

## Hinweis:

1. Taste "AI": Eine Taste kann den Auto-Framing-Modus, den Lautsprecher-Tracking-Modus und den manuellen Modus umschalten.
2. Taste "1、 2、 3 ": Kamera-Voreinstellung: Halten Sie sie gedrückt, bis Sie "do do do" hören. (Im manuellen Modus)
3. Die 6-fache Digitalzoomfunktion: Vergrößern / Verkleinern. (Im manuellen Modus)
4. Schaltfläche "Drehen": Unterstützt die 360°-Drehung des Bildschirms. (Im manuellen Modus).
5. Die Fernbedienung benötigt zwei (2) AAA-Batterien. (Batterien nicht im Lieferumfang enthalten).

# Contenu de l'emballage

---

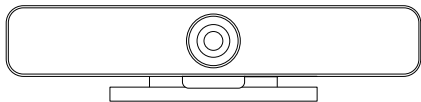

Caméra de conférence tout-en-un X 1



Télécommande X 1



Adaptateur USB 2.0 vers type C X 1

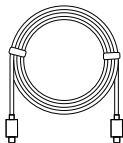

Câble de données de type C X 1

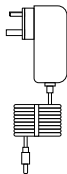

Adaptateur secteur X 1

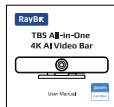

Guide d'installation rapide X 1

# Description du produit

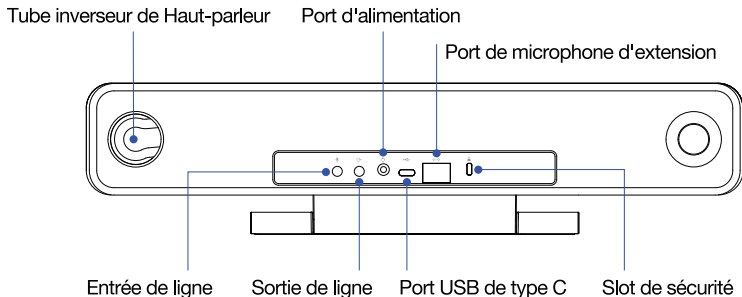
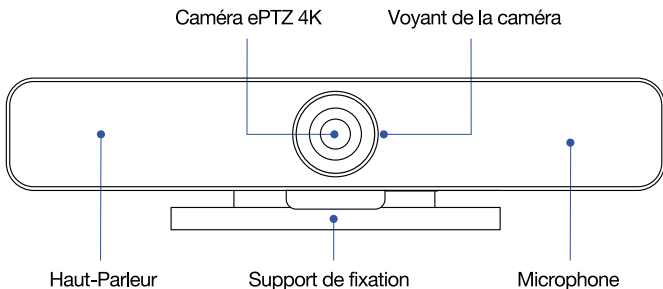



# Installation rapide et facile

Connectez la caméra TB5 au PC/hôte de conférence via un câble USB, et connectez le PC/hôte de conférence à l'écran de TV via un câble HDMI.

1

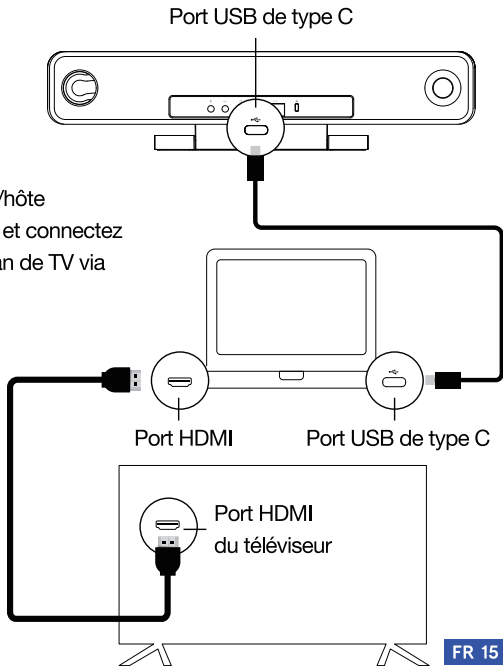

Support de fixation

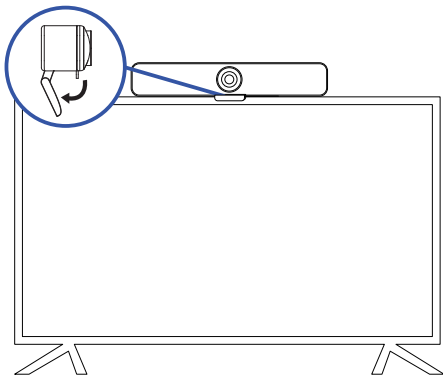

2

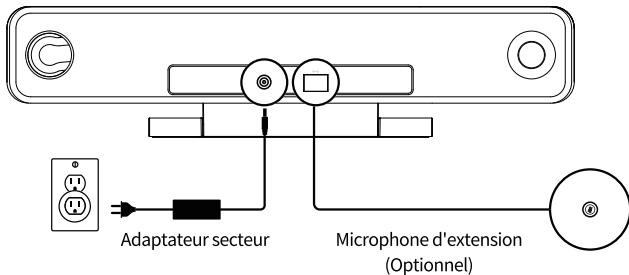

3

# 4

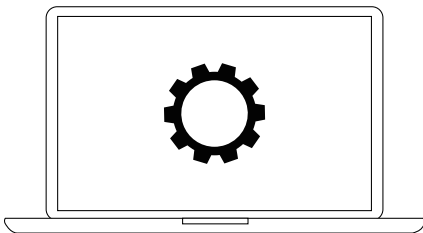

Dans les paramètres de l'ordinateur et du logiciel de conférence, sélectionnez l'appareil pour la caméra TB5, le microphone et le haut-parleur.

## État du voyant de la caméra

Lorsque le programme de la caméra est activé ou en cours d'exécution, le voyant de la caméra est bleu. Lorsque le microphone est coupé, le voyant de la caméra est rouge. Dans d'autres conditions normales, le voyant de la caméra est vert.

## Paramètres prédéfinis de la caméra

Ajustez le champ de vision de la caméra à la position prédéfinie souhaitée, maintenez enfoncé le bouton 1 (ou 2, 3) pendant environ 2 secondes, vous pouvez entendre la tonalité d'invite et la position prédéfinie est réglée avec succès.

Répétez les étapes ci-dessus, appuyez sur les touches 1, 2, 3 respectivement, vous pouvez définir 3 positions prédéfinies en séquence.

Appuyez la même touche écrasera le préréglage précédent et le mettra à jour avec le dernier préréglage.

# Télécommande de caméra

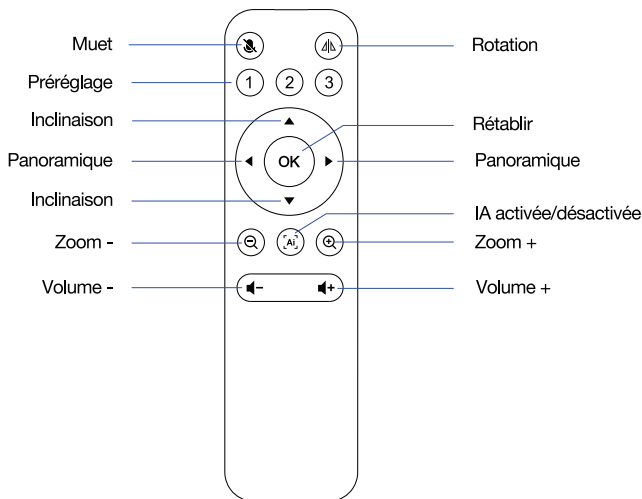

## Remarque :

1. Bouton « AI » : Un bouton peut changer de mode de cadrage automatique, de mode de suivi des haut-parleurs et de mode manuel.
2. Bouton « 1、 2、 3 »: Préréglage de la caméra: Appuyez dessus et maintenez-le enfoncé jusqu'à ce que vous entendiez « do do do ». (En mode manuel).
3. La fonctionnalité de zoom numérique 6X: Zoom avant / arrière. (En mode manuel).
4. Bouton « Rotation »: Prise en charge de la rotation à 360 ° de l'écran. (En mode manuel).
5. La télécommande nécessite deux (2) piles AAA. (Piles non incluses).

# Contenidos del paquete

---

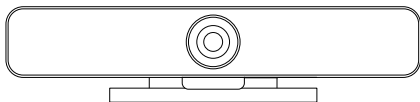

TB5 Cámara de conferencias todo en uno X 1



Mando a distancia X 1



Adaptador USB 2.0 a tipo C X 1

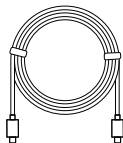

Cable de datos tipo C X 1

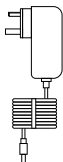

Adaptador de corriente X 1

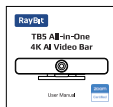

Guía de instalación rápida X 1

# Descripción del producto

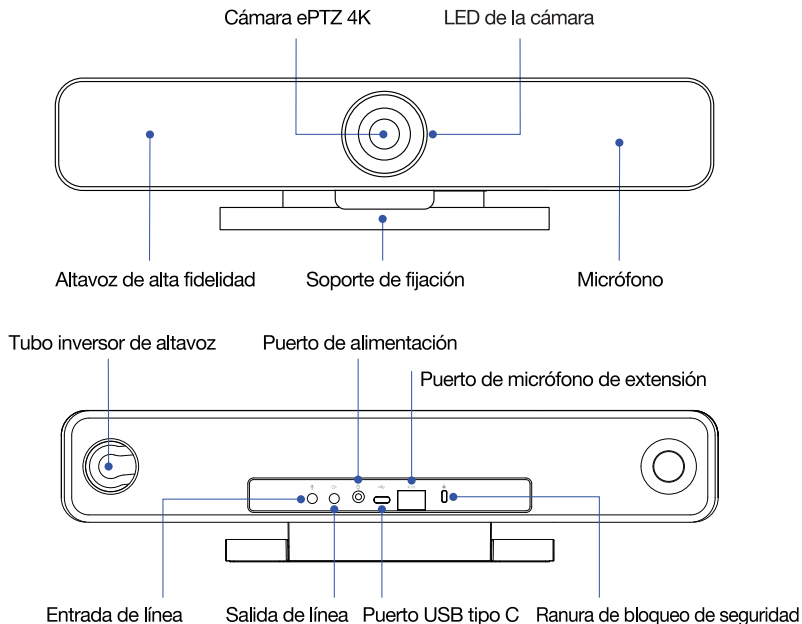

# Configuración rápida y sencilla

Conecte la cámara TB5 a la PC/anfitrión de la conferencia con un cable USB y conecte la PC/anfitrión de la conferencia a la pantalla del televisor con un cable HDMI.

1

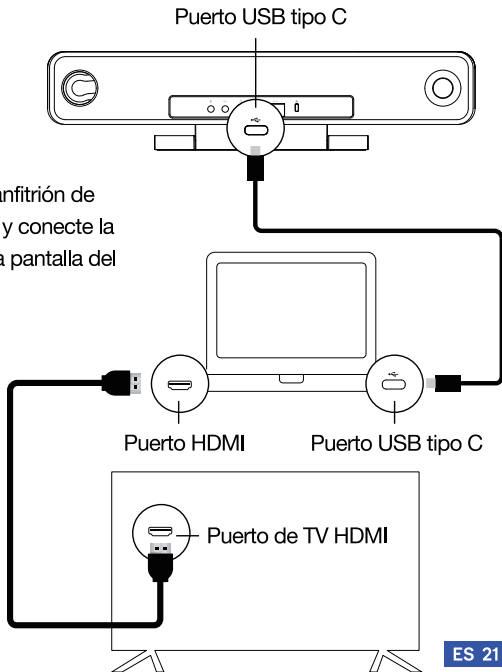

Soporte de montaje

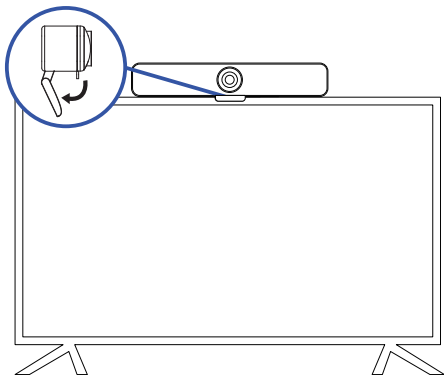

2

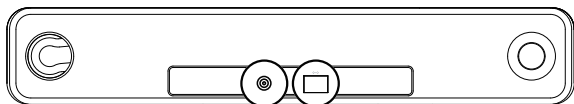

3



Adaptador de corriente

Puerto de extensión de micrófono (Opcional)  
o de micrófono de extensión





# 4

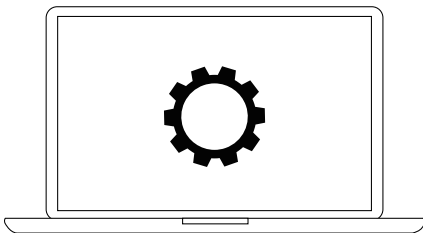

En la configuración de la computadora y el software de conferencias, seleccione el dispositivo para la cámara, el micrófono y el altavoz TB5.

## Estado del LED de la cámara

Cuando el programa de la cámara está encendido o en ejecución, la luz de la cámara es azul. Cuando el micrófono está silenciado, la luz de la cámara es roja. Otras condiciones normales la luz de la cámara es verde.

## Configuración preestablecida de la cámara

Ajuste el campo de visión de la cámara a la posición preestablecida deseada, mantenga presionado el botón 1 (o 2, 3) durante aproximadamente 2 segundos, puede escuchar el tono de aviso y la posición preestablecida se establece correctamente.

Repita los pasos anteriores, presione la tecla 1, 2, 3 respectivamente, puede configurar 3 posiciones preestablecidas en secuencia.

Presionar la misma tecla sobrescribirá el preajuste anterior y lo actualizará con el último preajuste.

# Mando a distancia de la cámara

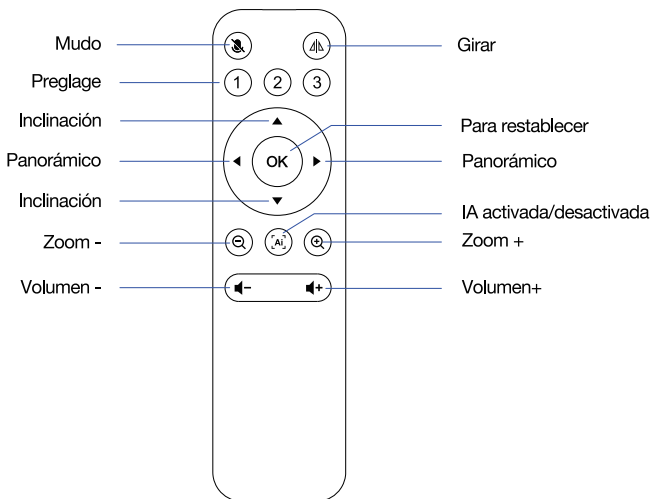

## Nota:

1. Botón "AI": Un botón puede cambiar el modo de encuadre automático, el modo de seguimiento de altavoces y el modo manual.
2. Botón "1, 2, 3": Ajuste preestablecido de la cámara: Manténgalo presionado hasta que escuche "do do do". (en modo manual).
3. La funcionalidad de zoom digital 6X: acercar / alejar. (en modo manual).
4. Botón "Rotar": admite la rotación de 360 ° de la pantalla. (en modo manual).
5. El control remoto requiere dos (2) pilas AAA. (pilas no incluidas).

# Contenuto della confezione

---

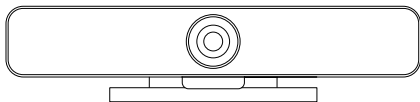

TB5 Videocamera per conferenze All-in-One X 1



Telecomando X 1



Adattatore da USB 2.0 a tipo C X 1

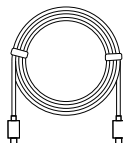

Cavo dati di tipo C X 1

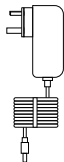

Adattatore di alimentazione X 1

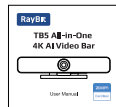

Guida rápida X 1

# Descrizione del prodotto

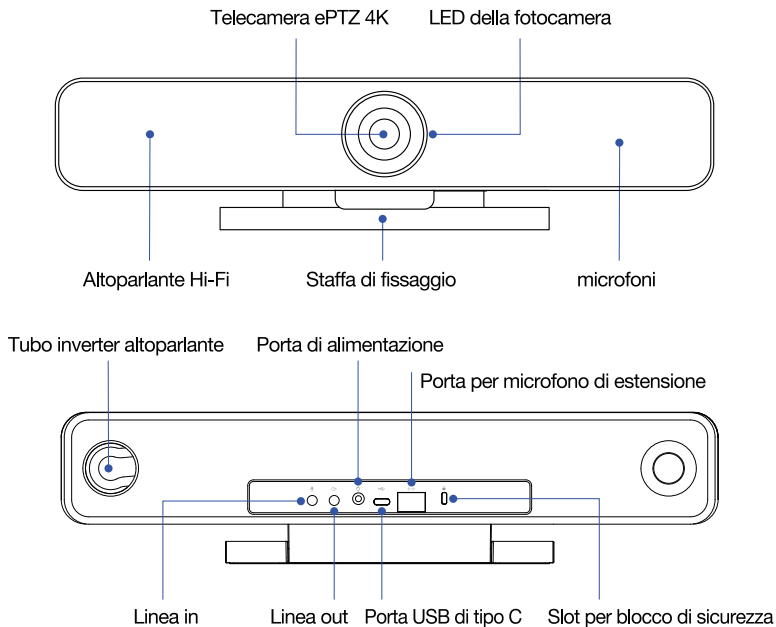

# Configurazione rápida e semplice

Collega la videocamera TB5 al PC/conferenza host tramite cavo USB e collega il PC/conferenza host allo schermo TV tramite cavo HDMI.

1

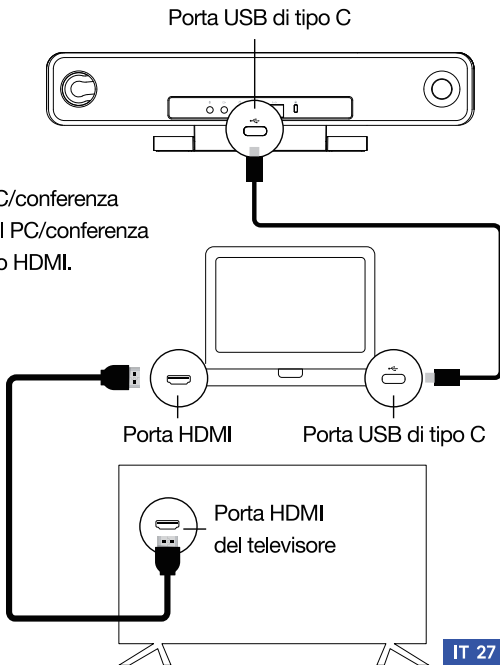

Staffa di fissaggio

2

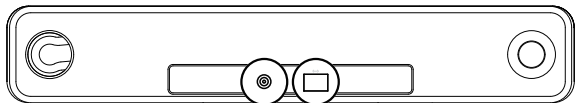
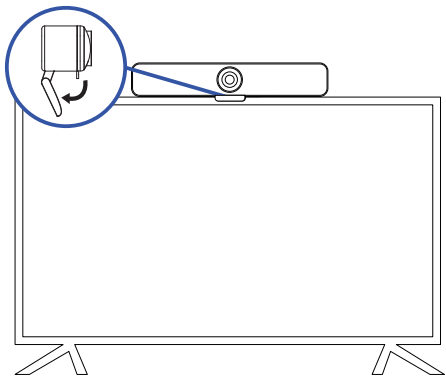

3



Adattatore di alimentazione

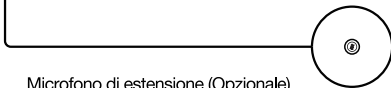

Microfono di estensione (Opzionale)

# 4

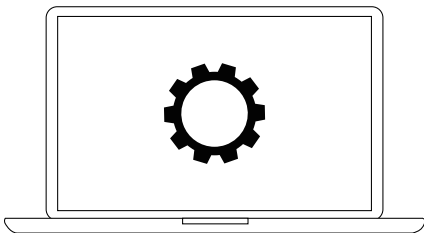

Nelle impostazioni del computer e del software per conferenze, seleziona il dispositivo per la videocamera, il microfono e l'altoparlante TB5.

## Stato del LED della telecamera

Quando il programma della fotocamera è attivo o in esecuzione, la luce della fotocamera è blu. Quando il microfono è disattivato, la luce della fotocamera è rossa. In altre condizioni normali, la luce della fotocamera è verde.

## Impostazioni predefinite della fotocamera

Regolare il campo visivo della telecamera sulla posizione preimpostata desiderata, premere e tenere premuto il pulsante 1 (o 2, 3) per circa 2 secondi, è possibile ascoltare il segnale acustico e la posizione preimpostata è stata impostata correttamente.

Ripetere i passaggi precedenti, premere rispettivamente i tasti 1, 2, 3, è possibile impostare 3 posizioni preimpostate in sequenza.

Premendo lo stesso tasto si sovrascriverà il preset precedente e lo si aggiornerà con l'ultimo preset.

# Telecomando della fotocamera

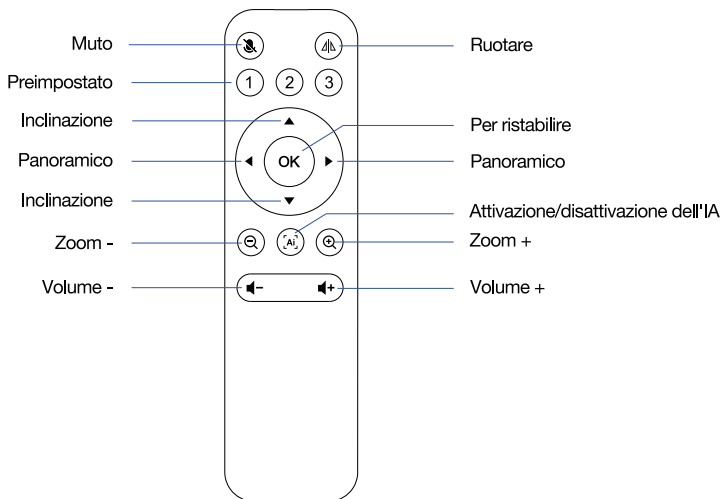

## Nota:

1. Pulsante "AI": un pulsante può cambiare la modalità di inquadratura automatica, la modalità di tracciamento degli altoparlanti e la modalità manuale.
2. Pulsante "1、 2、 3": Preset fotocamera: Tieni premuto finché non senti "do do do". (In modalità manuale).
3. La funzionalità di zoom digitale 6X: zoom in / out. (In modalità manuale).
4. Pulsante "Ruota": supporta la rotazione a 360 ° dello schermo. (In modalità manuale).
5. Il telecomando richiede due (2) batterie AAA. (Batterie non incluse).



# 包装清单

---

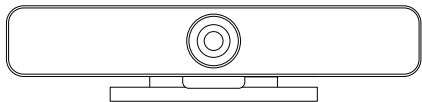

4K智能会议摄像机 X 1



遥控器 X 1



转接头 X 1

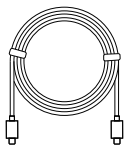

Type-C 数据线 X 1

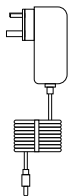

电源适配器 X 1

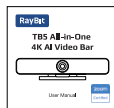

用户手册 X 1

# 产品概况

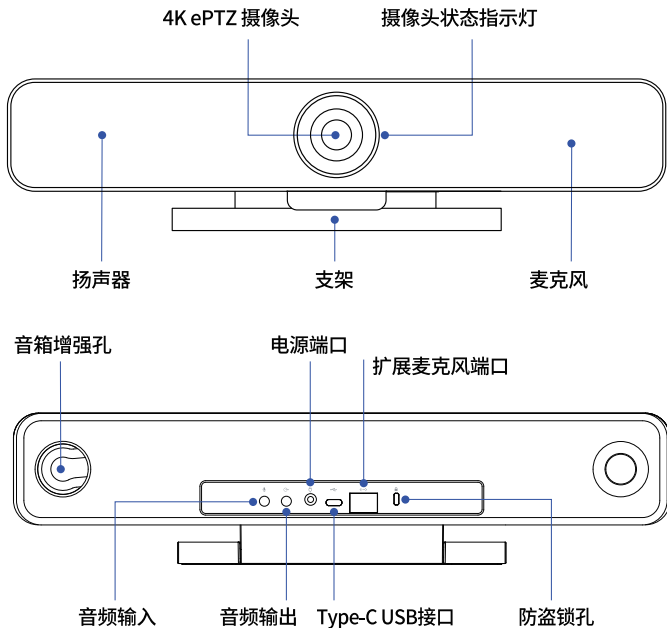

# 快速安装指南

通过USB线将TB5会议摄像机连接到电脑主机上，  
然后使用HDMI线连接主机和屏幕。

1

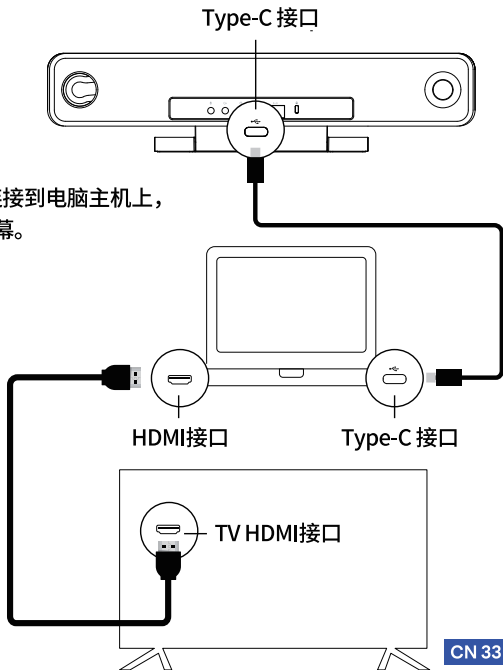

2

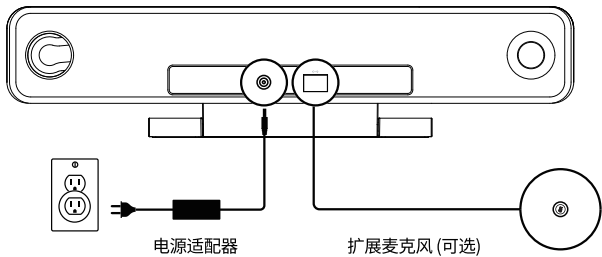
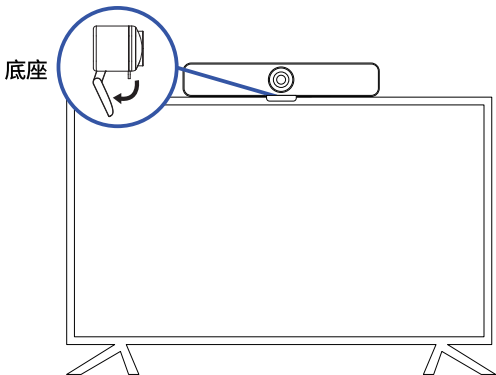

# 4

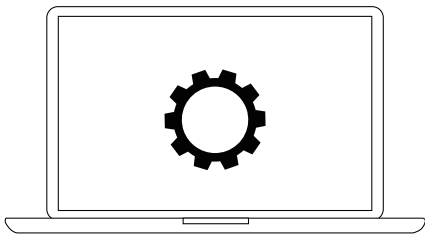

在电脑和会议软件设置中，摄像头，麦克风和喇叭分别选中此设备。

## 摄像头指示灯状态

当摄像头程序打开或者运行时，摄像头指示灯为蓝色。当麦克风静音时，摄像头指示灯为红色。其他正常情况下为绿色。

## 预设位设置

摄像头视野调至想要的预设方位，长按1（或者2，3）键2秒左右，即可听到提示音，此时预设位设置成功。重复以上步骤，分别按1，2，3键，可以依次设置3个预设位。重复同一个按键会覆盖此前的预设位，更新为最新的预设位。

# 摄像机遥控器

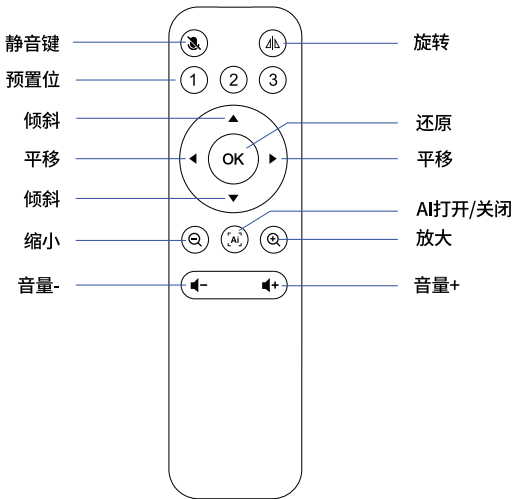

## 注意：

1. 按钮“AI”：一个按钮可以切换自动取景模式，扬声器跟踪模式和手动模式。
2. 按钮“1、2、3”：相机预设：按住它直到听到“do do do”。(手动模式)
3. 六倍数码变焦功能：放大/缩小。(手动模式)。
4. 按钮“旋转”：支持屏幕360°旋转。(在手动模式下)。
5. 遥控器需要两 (2) 节 AAA 电池。(不包括电池)。

# RayBit

---

**Website:** [www.raybit.com](http://www.raybit.com)

**E-mail:** [amazon03@raybit.com](mailto:amazon03@raybit.com)

 @RayBit

**EU**

**REP**

## **SUCCESS COURIER SL**

CALLE RIO TORMES NUM.1, PLANTA 1, DERECHA,  
OFICINA 3, Fuenlabrada, Madrid, 28947 Spain

**UK**

**REP**

## **GOAL REACH CONSULTING LTD**

OFFICE 1029 3 HARDMAN STREET 10TH FLOOR,  
SPINNINGFIELDS MANCHESTER, UK M3 3HF



FR

Cet appareil  
et ses accessoires  
se recyclent

À DÉPOSER  
EN MAGASIN



OU

À DÉPOSER  
EN DÉCHÈTERIE



Points de collecte sur [www.quefairedemesdechets.fr](http://www.quefairedemesdechets.fr)



FR

ÉTUI



**RoHS**



# RayBit



RayBit Service Team  
[www.raybit.com](http://www.raybit.com)