

RayBit

SC1 Live Streaming Camera

User Manual



CONTENT

US	-----	01
DE	-----	09
FR	-----	17
ES	-----	25
IT	-----	33
CN	-----	41

WHAT'S IN THE BOX

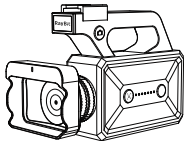

Live Streaming Camera X 1



User Manual X 1



USB Cable X 1

OVERVIEW

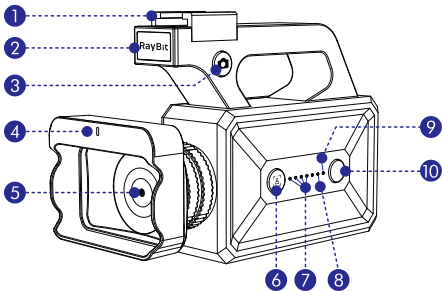

1. Cold Shoe Clamp

2. Live Streaming Indicator

(Working hours: White
Live time: Red)

3. Take Photo/ Video

4. AI indicator

5. FULL HD Camera

6. AI ON/OFF

7. Battery indicator

8. WiFi indicator

9. Wireless connection indicator

10. Wireless connection

(No such function yet, The wireless connection is enabled by default at power-on.)

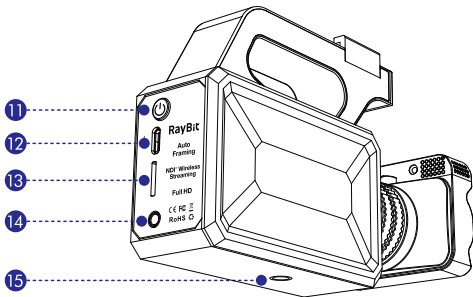

11. Power

12. Type-C Port

13. Micro SD Slot

14. 3.5mm audio port (Line in/Mic in)

15. 1/4 UNC threaded hole

EASY SET-UP

1. If there is a bracket, Install it on the bracket through the screw hole at the bottom of the camera.

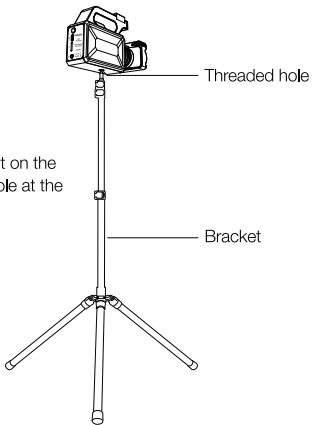

2. Press the power button for 3 seconds to start up.
The startup is complete when the indicator light stops flashing.



3. The wireless connection button has no function for now, and the wireless connection function is enabled by default when the device is turned on.
(When the mobile phone is not connected to SC1, the wireless connection indicator flashes, When the wireless connection is connected, the wireless connection light is always on.)

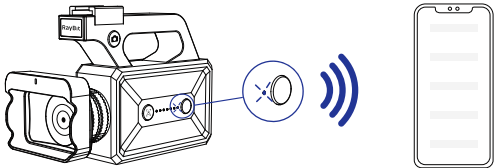

3.1 Search for 'raybit' or 'studiocam' on the Apple Store or Google Play, download and open the RayBit StudioCam app.

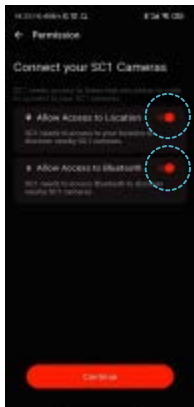

Step 1: Click Allow access to location, After accessing Bluetooth, proceed to the next step.



Step 2: discovery of SC1 devices, to set it up.

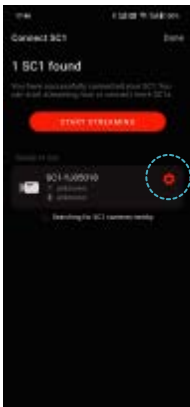

Step 3: Set up WiFi.

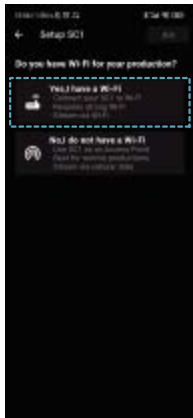

Step 4: Connect to WiFi.

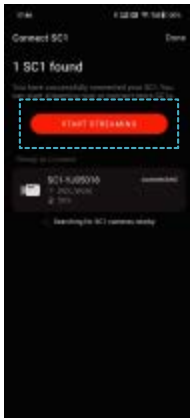

Step 5: Click "Start IStreaming" button, and then enter the live broadcast interface.

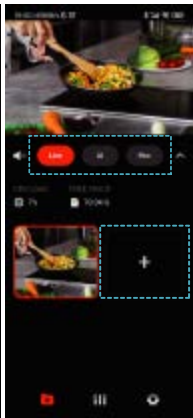

Step 6: Click the live button to start Live, you can add more by "+" SC1 is live.
(Temporarily only supports Facebook, YouTube Live Platform).

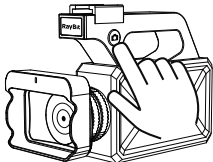

4. Short press the camera button to take a photo,
Long press to start video recording.

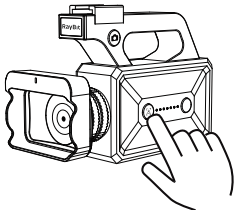

5. Press "AI" button to turn on camera AI face tracking function.

CHARGE

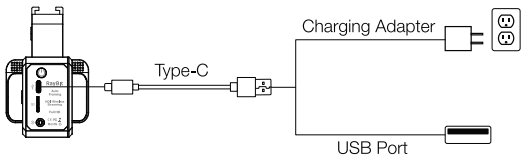

US 08

PACKUNGSIHALT

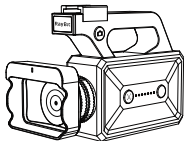

Live-Streaming-Kamera X 1

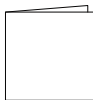

Schnellstartanleitung X 1



USB-Kabel X 1

PRODUKTBESCHREIBUNG

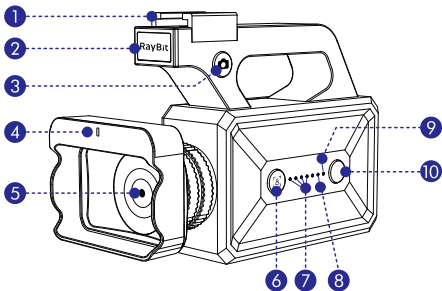

1. Cold-Shoe-Halterung

2. Live-Streaming-Kontrollleuchte

(Beim Arbeiten: weiß
Wenn live: Rot)

3. Foto/Video aufnehmen

4. AI-Indikator

5. FULL-HD-Kamera

6. AI EIN / AUS

7. Betriebs-LED

8. Wifi-Anzeiger

9. WLAN-Verbindungsanzeige

10. Drahtlose Verbindung

(Es gibt noch keine solche Funktion,
Die drahtlose Verbindung ist beim
Einschalten standardmäßig aktiviert.)

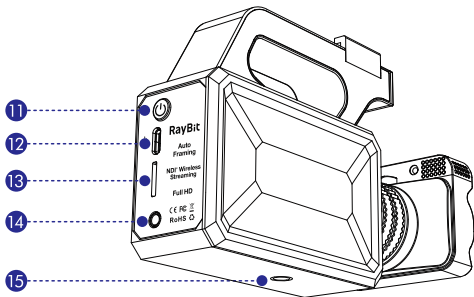

11. Stromschalter

12. Typ-C-Anschluss

13. Micro-SD-Steckplatz

14. 3,5-mm-Audioanschluss
(Line-Eingang/Mikrofon-Eingang)

15. 1/4 UNC Gewindebohrung

SCHNELLE UND EINFACHE EINRICHTUNG

1. Wenn eine Klammer vorhanden ist, Befestigen Sie die Kamera durch die Schraubenlöcher an der Unterseite der Kamera an der Halterung.

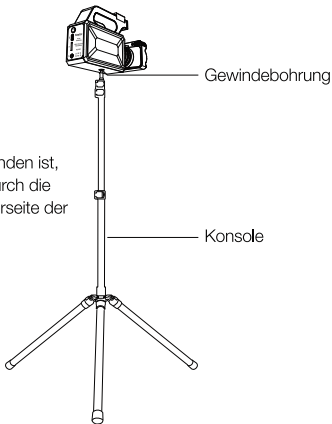

2. Um den Computer zu starten, halten Sie die Ein / Aus-Taste 3 Sekunden lang gedrückt. Der Startvorgang ist abgeschlossen, wenn die Anzeige aufhört zu blinken.

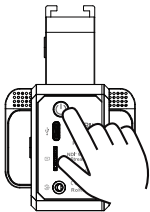

3. Die Taste für die drahtlose Verbindung hat derzeit keine Funktion und die Funktion für die drahtlose Verbindung ist standardmäßig aktiviert, wenn das Gerät eingeschaltet wird. (Wenn das Mobiltelefon nicht mit SC1 verbunden ist, blinkt die Anzeige für die drahtlose Verbindung. Wenn die drahtlose Verbindung hergestellt ist, leuchtet die LED für die drahtlose Verbindung immer.)

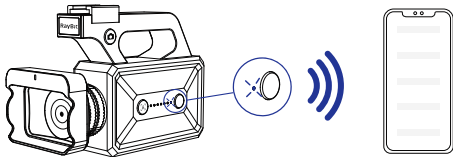

3.1 Suchen Sie im Apple Store oder Google Play nach "RayBit" oder "StudioCam" und laden Sie die RayBit StudioCam App herunter und öffnen Sie sie.

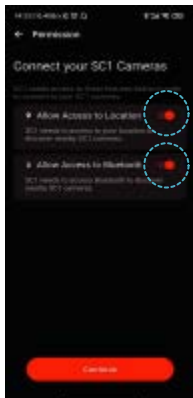

Step 1: Klicken Sie auf Zugriff auf Standort zulassen. Nachdem Sie auf Bluetooth zugegriffen haben, fahren Sie mit dem nächsten Schritt fort.



Step 2: Die App sucht automatisch nach SC1-Kameras in der Nähe.

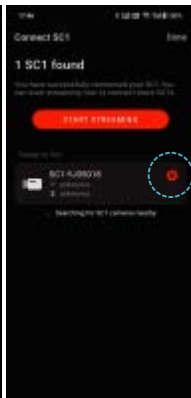

Step 3: Setzen Sie WiFi ein.

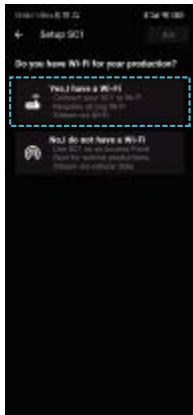

Step 4: Mit WiFi verbinden.

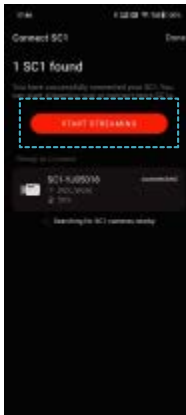

Step 5: Klicken Sie auf die Schaltfläche "Start streaming", um die Live-Übertragungsoberfläche aufzurufen.

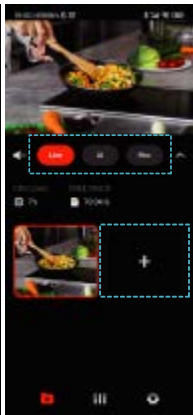

Step 6: Klicken Sie zum Starten auf die Live-Schaltfläche Live können Sie per "+" weitere hinzufügen. SC1 ist live. (Unterstützt vorübergehend nur Facebook, YouTube Live-Plattform).

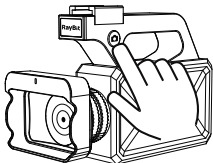

4. Appuyez brièvement sur le bouton de l'appareil photo pour prendre une photo, Appuyez longuement pour démarrer l'enregistrement vidéo.

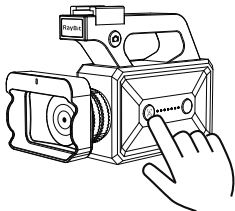

5. Drücken Sie die AI-Taste, um die automatische Verfolgung des AI-Porträts der Kamera zu starten.

BERECHNEN

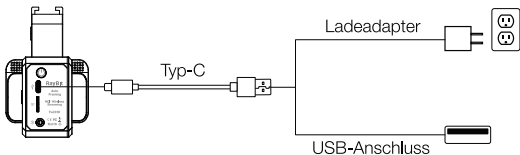

CONTENU DE L'EMBALLAGE

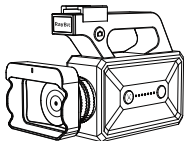

Caméra en direct X 1



Guide d'installation rapide X 1



Câble USB X 1

DESCRIPTION DU PRODUIT

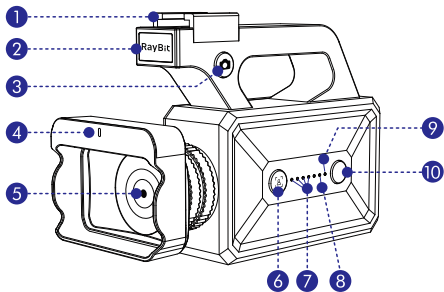

1. Pince de griffe froide
2. Voyant de diffusion en direct
(En fonctionnement : blanc
Lorsqu'il est en direct : rouge)
3. Prendre une photo/vidéo
4. Indicateur AI
5. Caméra FULL HD

6. IA ACTIVÉ/DÉSACTIVÉ
7. LED d'alimentation
8. Indicateur WiFi
9. Voyant de connexion sans fil
10. Connexion sans fil
(Il n'y a pas encore une telle fonction,
La connexion sans fil est activée par
défaut à la mise sous tension.)

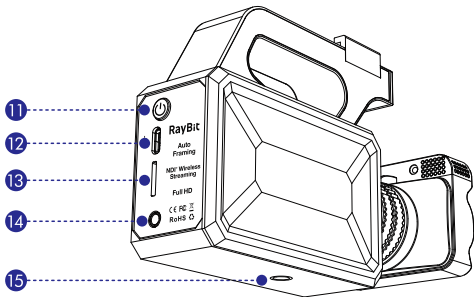

11. Interrupteur d'alimentation

12. Port de type C

13. Emplacement Micro SD

14. Port audio 3,5 mm

(Entrée ligne/Entrée micro)

15. 1/4 de trou fileté UNC

INSTALLATION RAPIDE ET FACILE

1. S'il y a un support, Fixez-le au support à travers les trous de vis situés sous l'appareil photo.

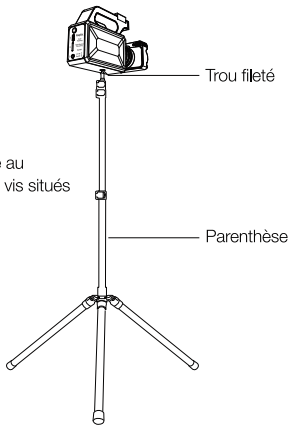

2. Pour démarrer, appuyez sur le bouton d'alimentation pendant 3 secondes. Lorsque le voyant cesse de clignoter, le démarrage est terminé.

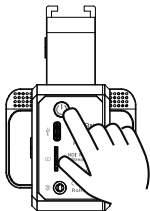

3. Le bouton de connexion sans fil n'a aucune fonction pour le moment et la fonction de connexion sans fil est activée par défaut lorsque l'appareil est allumé. (Lorsque le téléphone mobile n'est pas connecté à SC1, le voyant de connexion sans fil clignote, Lorsque la connexion sans fil est établie, le voyant de connexion sans fil est toujours allumé.)

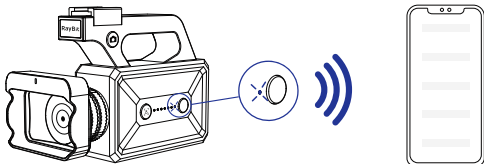

3.1 Après avoir recherché "raybit" ou "studiocam" sur l'Apple Store ou Google Play, téléchargez et ouvrez l'application RayBit StudioCam.

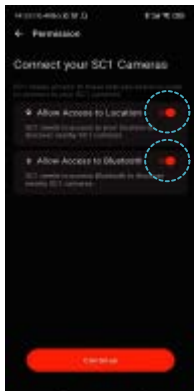

Step 1: Cliquez sur Autoriser l'accès à l'emplacement, accédez au Bluetooth et passez à l'étape suivante.



Step 2: App automatiquement recherche les caméras SC1 à proximité.

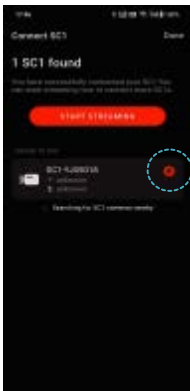

Step 3: Configurer le WiFi.

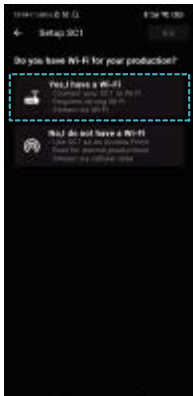

Step 4: Connecter au WiFi.

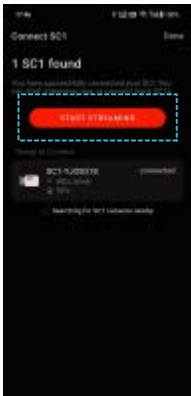

Step 5: Cliquez sur le bouton "Start Streaming" pour accéder à l'interface de diffusion en direct.

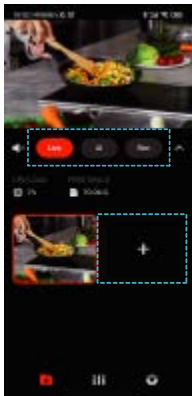

Step 6: Klicken Sie zum Starten auf die Live-Schaltfläche Live können Sie per "+" weitere hinzufügen. SC1 ist live.
(Unterstützt vorübergehend nur Facebook, YouTube Live-Plattform).

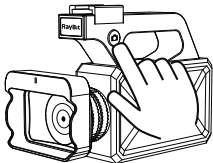

4. Appuyez brièvement sur le bouton de l'appareil photo pour prendre une photo, Appuyez longuement pour démarrer l'enregistrement vidéo.

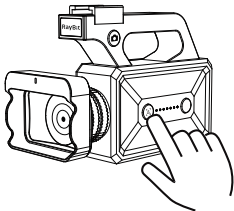

5. Appuyez sur le bouton AI pour démarrer le suivi automatique du portrait AI de l'appareil photo.

CHARGER

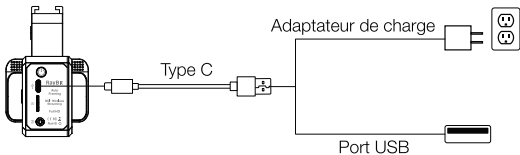

CONTENIDOS DEL PAQUETE

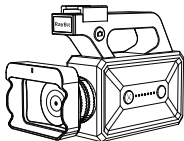

Cámara de transmisión en vivo X 1



Manual de usuario X 1



USB Cable X 1

DESCRIPCIÓN DEL PRODUCTO

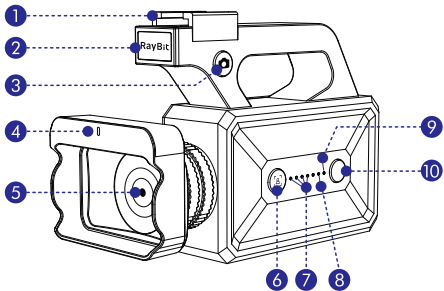

- 1. Abrazadera de zapata fría**
- 2. Indicador de streaming**
(Cuando se trabaja: Blanco
Durante la transmisión en vivo: Rojo)
- 3. Tomar foto/video**
- 4. Indicador de IA**
- 5. Cámara FULL HD**

- 6. IA ACTIVADA / DESACTIVADA**
- 7. LED de encendido**
- 8. Indicador WiFi**
- 9. Indicador de conexión inalámbrica**
- 10. Conexión inalámbrica**
(Todavía no existe tal función, La conexión inalámbrica está habilitada de forma predeterminada al encender.)

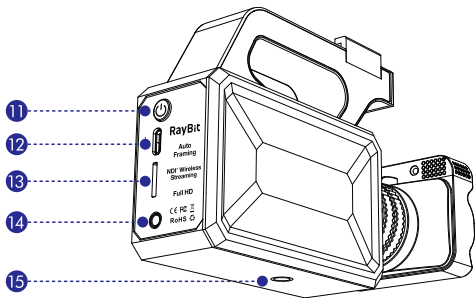

11. Interruptor de encendido

12. Puerto tipo C

13. Ranura Micro SD

14. Puerto de audio de 3,5 mm
(Entrada de línea/entrada de micrófono)

15. 1/4 de orificio roscado UNC

CONFIGURACIÓN RÁPIDA Y SENCILLA

1. Si hay un soporte, Fije al soporte a través de los orificios de los tornillos en la parte inferior de la cámara.

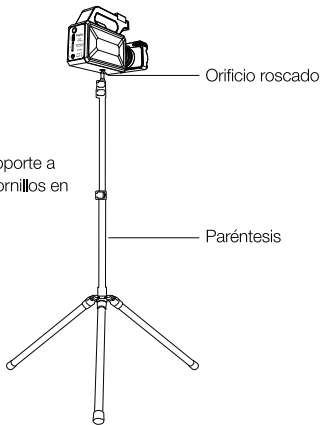

2. Para encender, mantenga presionado el botón de encendido durante 3 segundos y espere a que la luz indicadora deje de parpadear para que se complete el arranque.

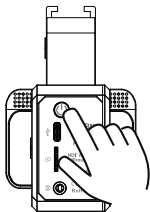

3. El botón de conexión inalámbrica no tiene ninguna función por ahora, y la función de conexión inalámbrica está habilitada de forma predeterminada cuando se enciende el dispositivo.

(Cuando el teléfono móvil no está conectado a SC1, el indicador de conexión inalámbrica parpadea. Cuando la conexión inalámbrica está conectada, la luz de conexión inalámbrica siempre está encendida.)

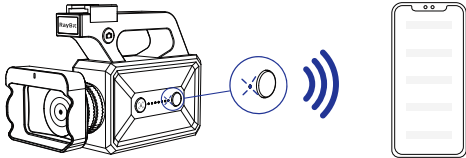

3.1 Descargue y abra la aplicación RayBit StudioCam buscando 'raybit' o 'studiocam' en Apple Store o Google Play

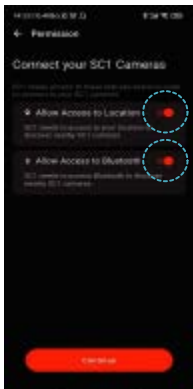

Step 1: Haga clic en Permitir acceso a la ubicación, acceda a Bluetooth y continúe con el siguiente paso.



Step 2: La aplicación busca automáticamente cámaras SC1 cercanas.

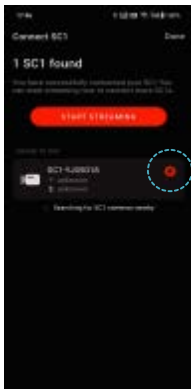

Step 3: Configurar WiFi.



Step 4: Conectar WiFi.

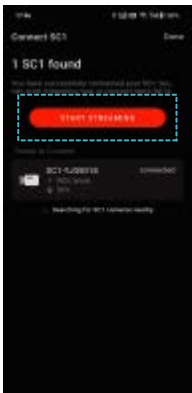

Step 5: Haga clic en el botón "Start Streaming" para ingresar a la interfaz de transmisión en vivo.

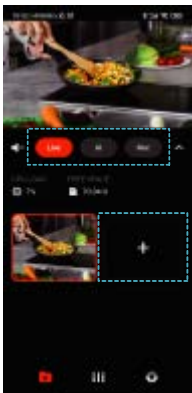

Step 6: Haga clic en el botón en vivo para comenzar En vivo, puedes agregar más con "+" SC1 está en vivo.
(Temporalmente solo es compatible con Facebook, plataforma de YouTube en vivo).

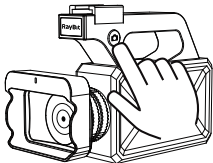

4. Presione brevemente el botón de la cámara para tomar una foto, Mantenga pulsado para iniciar la grabación de vídeo.

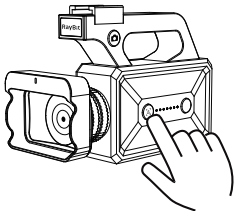

5. Presione el botón AI para iniciar el seguimiento automático del retrato AI de la cámara.

CARGO

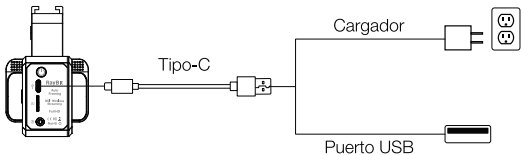

CONTENUTO DELLA CONFEZIONE

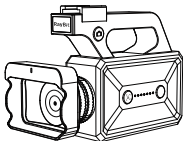

Telecamera in diretta streaming X 1



Guida rápida X 1



Cavo USB X 1

DESCRIZIONE DEL PRODOTTO

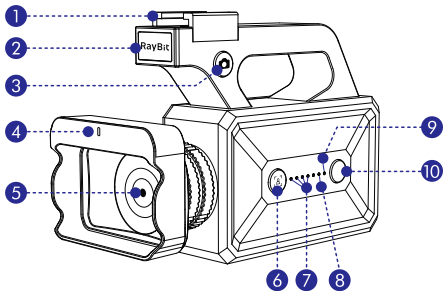

1. Morsetto per scarpe fredde

2. Indicatore di streaming

(Quando si lavora: Bianco)

Durante la trasmissione in diretta: Rosso)

3. Scatta foto / video

4. Indicatore AI

5. Telecamera FULL HD

6. AI ON/OFF

7. LED di alimentazione

8. Indicatore WiFi

9. Indicatore di connessione wireless

10. Connessione wireless

(Non esiste ancora tale funzione, La connessione wireless è abilitata per impostazione predefinita all'accensione.)

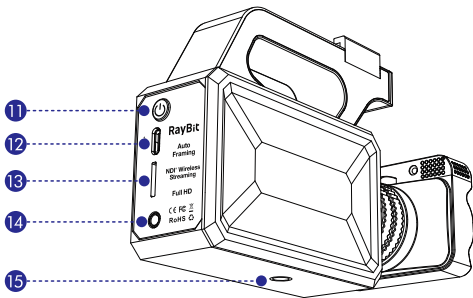

11. Interruttore di alimentazione

12. Porta di tipo C

13. Micro SD Slot

**14. Porta audio da 3,5 mm
(Line in/Mic in)**

15. 1/4 Foro filettato UNC

CONFIGUAZIONE RÁPIDA E SEMPLICE

1. Se è presente una parentesi, Fissare alla staffa attraverso i fori delle viti nella parte inferiore della fotocamera.

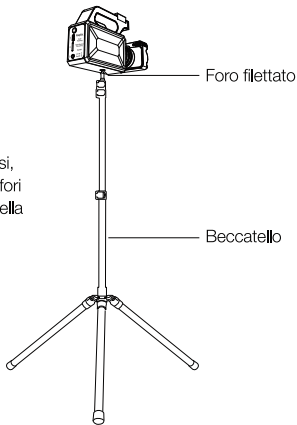

2. Premere il pulsante di accensione per 3 secondi per accendere il dispositivo. L'avvio è completato quando la luce indicatrice smette di lampeggiare.

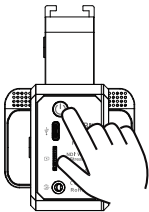

3. Il pulsante di connessione wireless non ha alcuna funzione per ora e la funzione di connessione wireless è abilitata per impostazione predefinita quando il dispositivo è acceso.

(Quando il telefono cellulare non è connesso a SC1, l'indicatore di connessione wireless lampeggia, Quando la connessione wireless è attiva, la spia della connessione wireless è sempre accesa.)

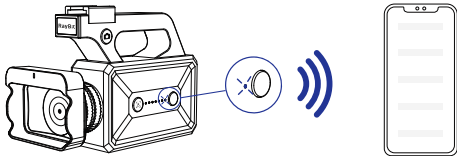

3.1 Si prega di cercare "raybit" o "studiocam" sull'Apple Store o su Google Play, scaricare e aprire l'app RayBit StudioCam.

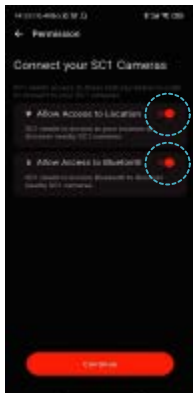

Step 1: Fai clic su Consenti accesso alla posizione, accedi al Bluetooth e procedi al passaggio successivo.



Step 2: App cerca automaticamente le telecamere SC1 nelle vicinanze.

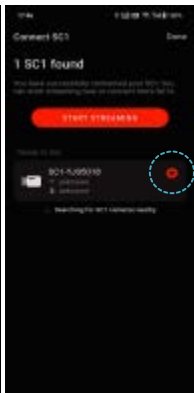

Step 3: Configurare il WiFi.

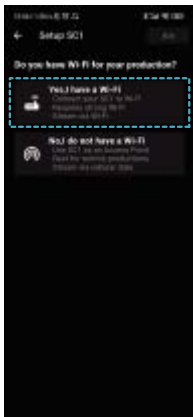

Step 4: Connettersi al WiFi.

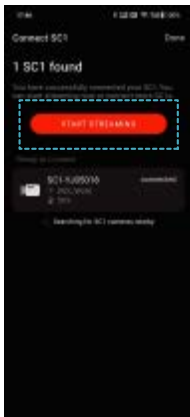

Step 5: Fare clic sul pulsante "Live Streaming" per accedere all'interfaccia di trasmissione live.

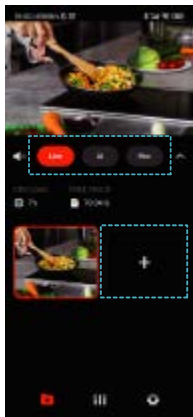

Step 6: Fai clic sul pulsante live per iniziare Dal vivo, puoi aggiungere altro con "+" SC1 è in diretta. (Supporta temporaneamente solo Facebook,piattaforma live di YouTube).

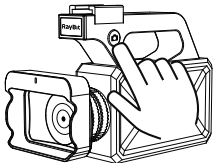

4. Premi brevemente il pulsante della fotocamera per scattare una foto, Premere a lungo per avviare la registrazione video.

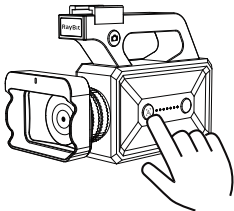

5. Premere il pulsante AI per avviare il tracciamento automatico dei ritratti AI della fotocamera.

ACCUSA

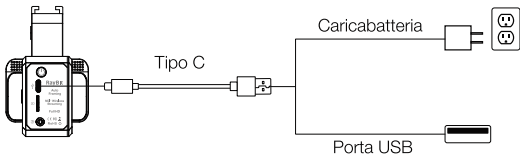

包装清单



直播摄像机 X 1



用户手册 X 1



USB 数据线 X 1

产品概览

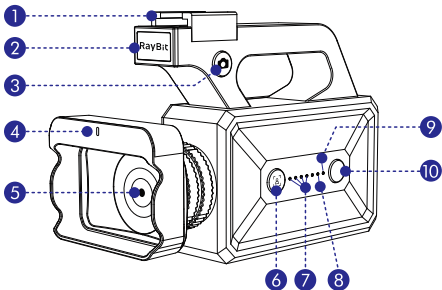

1. 冷靴座

2. 直播指示灯
(工作时:白色,
直播时:红色)

3. 拍摄键

4. AI状态指示灯

5. 全高清摄像头

6. AI 开启/关闭

7. 电量指示灯

8. Wi-Fi 指示灯

9. 无线连接指示灯

10. 无线连接(暂无此功能,
开机无线连接默认开启。)

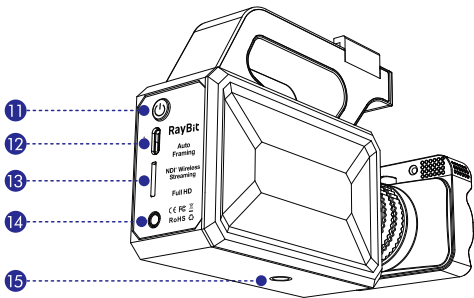

11. 电源开关

12. Type-C 接口

13. Micro SD 接口

14. 3.5mm音频口(Line in/Mic in)

15. 1/4 UNC螺纹孔

快速安装指南

1. 如果有支架，可通过相机底部的螺丝孔安装到支架上。

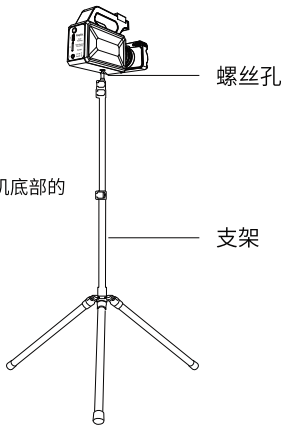

- 2.按电源按键3秒后开机，
当指示灯停止闪烁后启动完成。

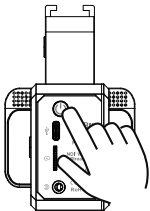

- 3.无线连接按钮暂无功能，开机默认启动无线连接功能。
(手机未连接SC1时，无线连接指示灯闪烁，
已连接无线连接时，无线连接指示灯常亮。)

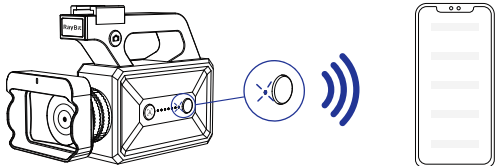

3.1 通过Apple store或者Google play搜索“raybit”或者“studiocam”下载并打开 RayBit StudioCam App:



Step 1: 点击允许访问位置、访问蓝牙后进行下一步。



Step 2: App自动搜索附近SC1摄像头。



Step 3: 设置WiFi。



Step 4: 连接WiFi。



Step 5: 点击开始直播按钮, 进入直播界面。

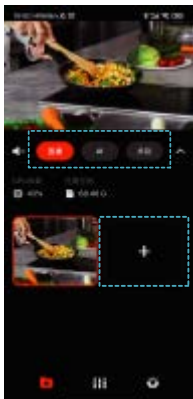

Step 6: 点击直播按钮开始直播, 通过“+”可以添加更多SC1进行直播。(暂时只支持Facebook、YouTube直播平台)。

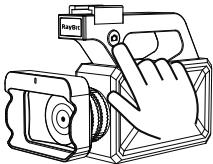

4. 短按拍照键可拍摄照片，
长按开启视频录制。

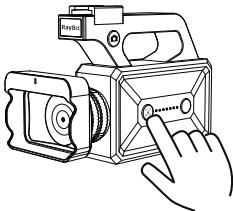

5. 按AI按键启动摄像头
AI人像自动跟踪。

充电方式

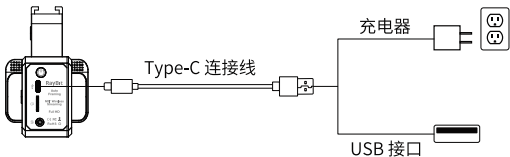

RayBit

Website: www.raybit.com

E-mail: amazon03@raybit.com

 @RayBit

EU

REP

SUCCESS COURIER SL

CALLE RIO TORMES NUM.1, PLANTA 1, DERECHA,
OFICINA 3, Fuenlabrada, Madrid, 28947 Spain

UK

REP

GOAL REACH CONSULTING LTD

OFFICE 1029 3 HARDMAN STREET 10TH FLOOR,
SPINNINGFIELDS MANCHESTER, UK M3 3HF



FR

Cet appareil
et ses accessoires
se recyclent

À DÉPOSER
EN MAGASIN



OU

À DÉPOSER
EN DÉCHÈTERIE



FR

ÉTUI



Points de collecte sur www.quefairedemesdechets.fr



RoHS





RayBit Service Team
www.raybit.com

Search for 'raybit' or 'studiocam' to download the RayBit StudioCam app.



Download on the
App Store



GET IT ON
Google Play