

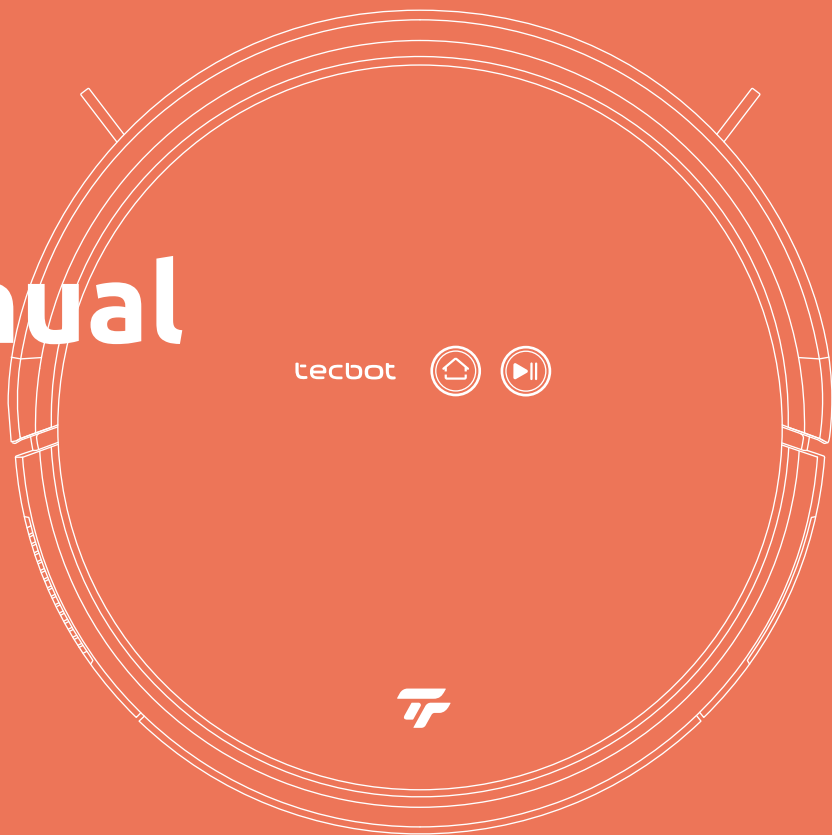

User Manual

TECBOT S1 Series





TECBOT S1 Series

User Manual

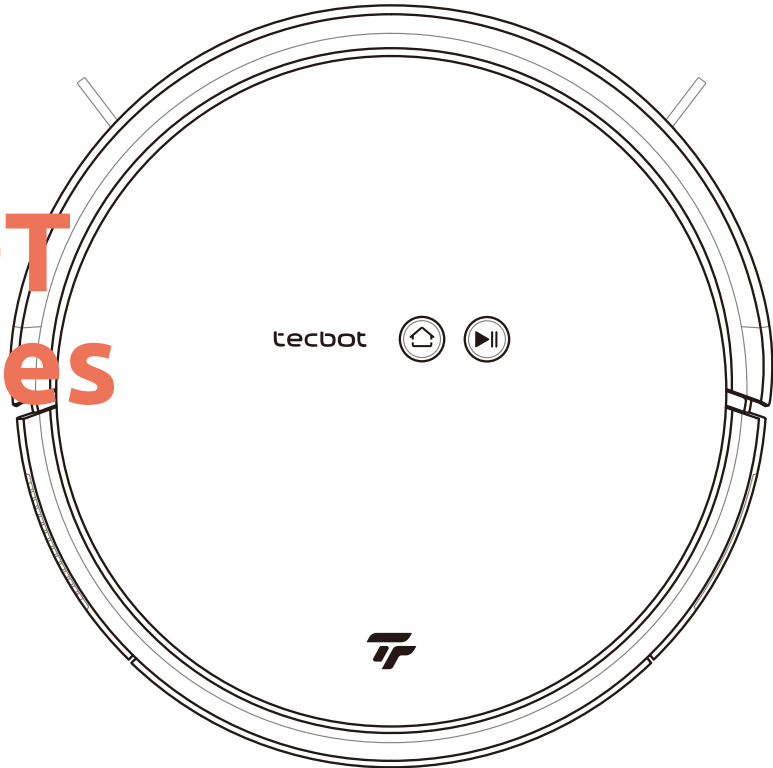

Before using your product, read through this User Manual carefully and keep it for future reference.

Welcome

Thank you for purchasing our TECBOT S1 Series, a robot vacuum cleaner.

TECBOT S1 Series has a gyroscope navigation system for accurate mapping, routing, and cleaning coverage. In addition, the upward-oriented vacuum exhaust avoids blowing pet hair around, making them ideal for homes with pets.

We are Tecbot, "Expert Manufactures of Cleaning Robots." We make cleaning easier to create more free time for you.

Table of content

Package list	3	Cleaning modes and mopping function	15
TECBOT S1 Series anatomy	4	Regular maintenance	18
Precautions	8	Troubleshooting and FAQs	22
Installation	9	Warnings and Restrictions	24
Pairing	10	Specifications	25
Charging	14	Hazardous materials	26

Package list

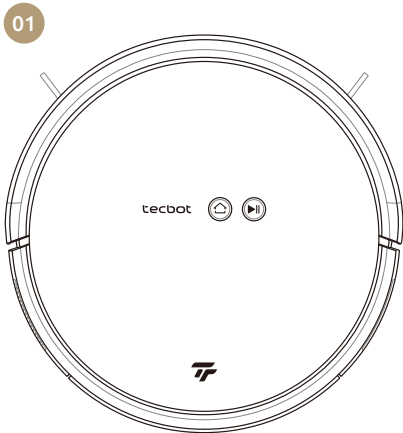

01 TECBOT S1 Series (Dust box included)

02 Charging dock

03 Power cord

04 Water tank (optional)

05 1 extra microfiber flat mop (optional)

06 2 extra edge-cleaning brushes

07 Remote control

08 2 AAA remote control batteries

09 Brush and hook knife cleaning tool

10 1 extra HEPA filter

11 User Manual

12 Warranty Card

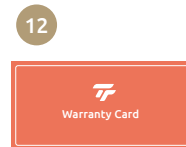
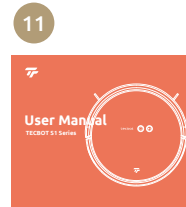
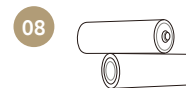
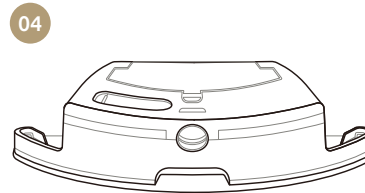
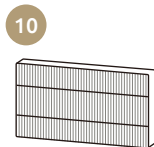
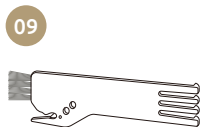
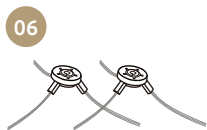
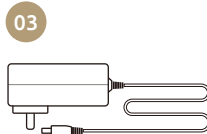
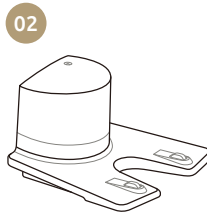

TECBOT S1 Series anatomy

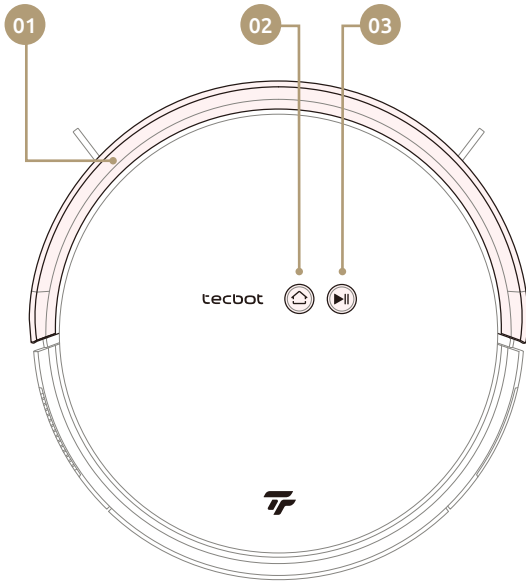

- 01 Collision bumper
- 02 Charging button
- 03 Start/Pause button

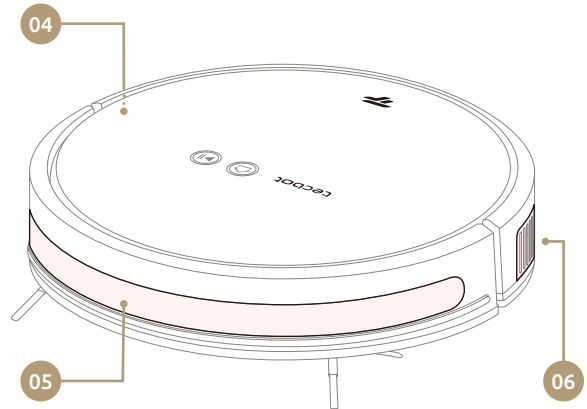

- 04 ON/OFF switch
- 05 ToF wall sensor
- 06 Vacuum exhaust

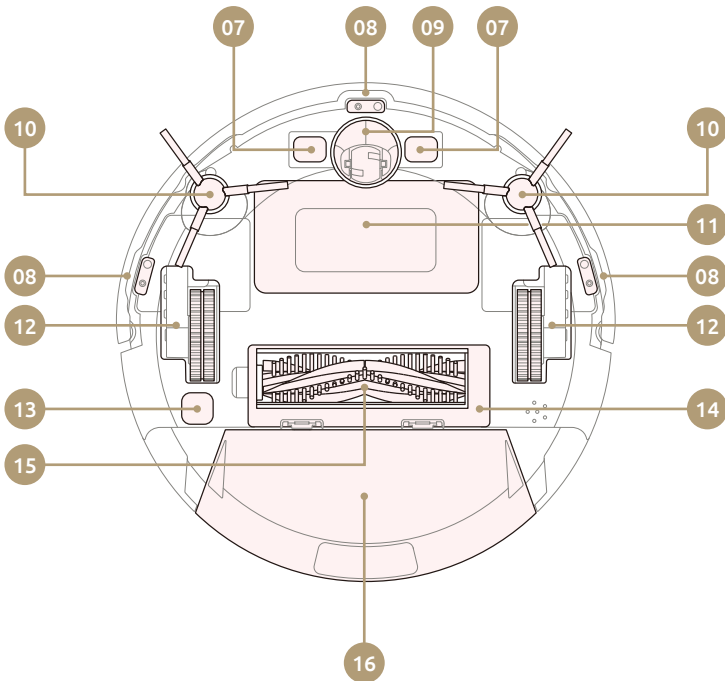

- 07 Contact point for charging dock
- 08 ToF cliff sensor
- 09 Driving wheel
- 10 Edge-cleaning brush
- 11 Battery cover
- 12 Wheel
- 13 ToF optical flow sensor
- 14 V-shaped brush main cover
- 15 V-shaped brush
- 16 Dust box or water tank

Dust box

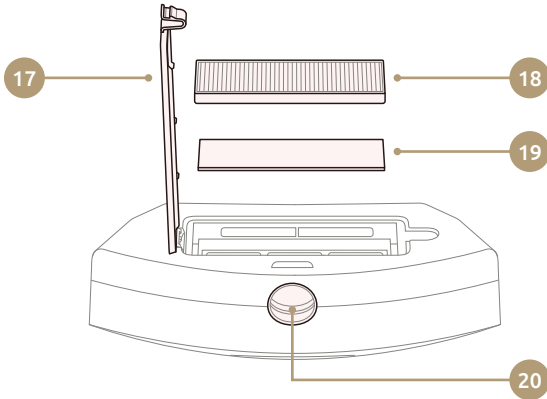

Dust box

- 17 Cover
- 18 HEPA filter
- 19 Sponge
- 20 Release clip

Water tank

- 21 Inlet
- 22 Microfiber mop
- 23 Release clip

Charging dock

- 24 Charging indicator light
- 25 Signal emitter
- 26 Charging contact points
- 27 Power adapter

Water tank

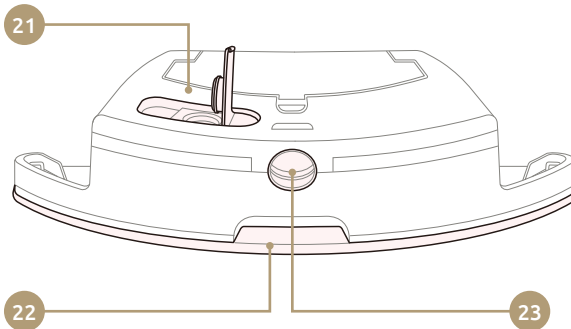

Charging dock

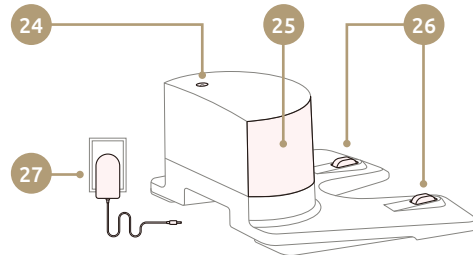

Remote control

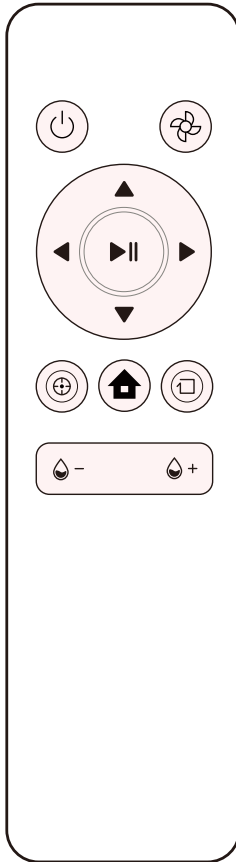



 **ON/OFF**

 **Vacuum suction power**
Adjust vacuum suction power.
Increase for a more heavy-duty vacuum cleaning or decrease for a longer and quieter cleaning run.

 **Start/Pause**

 **Forward**
Press and hold to move forward. Your TECBOT S1 Series will stop when encountering an obstacle.

 **Backward**
Press and hold to move backward. Release to stop.

 **Left and Right**
Press and hold to turn. Release to stop.

 **Charging**
Press to return your TECBOT S1 Series to the charging dock.

 **Spot cleaning mode**
Press to intensely clean an area. Your TECBOT S1 Series will spiral outward about 3 feet / 1 meter in diameter and then inward to where it started.

 **Edge cleaning mode**
Press to clean along the room's edges, including around chair legs and other furniture.

 **Mopping water levels**
Press to adjust the mopping water levels to avoid water stains damage and increase the running time.

Precautions

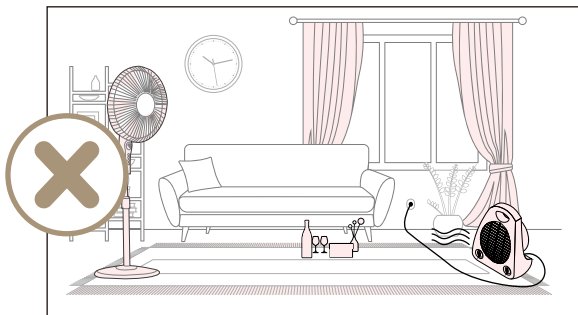

Before operating your TECBOT S1 Series, please remove any tripping hazard, litter, quickly falling objects and valuables, and potentially dangerous items from the floor. In addition, fold any fringe tassels edge under the carpet and lift the ends of curtains and tablecloths from the floor.

Please prevent your TECBOT S1 Series from getting stuck, entangled, dragging, or knocking down objects to avoid personal or property damage. Avoid blocking the movement of your TECBOT S1 Series by standing in its way. Place fences or set restricted area at the entrance of duplex staircases, open terraces, or any open area.

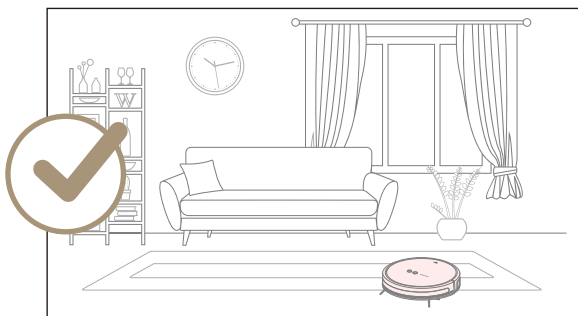

Prevent your TECBOT S1 Series from getting too close with open flames or high-temperature equipment during operation to extend its lifetime and avoid fires.



Do not pick up your TECBOT S1 Series with one hand to avoid accidentally releasing the dust box or water tank.

Retrieve the dust box or water tank when turning over your TECBOT S1 Series for maintenance.

Installation

- 01** After taking your TECBOT S1 Series out of the box, remove the protective foam on both sides.
- 02** Check whether all components are in place: dust box, V-shaped main brush, and edge-cleaning brushes.
- 03** Place the charging dock against a wall on a flat floor, and connect it to the power source. Please make sure there are more than 1.5 feet / 0.5 meter of free space at the front and 3 feet / 1 meter to the sides of the charging dock.
- 04** Turn on your TECBOT S1 Series.
- 05** Place your TECBOT S1 Series at the charging dock. Ensure the contact points on the TECBOT S1 Series and the charging dock are in complete contact. Your TECBOT S1 Series will make a “beep” to start charging. The charging time is about 4 hours.
- 06** Your TECBOT S1 Series is ready for Wi-Fi pairing.

NOTE:

Only use clean water or foamless floor cleaner in the water tank. Foam or bubbles will decrease the performance of the mopping function.

NOTE:

The ON/OFF switch is on the right side of your TECBOT S1 Series. (“I” position for ON and “O” for OFF, see page 4.) Your TECBOT S1 Series will self-check for about 10 seconds before turning on.

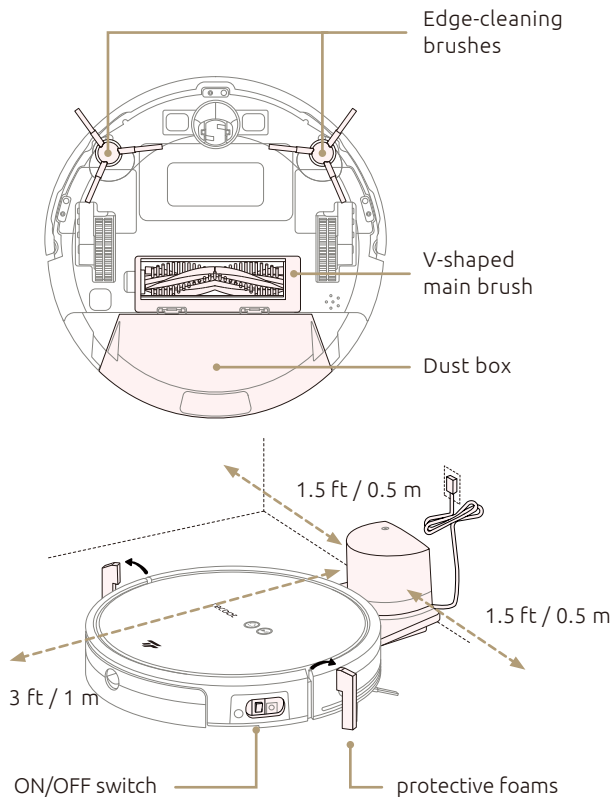

Pairing



Download Tecbot Home App

Download our Tecbot Home App by scanning the QR code or searching on the App Store or Google Play to enjoy all the functions of your TECBOT S1 Series wherever you are.



Automatic pairing (Bluetooth)

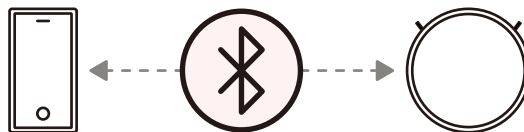

Automatic pairing via Bluetooth

Your Tecbot S1 Series will automatically try to pair with your mobile device via Bluetooth. Please ensure your Bluetooth connection is turned ON on your mobile device. In addition, please confirm:

- Your Wi-Fi router supports a 2.4 GHz frequency band.
- Your mobile device or tablet is connected to the Wi-Fi network of 2.4 GHz frequency band.
- Your mobile device or tablet operating system is up to date.

Automatic pairing (Bluetooth)

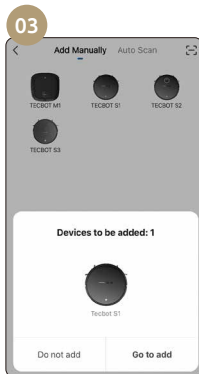
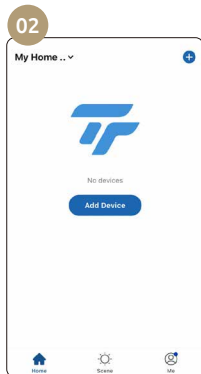
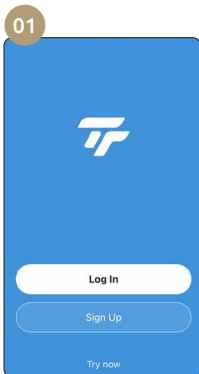

- 01 Sign up to register an account and log in.
- 02 Ensure your Tecbot S1 Series is turned ON (The ON/OFF switch is located at the side of your TECBOT S1 Series) and tap "Add Device."
- 03 Wait for the splash screens on your mobile device. Tap "Go to add."

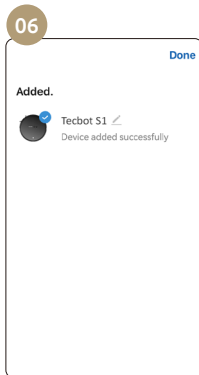
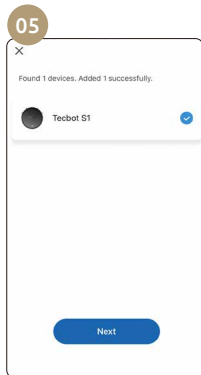
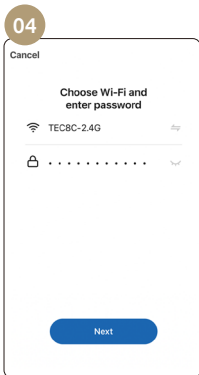

- 04 Enter your Wi-Fi password.
- 05 Keep your device as close as possible to your TECBOT S1 Series. Your TECBOT S1 Series Start/Pause button light will stop blinking to confirm pairing. Tap "Next."
- 06 **Success!** Your TECBOT S1 Series is ready.

Manual pairing (Wi-Fi)

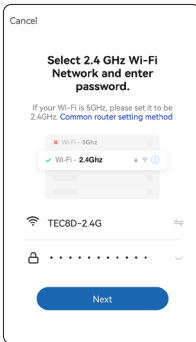

Before Wi-Fi pairing, please confirm:

- Your Wi-Fi router supports a 2.4 GHz frequency band.
- Your mobile device or tablet is connected to the Wi-Fi network of 2.4 GHz frequency band.
- Your mobile device or tablet operating system is up to date.



Manual pairing via Wi-Fi

If your Tecbot S1 Series is not pairing automatically, you can try to add it manually via Wi-Fi.

Using the manual mode, your TECBOT S1 Series will use your home Wi-Fi connection to pair with your device.

Manual pairing (Wi-Fi)

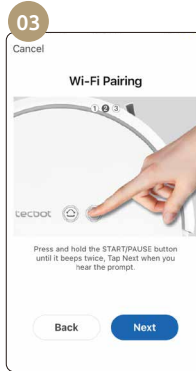
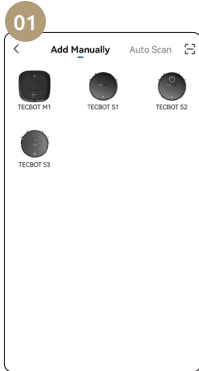

01 Tap "TECBOT S1" and enter your Wi-Fi password.

02 Restart your TECBOT S1 Series by switching it OFF and ON. The switch is located at the side of your TECBOT S1 Series.

03 Press and hold the Start/Pause button for 3 seconds **until it beeps once** to establish the Wi-Fi connection.

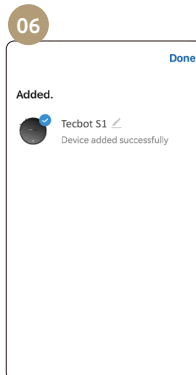
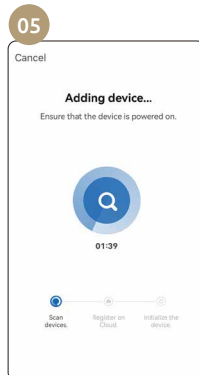

04 Confirm the Start/Pause button light is blinking and after you hear the voice prompt. Tap "Next."

05 Keep your device as close as possible to your TECBOT S1 Series. Your TECBOT S1 Series Start/Pause button light will stop blinking to confirm pairing.

06 **Success!** Your TECBOT S1 Series is ready.

Charging

Your TECBOT S1 Series will automatically return to the charging dock when its battery is lower than 20%. Press the charging button on your TECBOT S1 Series, remote control, or the Tecbot Home App to start the recharge function.

Your TECBOT S1 Series will not turn on when its battery is low. Please, manually place your TECBOT S1 Series on the charging dock. The indicator light on the charging dock will blink to indicate that charging has started.

Your TECBOT S1 Series takes about 6 hours to charge its battery fully.

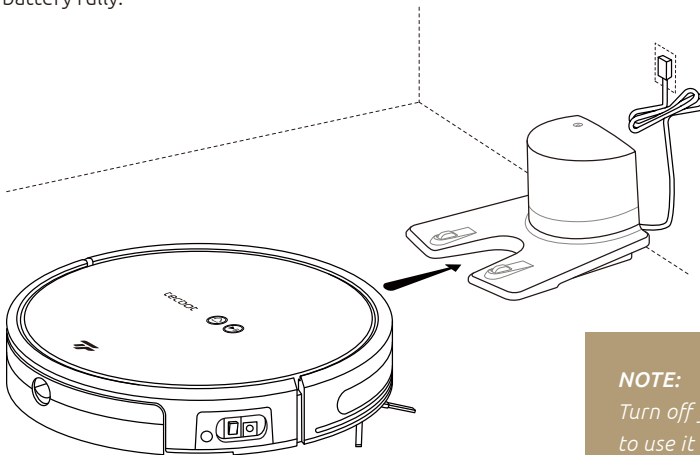

Battery

Your TECBOT S1 Series uses a high-performance lithium-ion rechargeable battery pack. Please charge your TECBOT S1 Series after daily use to maintain the battery performance.



Your TECBOT S1 Series will automatically return to the charging dock when its battery is lower than 20%.

NOTE:

Turn off your TECBOT S1 Series if you do not intend to use it in the following 24 hours.

Cleaning modes and mopping function

Cleaning modes

Automatic cleaning mode

Your TECBOT S1 Series will clean all the accessible areas of your house. TECBOT S1 Series will start to move straight along the wall/obstacles, and move in anti-clockwise direction for edge cleaning. Once the edge-cleaning is completed, it will automatically plan a zigzag path to clean the remaining space and avoid obstacles on its way.

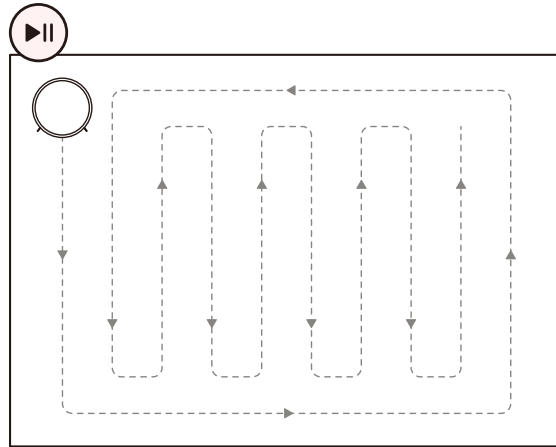

NOTES:

If your TECBOT S1 Series gets stuck, encounters obstacles, or needs to suspend the cleaning run for any reason, please pause your TECBOT S1 Series before moving it and putting it back within a radius of 3 feet / 1 meter from the "suspended position" to ensure the continuation and completion of the cleaning task.

When you only need to clean a single room, just close the door of this room. If there is no charging stand in this room, your TECBOT S1 Series will return to the point of origin after completing the task.

Cleaning modes

Edge cleaning mode

The edge cleaning mode will clean the corners of the room. Your TECBOT S1 Series will clean along fixed object edges (such as a wall) and returns to the charging base.

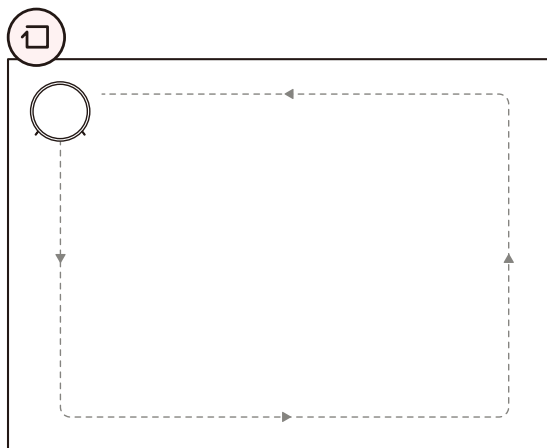

Spot cleaning mode

The spot cleaning mode is suitable for cleaning an area where the debris or dust is concentrated. Your TECBOT S1 Series will clean in a zigzag path and returns to the starting position.

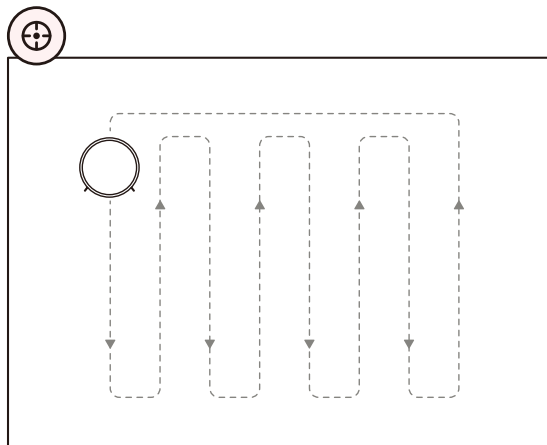

Mopping function

Place the microfiber mop in place, open the water inlet, slowly fill up the water tank with clean water, and close the water inlet tightly.

Place back the water-filled water tank.

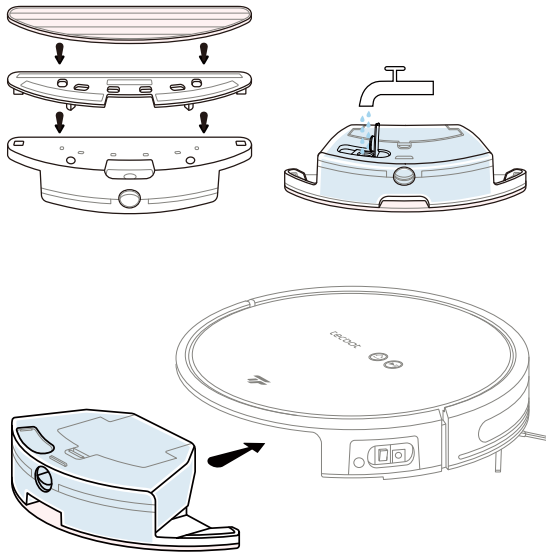

NOTES:

- *Ensure your TECBOT S1 Series is fully charged.*
- *Fold any fringe tassels edges under the carpet to prevent dirtying them during the mopping.*
- *Do not use the mop mode over a carpet.*
- *It is recommended to use purified or demineralized water to prolong the life of the water tank.*
- *If you need to add water to the water tank, please pause your TECBOT S1 Series before retrieving the water tank for filling, and do not move your TECBOT S1 Series away from its pause position.*
- *After the mop is done, please rinse and empty the water tank and remove and rinse the microfiber mop.*

Regular maintenance



Please turn off your TECBOT S1 Series and retrieve the dust box or water tank when turning it over for maintenance.

Edge-cleaning brushes

It is recommended to replace after 6 months.

- Turn over your TECBOT S1 Series and remove the edge-cleaning brushes by pulling them upwards.
- Clean the edge-cleaning brushes with a clean cloth.
- Reinstall the edge-cleaning brushes by snapping them into place until you hear a “click” sound.

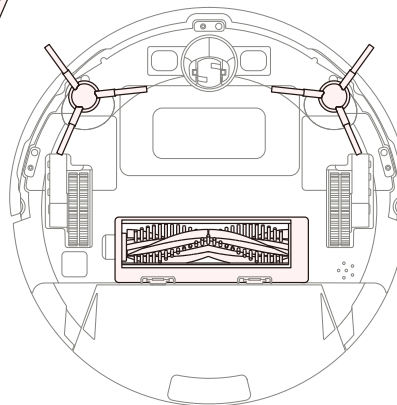
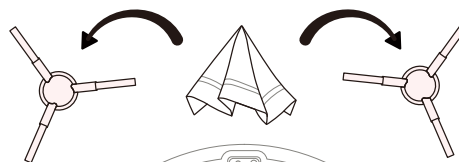

V-shaped main brush

It is recommended to clean up at least once a week.

- Turn over your TECBOT S1 Series, and remove the V-shaped main brush cover by pushing on both sides clips.
- Retrieve the V-shaped main brush upwards.
- Use the cleaning tool to remove any entanglement.
- Reinstall the V-shaped main brush and its cover.

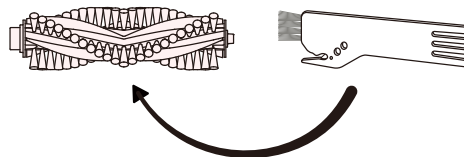

Contact point and sensors

It is recommended to clean up once a month.

- Always keep all sensors' windows clean.
- Wipe clean all sensors' windows and contact points with a soft dry cloth.

Driving wheel

It is recommended to clean up at least once a week.

- Remove entanglements and clean off any dirt on the driving wheel body and axle.

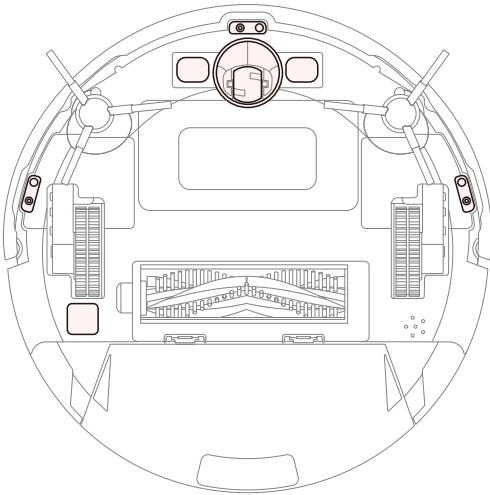

Dust box

It is recommended to clean up at least once a week.

- Retrieve the dust box from your TECBOT S1 Series pressing its release clip.
- Push the release clip to open the dust box.
- Empty it.
- Reinstall the dust box.

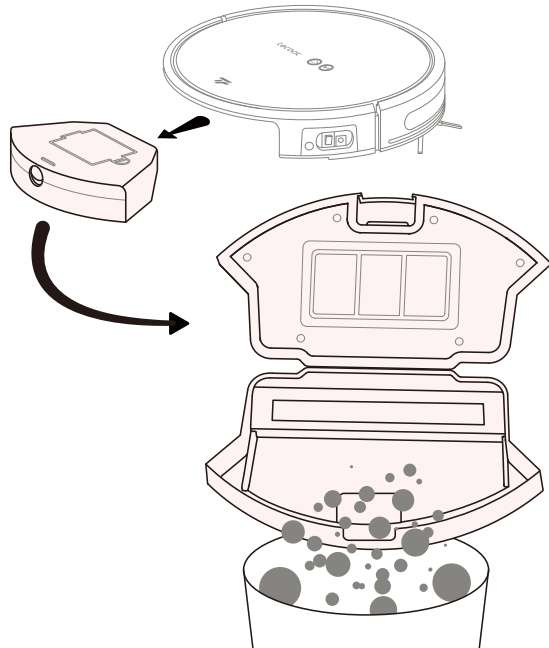

Water tank components

It is recommended to clean up once a month.

- Open the water tank top cover, and retrieve the HEPA filter and sponge.
- Rinse the water tank, sponge, and air filter with clean water. Do not use stiff brushes or fingers to clean the filters.
- Use a hand vacuum cleaner or cleaning brush to clean the HEPA filter. Do not clean with water.
- Shake out the water droplets from the water tank, sponge, and air filter.
- Let them dry in the air for at least 24 hours.
- Assemble back the water tank and place it into your TECBOT S1 Series.

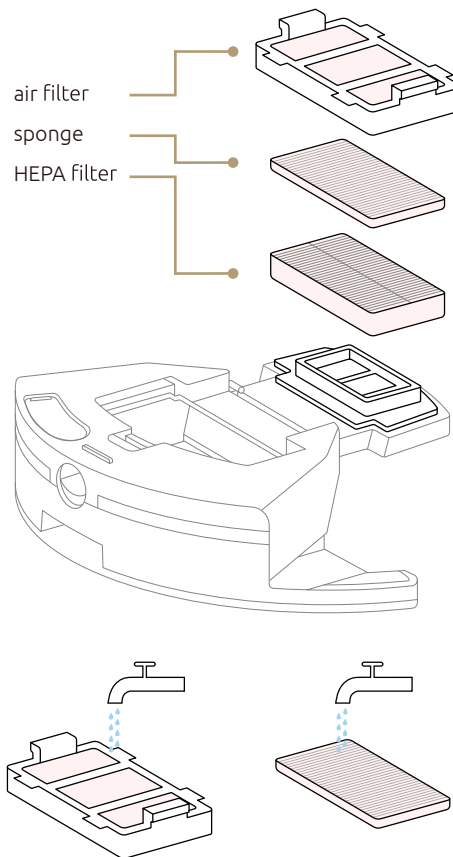

Dust box components

It is recommended to clean up once a month.

- Open the dust box top cover, and retrieve the HEPA filter and sponge.
- Rinse the dust box, sponge, and air filter with clean water. Do not use stiff brushes or fingers to clean the filters.
- Use a hand vacuum cleaner or cleaning brush to clean the HEPA filter. Do not clean with water.
- Shake out the water droplets from the dust box, sponge, and air filter.
- Let them dry in the air for at least 24 hours.
- Assemble back the dust box and place it into your TECBOT S1 Series.

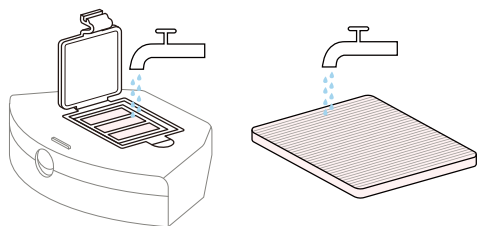
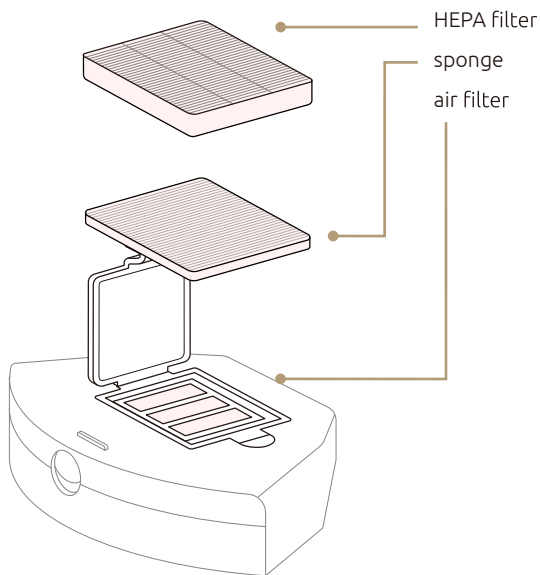

NOTES:

- It is recommended to replace the HEPA filter between 6 to 12 months to ensure an excellent vacuum effect.
- Use a brush to clean the dust accumulated in the HEPA filter regularly.
- The longest age of the HEPA filter is 12 months.

Troubleshooting and FAQs

It doesn't charge.

Ensure that both ends of the charging dock power cord are plugged in. Clean the charging station and TECBOT S1 Series contact points and confirm that the charging dock indicator is on.

It doesn't return to the charging dock station.

Put the charging dock in an open area. Place your TECBOT S1 Series near the charging dock and try again. Confirm whether the charging dock is powered and its contact points and signal emitter are clean.

Cleaning ability decreased, or dust is dropping.

The dust box has filled up, the filters are blocked, and the V-shaped main brush and edge-cleaning brushes are entangled. Please turn off your TECBOT S1 Series before maintenance.

Mopping ability decreased.

Clean any dirt on the outlets at the bottom of the water tank. Check whether the water tank is filled. Fill up the water tank before starting the cleaning task.

It doesn't return to recharge after partial cleaning or moving away.

Your TECBOT S1 Series will redraw the map after a partial cleaning or long-distance movement. It may not be able to return to recharge if the charging base is too far away. Manually put your TECBOT S1 Series into the charging dock.

The scheduled cleaning does not happen.

Ensure your TECBOT S1 Series is turned on. When the battery is low, the scheduled cleaning will start after the battery level is above 20%.

The operating speed and cleaning times differ between surfaces, such as wooden and ceramic tiles.

Operating speed and cleaning times vary according to the complexity of the room, the amount of debris, the cleaning mode, and surfaces' unique characteristics.

Abnormal noise during cleaning.

Turn OFF your TECBOT S1 Series for cleaning. Clean any entanglement on the V-shaped main brush, edge-cleaning brushes, or wheels.

Abnormal behavior.

Restart your TECBOT S1 Series by turning it off and on.

It doesn't avoid obstacles.

Check and clean the front and side sensors' windows.

It fell down the stairs during cleaning.

Check and wipe clean all the cliff sensors' windows.

The remote control fails.

The effective remote control range is 4 feet / 1.2 meter. Check your TECBOT S1 Series in turned ON and charge. Replace the remote control batteries with new ones. Clean the remote control and your TECBOT S1 Series infrared transmitter, and check that there is no other infrared transmitter device interfering with the signal, such as a TV.

It does not clean specific areas.

Cables, slippers, and other objects placed on the floor affect the regular operation and scan functions of your TECBOT S1 Series. Tidy up the wires, slippers, and other things scattered on the floor. It is also recommended not to interfere with the cleaning path by moving your TECBOT S1 Series or blocking it.

Tecbot Home App can not be paired.

- Check your home Wi-Fi router supports the 2.4 GHz frequency band.
- Check your home Wi-Fi password input is correct.
- Check your Wi-Fi router does not have a firewall.
- Check if your TECBOT S1 Series Start/Pause button light is blinking.

Add family members to the Tecbot Home App.

Tap "Me" to select family management.

Tecbot Home App does not have a map.

Tap "Smart plan cleaning." Tap "more" to save the map in the map management after the TECBOT S1 Series icon appears.

"Selection cleaning" can not be selected.

You can edit the map after the map is saved.

Create smart cleaning.

Open the Tecbot Home App and tap "Smart." Tap the "+" to add.

Warnings and Restrictions

- Use your TECBOT S1 Series according to this User Manual. The user will bear any loss and injury caused by improper use.
- Ensure the dust box and filters are properly installed before using your TECBOT S1 Series.
- Ensure the power supply voltage matches the voltage marked on the charging dock.
- Do not place the charging dock near a heat source (such as a radiator).
- Do not use your TECBOT S1 Series in environments where the temperature exceeds 104 °F (40 °C) or is lower than 32 °F (0 °C).
- Do not use any mop mode on the carpet.
- Incorrect use of floor cleaner liquid may cause damage to your TECBOT S1 Series. For a better cleaning experience, it is recommended to use Tecbot floor cleaner.
- Do not use your TECBOT S1 Series for cleaning long-haired carpets (it may not work correctly on some dark-colored carpets.)
- Do not use your TECBOT S1 Series over damp, standing water, or sticky surfaces.
- Only use your TECBOT S1 Series in-home or office environments. Please do not use it in commercial or industrial environments.
- When operating, do not place hair, fingers, or pets close to the vacuum.
- Do not allow people with physical, mental, or sensory impairments and children to operate your TECBOT S1 Series.
- Do not place any objects on your TECBOT S1 Series, including children and pets.
- Do not allow children to use your TECBOT S1 Series as a toy. Supervise children and pets when it is operating.
- Do not allow your TECBOT S1 Series to vacuum over hard or sharp objects (such as decoration litter, glass, iron nails, etc.)
- Do not use your TECBOT S1 Series to clean any burning objects or flammable substances (such as unextinguished cigarettes, gasoline, and printer toner.)
- Stop using the power cord and charging dock if broken or damaged.
- Do not disassemble, repair, or modify the battery and charging dock.
- Keep your TECBOT S1 Series cleaning tools out of reach of children.
- Do not clean or maintain when it's turned on. Unplug the charging dock before cleaning or maintenance.
- Do not use a damp cloth or any liquid to clean any part of your TECBOT S1 Series.
- Do not use any third-party batteries or charging docks.

- Carry your TECBOT S1 Series with both hands, and do not use the collision bumper as a handle.
- Transport your TECBOT S1 Series using the original packing box and ensure it is turned off.
- If you intend not to use your TECBOT S1 Series for a long time, charge it fully and turn it off. Please keep it in a cool and dry place. Charge it at least once every 3 months to avoid excessive battery discharge.
- Consult a professional recycling agency for directions to discard used batteries.
- Incineration of your TECBOT S1 Series is prohibited even if the product is severely damaged. In addition, the battery may explode.

Specifications

Dimensions:

13.8 x 2.95 inch

Product weight:

6.6 lb

Vacuum power:

1800 Pa for S1 or
3000 Pa for S1 Pro

Noise level:

<68 dB

Battery type:

Rechargeable Li-ion
battery pack

Battery:

14.4 V
2600mAh for S1 or
5200mAh for S1 Pro

Rated power:

25 W

Dust box capacity:

600ml

Water tank capacity:

320 ml (optional)

**Obstacle clearance
maximum height:**

0.75 inch

Operating time:

~100 min

Charging dock model:

TEC400

Remote control model:

TEC1089

Hazardous materials

Parts	Pb	Hg	Cd	Cr(VI)	PBB	PBDE	Elements
Plastic parts	O	O	O	O	O	O	Pb Lead
Hardware	X	O	O	O	O	O	Hg Mercury
Circuit board	X	O	O	O	O	O	Cd Chromium
Electronic	O	O	X	O	O	O	Cr(VI) Hexavalent Chromium
Battery	O	O	O	O	O	O	
Plug power cord (metal part)	X	O	O	O	O	O	PBB Polybrominated biphenyls PBDE Polybrominated phenyl ether

Notes

- X** The amount in at least a certain part exceeds the limit requirement of the GB/T 26572 regulation, and there is currently no proven alternative in the industry that meets the environmental protection requirements of the EU RoHS regulations.
- O** The amount in the parts is below the limit requirement of the GB/T 26572 regulation.

Implementation standards:



GB4706.1-2005
GB4706.7-2014

GB4343.1-2009
GB17625.1-2012



The environmental protection use period of the product under normal use is 5 years.

TECBOT S1 Series

Manufacturer:

Shenzhen Tecbot Intelligent Robot Co., Ltd.

Address:

8D, Nanyuan Maple Leaf Building,
Nanshan Avenue No.1088, Shenzhen, Guangdong, China.

Manufacturer:

Guangdong Jingrong Technology Holdings Co., Ltd.

Address:

Jingrong Industrial Park, Shunfeng Road,
Dongguan, Guangdong, China.

Customer Service Department email:

hi@tecbot.ai

Website:

www.tecbot.ai