

# Pericat

# Multimedia Projector

# USER MANUAL

Model:Q9

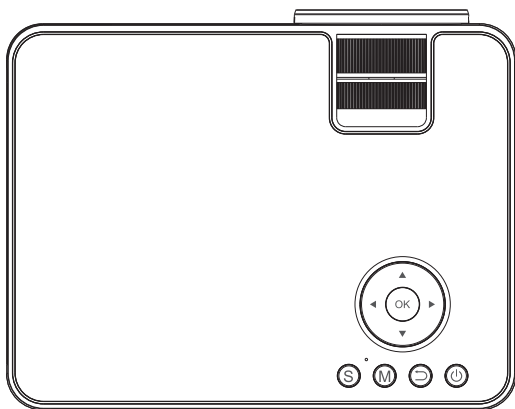

Before using your new product, please read these instructions to prevent any damage.

---

(English)

## **CONTENTS**

Notice .....	02
Accessory List .....	03
Safety Notice .....	04
Remote Control .....	05
User Manual .....	06
Optical Adjustments .....	11
Connections .....	12
Menu Settings .....	18
Connect to Bluetooth Speaker .....	19
Screen Mirroring .....	20
Projector Installation .....	26
Technology Features .....	27

## NOTICE

1. Not recommended for Powerpoint , Word, Excel, or business presentations.
2. To connect the mini projector with a tablet or smartphone, please use Wi-Fi screen mirroring feature or use external HDMI adaptor. For HDMI adaptor connection, Android phones need to support MHL and an MHL to HDMI cable is required, iPhone & iPad need a Lightning to HDMI cable adaptor.
3. To connect the mini projector to PC or laptop, please adjust the PC/laptop display resolution to 1920\*1080 for best clarity.
4. Please note that it is only suitable for use in dark rooms.
5. Dolby is not supported. Please turn off Dolby digital on your device.

## FCC Warning

This device complies with part 15 of the FCC rules. Operation is subject to the following two conditions:

(1) This device may not cause harmful interference, and

(2) This device must accept any interference received including interference that may cause undesired operation.)

The manufacturer is not responsible for any radio or tv interference caused by unauthorized modifications or change to this equipment. Such modifications or change could void the user's authority to operate the equipment.

This equipment has been tested and found to comply with the limits for a Class B digital device, pursuant to part 15 of the FCC Rules.

These limits are designed to provide reasonable protection against harmful interference in a residential installation.

This equipment generates uses and can radiate radio frequency energy and, if not installed and used in accordance with the instructions,

may cause harmful interference to radio communications. However, there is no guarantee that interference will not occur in a particular installation.

If this equipment does cause harmful interference to radio or television reception, which can be determined by turning the equipment off and on, the user is encouraged to try to correct the interference by one or more of the following measures:

- Reorient or relocate the receiving antenna.
- Increase the separation between the equipment and receiver.
- Connect the equipment into an outlet on a circuit different from that to which the receiver is connected.
- Consult the dealer or an experienced radio/TV technician for help.ved including interference that may cause undesired operation.)

RF warning statement:

The device has been evaluated to meet general RF exposure requirement.

The device can be used in portable exposure condition without restriction.

## ACCESSORY LIST

- 1 x AV Signal Cable
- 1 x Remote Control (battery not included)
- 1 x HDMI Cable
- 1 x Power Cable
- 1 x Carry Bag
- 1 x Screen
- 1 x Tripod
- 1 x User Manual

## SAFETY NOTICE

1. Please read the user manual carefully before using the projector.
2. Please use standard power cord with ground wire, to ensure stable power supply.
3. Please use the same power voltage as marked on the projector.
4. Please do not disassemble the projector by yourself, otherwise the warranty will be void.
5. Please do not look into the lens when the projector is working, otherwise it may hurt your eyes.
6. Please do not cover the projector ventilation holes with any material.
7. Please keep the projector away from water or any other liquid as it is not waterproof.
8. Please don't put the projector in wet or moist conditions to prevent electric shock.
9. Please turn off and unplug from the power supply if not using the projector for a long time.
10. Please use the original packing foam or other anti-shock material when relocating the projector.
11. Please contact our customer support if you encounter any problem with the projector.
12. This mini projector comes with a full 12-month warranty.
13. Please contact us if you want to know more information about the warranty. (Warranty service does not include the frame, manual, packing and subjective ideas about the video, sound or image aspects)

## REMOTE CONTROL

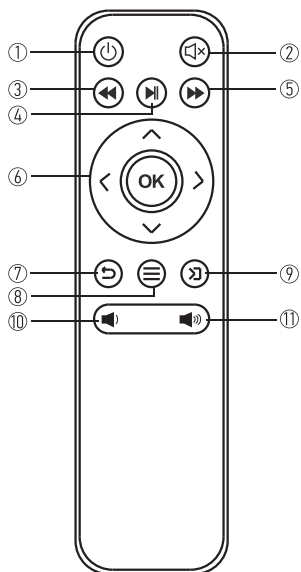

1. Power On/Off

2. Mute

3. Rewind

4. Play / Pause

5. Fast forward

6. Arrow Keys

7. Back

8. Menu

9. Signal source

10. Volume -

11. Volume +

### Caution

Do not submerge the remote control in water.

Do not put the remote control near a fire or in a wet/hot place.

Do not use old and new batteries together in the remote control.

Please take the batteries out if not using the remote control for a long time to avoid battery leakage.

Please point the remote control at the IR receiver.

Please use the remote control within 6 meters distance and 30 degree angle.

# USER MANUAL

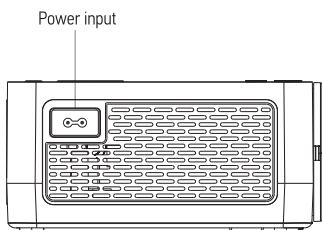
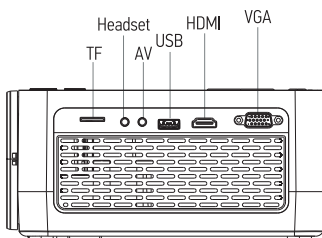
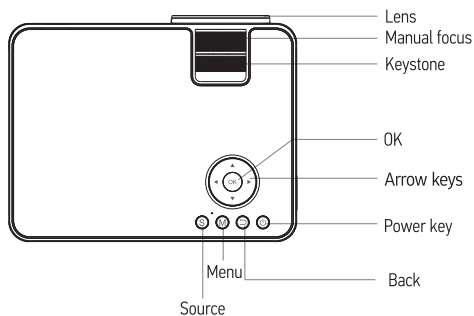

## 1. Connecting the projector to power

a. Connect the power cable to the projector.

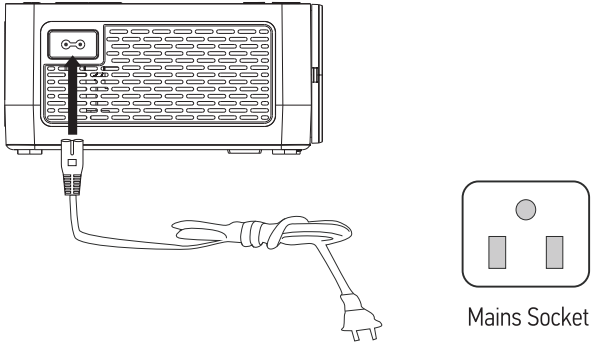

b. The projector will display an indicator light when connected to power.

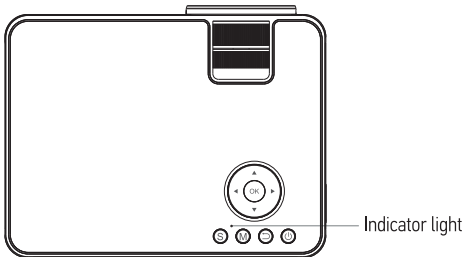



## 2. Power ON/OFF

Press the "⏻" button on the projector or on the remote control to power on. After the projector gets power through the power cable, it goes into stand-by status.

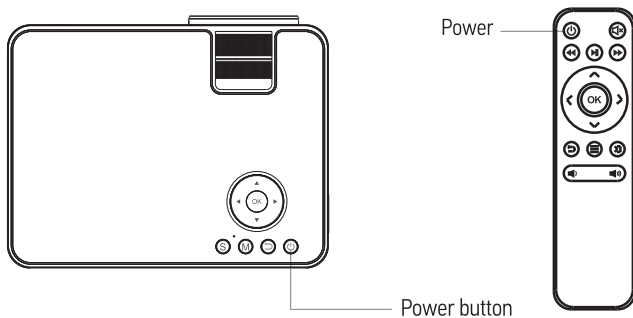

### 3.Multimedia boot screen

After 5-10 seconds, the multimedia screen will be displayed.

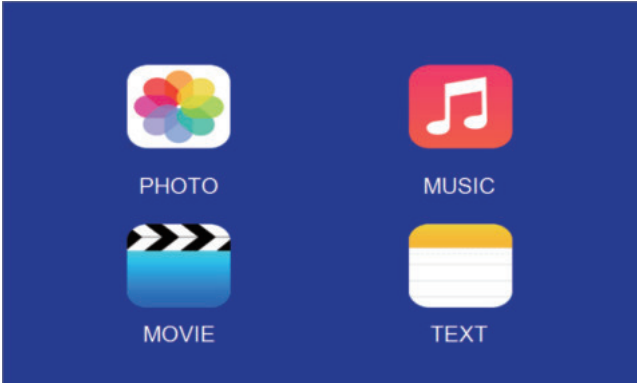

### 4. Focus & Keystone correction

- a. If the image is displayed as a trapezoid shape, you can adjust it with the keystone correction function by turning the keystone ring. This should normalize the display image.

b. Image focusing

Make sure the projector is horizontal to the projector screen and adjust the focus by turning the focus ring.

You can display video or the menu screen to check the adjustment.

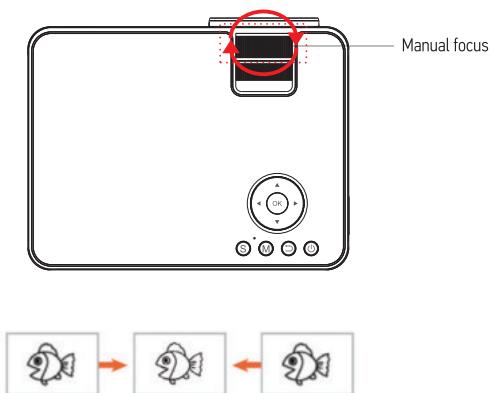

## OPTICAL ADJUSTMENTS

The projector uses an optical keystone correction function, so the image can be adjusted as below:

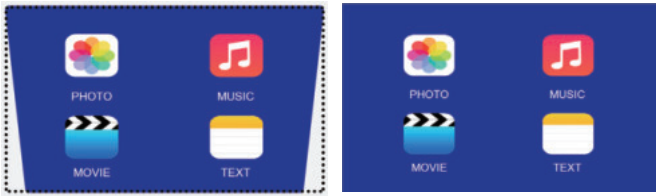

However, this projector does not have a horizontal keystone correction function. The projector must be placed horizontally to the projection screen. If you encounter the problem as shown above, it is probably because the projector has not been placed horizontally to the projection screen, or the projection screen is not vertically positioned.

Solution: Adjust the projector's position so that it is horizontal to the screen.

## CONNECTIONS

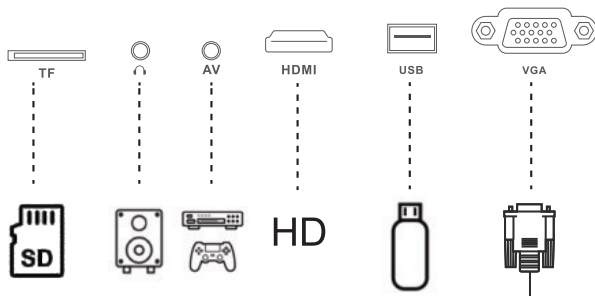

Connect multiple devices and applications.

## 1. Playing media from a USB

- a. Insert the USB flash into the USB slot.

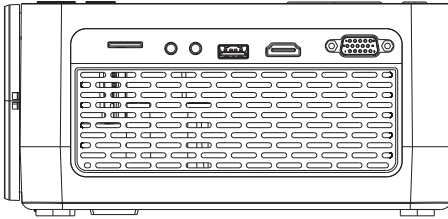

- b. Choose USB (marked OUT5V) as source from the menu.

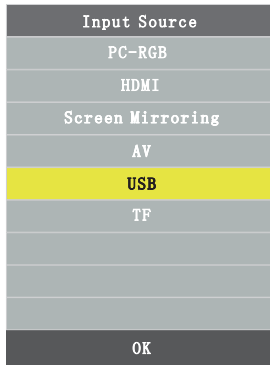

Supported multimedia formats

Multimedia	Audio file	MP3/WMA/OGG/AAC/MA4/FLAC/APE/WAV
	Picture file	JPEG/BMP/PNG
	Video file	MPEG1, MPEG2, FLV, MPEG4, RM, AVI /RMVB, MOV, MKV, DIVX, FVOB M-JPEG (only unspported 640*480)
	Text file	TXT

c. Choose the content which you need to display:

PHOTO / MUSIC / MOVIE / TEXT.

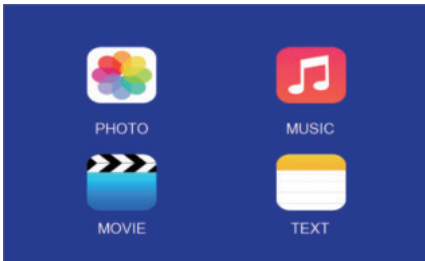

d. Choose the file you want to display. Press “▶|” to display or stop.

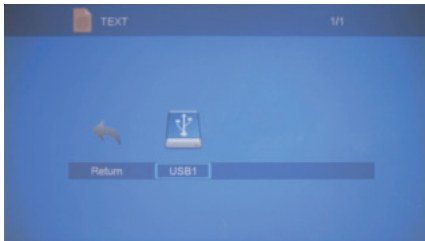

## 2. AV video connection

Use a 3-in-1 AV cable to connect to the projector as shown below. Once connected, select the AV signal source.

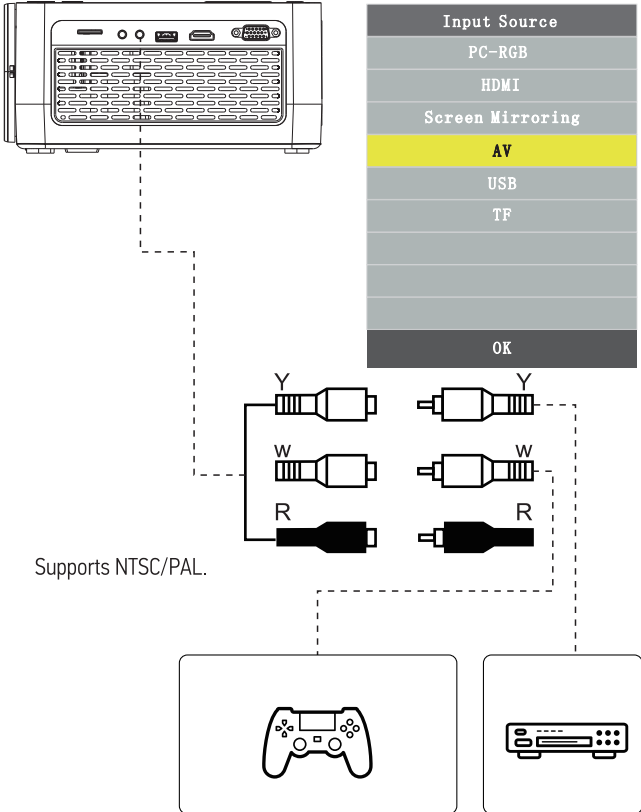



### 3. HDMI connection

Use the HDMI slot to connect computers and HDMI compatible devices. Once connected, select the HDMI signal source.

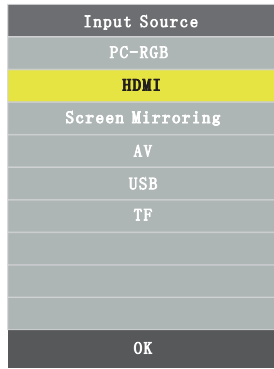
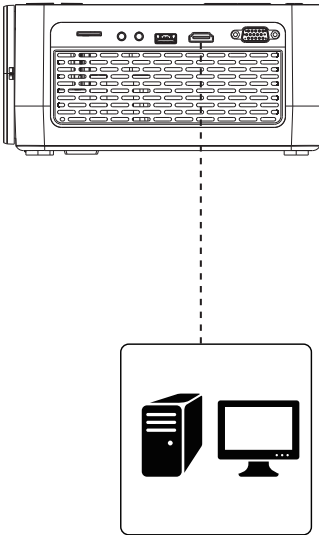

Supported resolutions:

576P, 480P, 720P, 1080P, 640x480, 800x600, 1024x768, 1280x1024, 1280x720, 1440x900, 1366x768, 1920x1080, 1280x800, 1440x960, 680x1050

#### 4. 3.5mm audio connection

Use the 3.5mm audio jack to connect headphones and speaker equipment.

Note: This projector does not support Dolby sound.

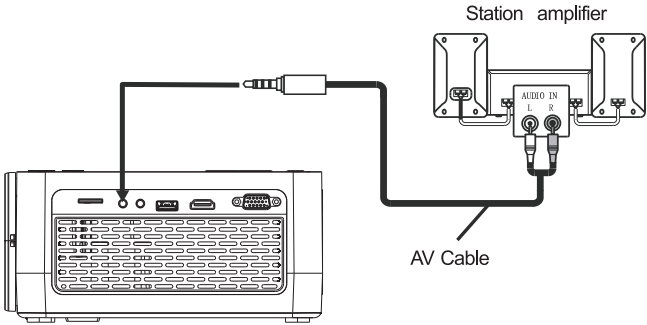

## MENU SETTINGS

### 1. Remote control user guide

Press the “☰” key to enter the main menu, then press “◀▶” to enter each sub-menu.

Press “▼▲” to select the sub-menu, then adjust the parameters as required, and press the “OK” key to confirm.

### 2. Function of sub-menus

#### a. Picture sub-menus:

Available adjustment: Picture Mode / Color Temperature / Aspect Ratio / Noise Reduction / Reduce Display size

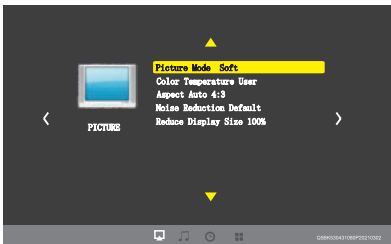

#### b. Sound sub-menus:

Available adjustment: Sound Mode / Balance / Auto Volume / Surround Sound / Bluetooth

#### c. Option sub-menus:

Available adjustment: OSD Language / Restore Factory / Rotate / OSD Duration / Software Update(USB)

#### d. Time sub-menus:

Sleep Timer

## CONNECT TO BLUETOOTH SPEAKER

1. Enter menu Sound -> Bluetooth

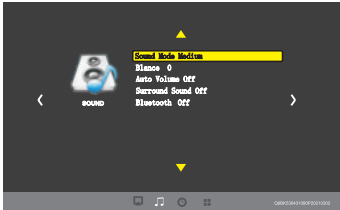

2. Press “◀▶” key to turn Bluetooth on

3. Select Search and press OK key to scan nearby Bluetooth speakers

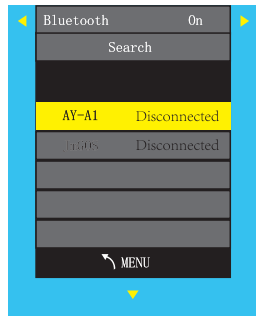
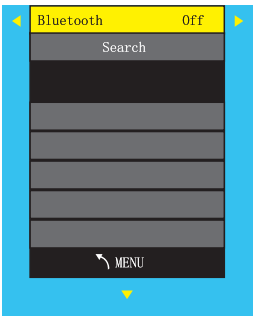

4. Select your Bluetooth speaker from the list, press OK key to connect (pair).

### 💡 Tips:

When power on the projector or turn on Bluetooth, the projector attempts to connect the latest connected Bluetooth speaker.

## SCREEN MIRRORING

1. Select Screen Mirroring in the Input Source list
2. Press the OK key to enter the interface
3. After entering into the interface, select the function you need (Figure 1)

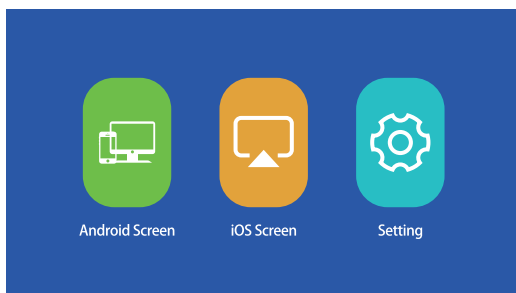
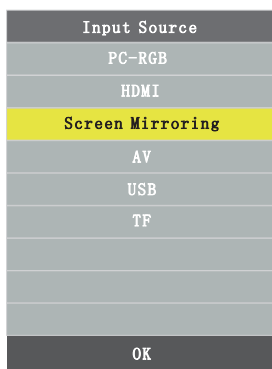

Figure 1

## a. Connect Projector to Wi-Fi Router

There are two methods to connect the projector to the Wi-Fi router.

Method 1: Connect to Wi-Fi router through system menu

1. Select Setting function

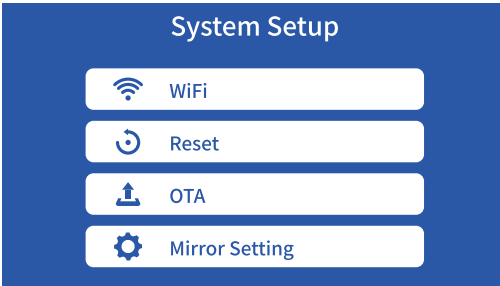

2.1 Select WiFi from System Setup menu, then the projector will scan for nearby Wi-Fi.

2.2 Support 2.4 & 5GHz dual-frequency signal use, the connection method is the same

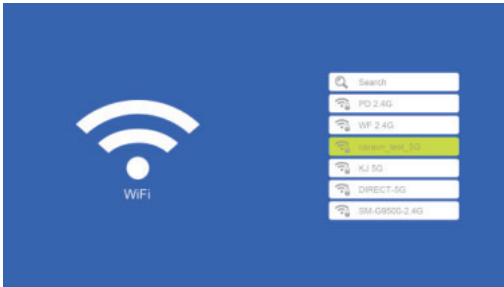

3. Select the Wi-Fi you want from the search result list and enter password to connect.

## a. Android Screen

Android Screen has two connection methods.

Method 1: Wireless connection (Recommended)

1. Select Android Screen function

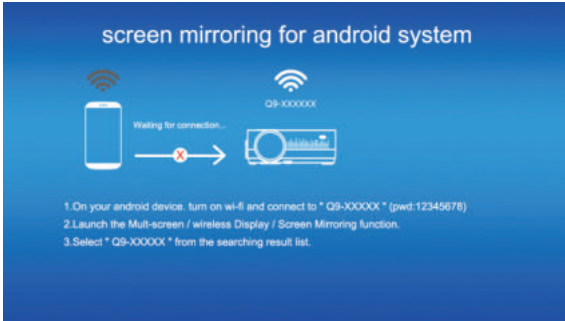

2. Turn on the WLAN on the Android device

3. Launch the Multi-screen/ Wireless Display / Screen Mirroring / Smart View function / Cast (Figuer1)

3. Select "Q9-XXXXXX" from the searching result list (Figure 2)

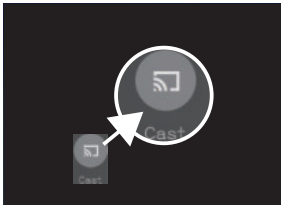

Figuer 1

Cast	⋮
Q9-XXXXXX Wireless display	⚙️

Figuer 2

⚠️ Some Android devices may not support screen mirroring due to the compatibility.

---

---

## Method 2: Wired connection

1. Select Android Screen function
2. On your Android device, find Developer options and turn on USB debugging
3. Connect your Android device to the projector OUT5V port with ORIGINAL USB cable
4. For the first time, your Android device will pop below the “Allow USB Debugging” window, select “Always allow from this computer” and tap “OK” to start screen mirroring.

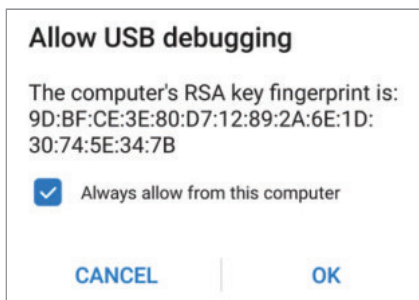

### Tip:

The steps to turn on USB debugging vary from different models of Android devices.

You may check it from internet. We take Samsung Galaxy S8+ as example:

1. Go to setting, then tap About->Software Information->Build number
2. Repeatedly tap Build number for several times until it shows Developer mode is turned on
3. Go back to settings, you will find Develop option. Tap it into Develop option
4. Find USB debugging option and enable it



1. Some Android devices may not support screen mirroring due to the compatibility.
2. Some Android devices may only transfer the display without audio due to the protocol restrictions.



## b. iOS Screen

iOS Screen has three connection methods.

Method 1: Wireless connection with Wi-Fi router (Recommended)

1. Connect the projector to a Wi-Fi router (refer to c. Setting)
2. Select iOS Screen function
3. Connect your iOS device to same Wi-Fi router
4. Turn on Screen Mirroring on your iOS device, select the device name of the projector.



Method 2: Wireless connection without Wi-Fi router

1. Projector doesn't need to connect to Wi-Fi router
2. Select iOS Screen function
3. Turn on Wi-Fi on your iOS device and search for the network name of the projector, for example: Q9-XXXXXX, select it and enter password 12345678, then your iOS device will connect to the projector.
4. Turn on Screen Mirroring on your iOS device, select the device name of the projector.



Method 3: Wired connection:

1. Select iOS Screen function
2. Connect your iOS device to the projector OUT5V port with a USB cable
3. For the first time, your iOS device will pop up a trust prompt

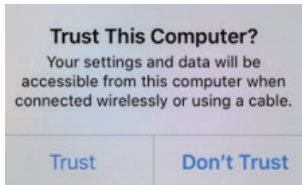

4. Confirm "Trust", then the screen mirroring will start

### c.Setting

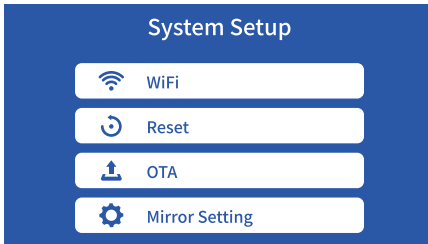

WiFi: Connect the projector to Wi-Fi router

Reset: Restore the Screen Mirroring function factory Settings

OTA: Online upgrade

Mirror Setting: Mirror mode/Airplay mode

---

---

## PROJECTOR INSTALLATION

Please refer to the following diagram for mounting the projector on a ceiling.

Do not place the projector near heat sources to prevent the projector from overheating.

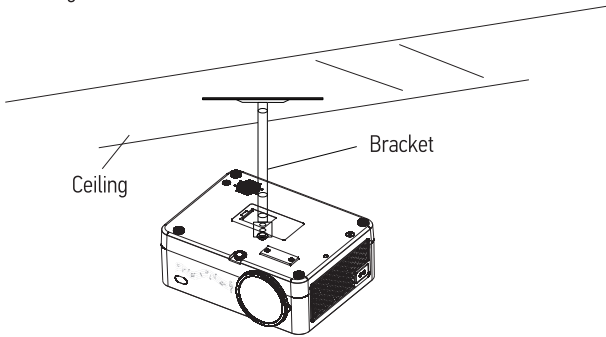

When ceiling mounting the projector, please ensure screws of a suitable quality are used, and that screw depth is deep enough to prevent the projector from falling.

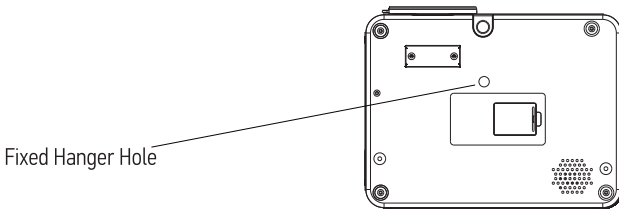

## TECHNOLOGY FEATURES

### 1. Basic parameters

Imaging Technology	LTPS LCD	Color Reproduction	16.7kk
Resolution	1920*1080	Keystone	Manual Correction $\pm 15^\circ$
Highest Resolution	1920*1080	Power Voltage	AC 100-240V 50/60Hz
Light	LED	Integrated watt	68W(Max)
Life Span	20,000 hrs	Input	USB/VGA/HDMI/AV/TF
Lens	Multichip Coated	Output	Earphone USB(5V-500MA)
Operation Mode	Lens (F=125) Manual Operation	Speaker	4Ω 3W
		System support	Support multi-media
		Language support	Support 23 Language
Throw Distance	1. 3-4.8M	Unit size	226. 5*171. 5*85mm
Screen Size	40-150Inches	Projector Ratio	1.45:1
Aspect Ratio	4:3/16:9	Net Weight	1. 38KG

### 2. Projection distance and screen size

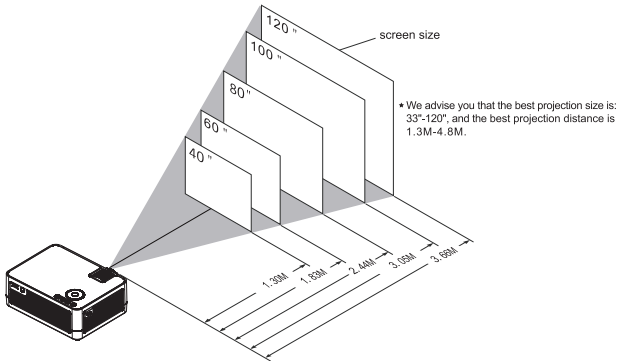

For reference only. The projection distance and screen size differ based on the configuration of the projector.

# Pericat

 [www.pericatstore.com](http://www.pericatstore.com)

 [support@pericatstore.com](mailto:support@pericatstore.com)

 1-833-300-9545



Made in China