

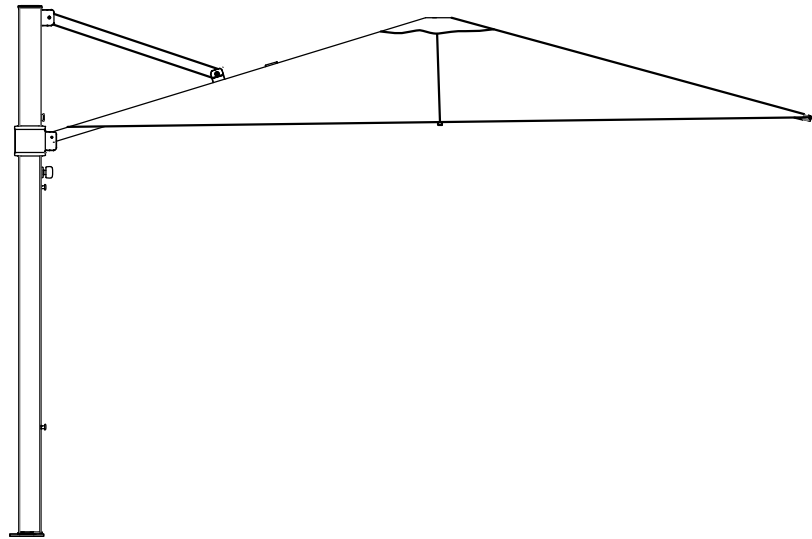

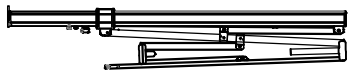

YA09 Instruction Manual

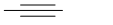
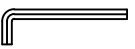
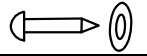
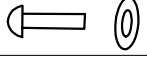

1.0

	Spare Parts List		Quantity
A			1
B			1
C			1
D		M12*25	1
E		8#	1
F			7
G			1
H			1

Note: base no included.

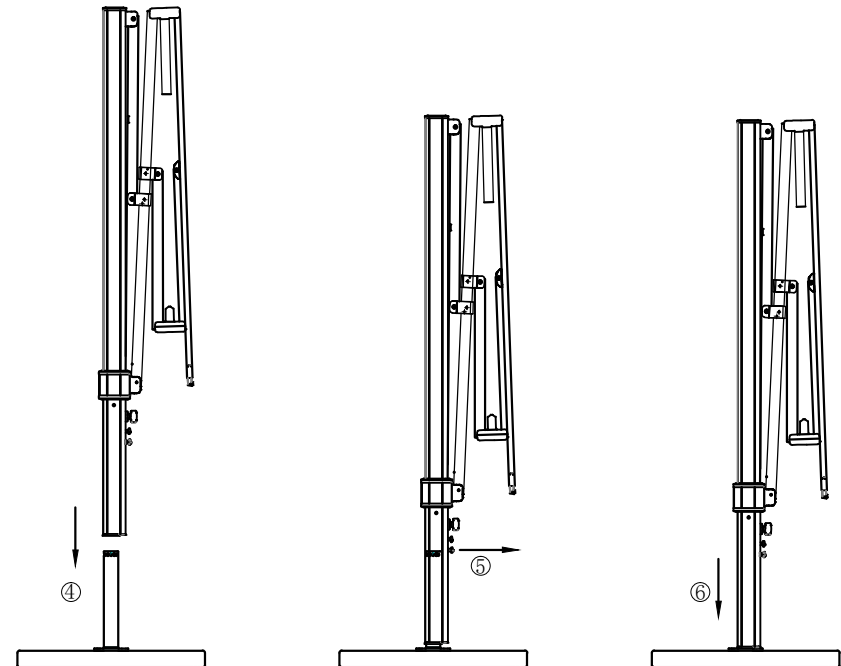
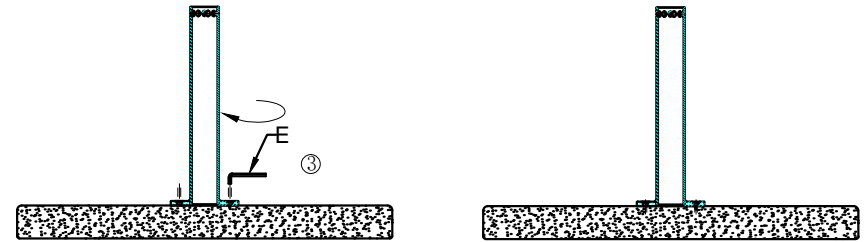
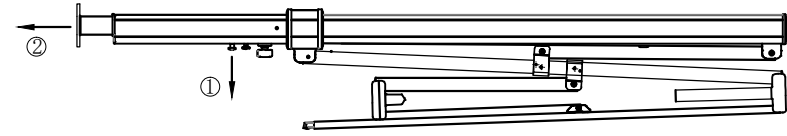

Note: base no included.

