

RAM *SPORT*

OWNER'S MANUAL

Contents

Instructions-----	1
Warnings-----	2
Explanatory Drawing of The Overall Bike Configuration-----	3
Schematic Diagram of The Electric Bicycle-----	4
Main Technical Parameters-----	5
Throttle Control-----	6
Shifting Gears-----	7
Operation Stages-----	8
Display, P.A.S and lights -----	9-11
Charging Methods and Steps-----	12
Battery Mounting and Dismounting-----	13
Front wheel installation and seat adjustment -----	14
Brakes-----	15
Pedals and Tire adjustment-----	16
Chain-----	17
Common Faults and Maintenance -----	18
Troubleshooting-----	19
FAQ-----	20
Contact us-----	21

Instructions

1. Please read the manual carefully before using the electric bicycle.
2. Make sure all parts are locked tightly, such as the frame joint, driver hand pipe, seat post and pedal, etc. before using. Do not use electric bicycle before carefully reading the instructions and knowing about the performance of the electric bicycle. Do not lend the electric bicycle to anyone who does not know how to operate it.
3. Develop a habit of charging when the power of the battery pack shows a red light. Please charge and maintain the battery pack consistently to have longer service; if the bicycle is not to be used for a long period, it is suggested that one must close the power of battery pack, and charge-discharge the battery once per month.
4. Frequent braking, starting, uphill, luff, still starting, muddy and uneven ground, overloading of people and goods will assume larger electricity, thus influencing the travel mileage. If you want to get the best travel mileage, we suggest you follow the following instructions:
 - Ride the bicycle to a certain speed by pedal, and then turn on the power.
 - Try to decrease the frequency of braking and starting while maintaining safe riding habits.
 - Please assist with pedal when the slope angle is steep, or the wind speed is fast.
5. When you lift the battery, please do not insert metal objects (such as lead wire, key etc.) into the charging socket or put them on the positive and negative contact point of battery cell. This can cause the battery to short-circuit, striking fire, and endangering personal safety.
6. This e-bike is not intended to be ridden through water. When the water level inundates the controller, electrical circuitry or motor hub, it is possible that it will cause short circuit and damage the circuit, please pay attention to avoid burning down the electronic control system!
7. The standard load weight of this bike is 250 lbs. (including the cyclist), overloading may cause the travel mileage to decrease, or cause the spare parts of the bike damage and reduce working life of battery.
8. If a charger which is not specially designed by our company is used to charge the battery pack, and spare parts are used that do not match the performance of the bike, should any accident occur, our company is not responsible for it.
9. If you disassemble or refit the bicycle and its spare parts, our company is not responsible for the loss caused by that, for which it is possible you may lose the warranty.
10. Pay attention to the illuminating state while driving at night, ride carefully and prevent accidents.
11. Minors, pregnant women and anyone with inconvenience of hands and legs should not use the electric bicycle.
12. Please check the tightening state of front axle, bottom bracket shell, rear axle, etc. frequently in use.
13. Children younger than 14 should not ride the electric bicycle.

Warnings

Please pay attention to the following items for your safety:

!	!
Disassembling and refitting the bicycle may bring hidden safety hazard to your electric bicycle, thus causing danger.	Make sure to check the safety and stability of the brake, saddle, frame, handlebar, wheel, etc. to avoid accidents.
!	!
Downhill speeding should be moderate, please do not use the front brake first when slamming the brakes at high speed to avoid gravity center forward, causing danger.	Avoid hitting uneven, muddy conditions or stairs in case of flat tire, deformation of wheel rim, thus damaging your electric bicycle and causing danger.
!	!
The brakes should not be oiled to avoid causing iffy brake, endangering personal safety.	Do not ride with objects on the handlebar to avoid operational error.
!	!
Please wear raincoat when driving on a rainy day, should not open an umbrella and operate the e-bike with one hand, please follow the traffic rules consciously.	This is a single person e-bike, not meant to be ridden with passengers, always wear a helmet.

Battery Notice! Warning

!	!
Do not keep, approach or store the battery close to fire, and avoid being near flammable, explosive and corrosive gas.	Do not attempt anything that could short-circuit the battery electrodes, which can damage the battery and cause danger.
!	!
Do not disassemble the battery case and tear up the decal on the battery case, the warranty will be voided.	Avoid external force, drop from high elevation, and immerse in water, damaging battery.

Battery Notice! Warning

!	!
Do not tamper or disassemble the charger. Avoid violent bumping or collision.	It is suggested that you charge in a ventilated environment, avoid humidity, and far away from flammable and explosive objects.
!	!
Please keep your hands dry while plugging and pulling the power plug to avoid electric shock.	While charging, there should be no foreign objects on the charger and/or the battery case.
!	!
Keep children away from the battery block and the charging place.	Avoid contact between the conductive objects and the battery poles at the same time to avoid short-circuit and damaging the battery.

Overall Bike Layout



Actual product may slightly differ from this picture

Diagram of the Electric Bicycle:

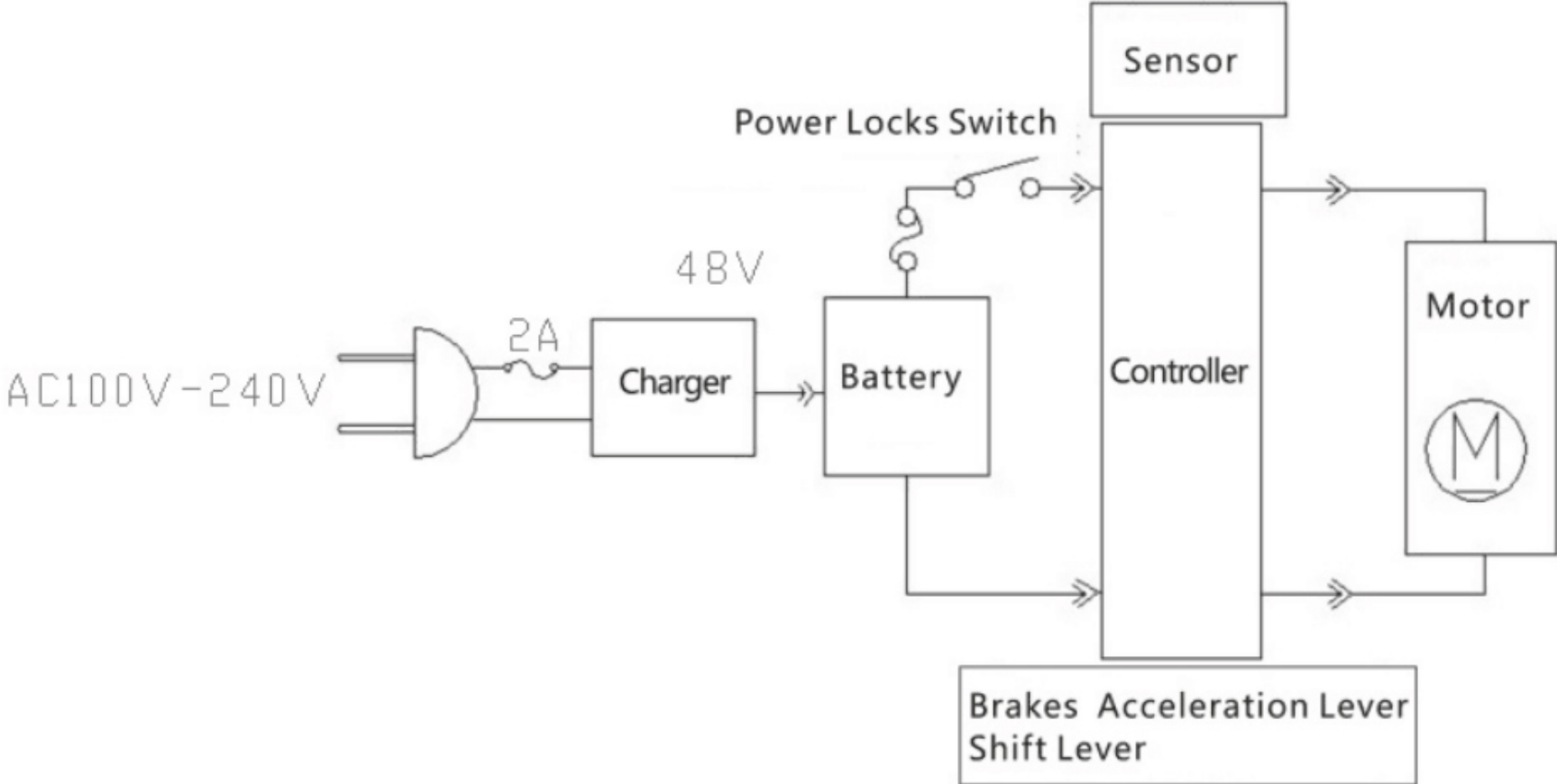

Main Technical Parameters

Item		Index	
Total Weight lbs.		< 55	
Load weight (including the Weight of Cyclist) lbs.		≤230	
Travel Mileage on a single Charge Miles w/pedal assist		Winter ≥ 25	Summer ≥ 40
Power Consumption on a single Charge (kilowatt)		< 0.6	
Power Consumption per Kilometer (kilowatt)		< 1.2	
Battery	Type	Lithium Ion Battery	
	Voltage / Capacity	48V10.4 Ah	
Motor	Motor Type	Permanent Magnet DC Hi-Speed Motor	
	Rated Output Power	750W	
	Rated Voltage	48V	
Controller	Under-voltage Protection	30.5V±0.5V/41.5 V±0.5V	
	Over-current Protection	15A±1A/17A±1A	
Charger	Model	48V 2A	
	Duration of Charge	Six to Eight Hours (Instant Charge two to four Hours)	
	Main Appliance Input Voltage	AC110-220±10%50HZ	
	Main Appliance Output voltage	42±0.2V/54.6±0.2V	
	Charging Current	2.0±0.2A	

Hand Throttle Control

Your EMOJO electric bike is equipped with a power and throttle control on the right hand side. To power on your bike first make sure the switch to your battery is in the ON position.

You control the throttle by pushing with your thumb the paddle, the farther you push from its resting position, the more power is delivered to the motor to accelerate.

When you want to slow down, you simply release the throttle and let it return to its resting position and simultaneously apply the brakes.



Thumb Throttle

When the pedal assist mode is set to “0”, the pedal assist and throttle function(s) do not engage. When the pedal assist mode is set to “5” the pedal assist function does not engage and the throttle will accelerate the bike forward. The throttle control is operated on the right hand side. You control the throttle by twisting it from its resting position. The farther the throttle switch is from its resting position, the more power is delivered to the motor to accelerate e-bike. When you want to slow down, you simply release the throttle and let it return to its resting position and simultaneously apply the brakes.

Gears

This EMOJO e-bike model is equipped with 7 speeds. The first gear is for easier and uphill pedaling, and the last gear is for maximum speed on level or downhill terrain. Change gears only while pedaling. The rear wheel contains seven chain sprockets. When the chain is around the largest sprocket, you are in 1st gear, or the lowest gear. The high gear will have the derailleur positioned so that the chain is directed around the smallest gear selector should cause a gear change. Adjustments require fine tuning and should only be made by a qualified technician.

Avoid changing gears very rapidly from first gear to the last gear or vice versa. If you change multiple gears too quickly, you could have the chain come off the front sprocket.



Thumb Shifter



7 Gears rear cassette

Correct Operation Stages

! Warning:

For your safety, please practice in open tracts the first time you ride. After mastering the controls of an electric bicycle, you may ride on regular roads and follow the traffic rules consciously. Do not let inexperienced people ride the electric bicycle, do not disassemble and refit the electric bicycle, please pay attention and brake in advance to allow longer braking distance in rainy or snowy weather.

Operation Stages:

Start: Turn the switch on the battery to the ON position. Turn the key clockwise. Press the power button (red button) on top of the battery to test your battery level. The battery level indicators will be turned on. 4 bars mean the battery is fully charged.



Motor On/Pedal Assist

Click the M button on for 2 seconds to turn on the system, start pedaling and the electric bicycle will drive forward normally. If you stop pedaling, the electric motor will stop working, but it will still drive forward a short distance because of inertia.



B: Throttle only

You can use the thumb throttle only and the bicycle will move without you having to pedal. Click the M button on the handlebar control to turn on the system, with your right thumb press down the throttle, the further you push the throttle the faster it accelerates. To stop or reduce the speed release the throttle and apply the brakes the electric motor will stop working, but it will still drive forward a short distance because of inertia.

Note: A: For your safety concern, please hold the grip tightly with both hands while riding, and please brake in a timely manner when necessary.

B: This bicycle has the function of brake power cut. The brakes will cut off the motor power to ensure safety of riding. Always check your brakes and cables before riding.

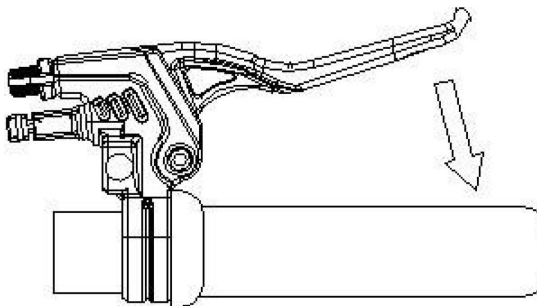

Pull to brake. Brake sensor will shut off motor power.

Display, P.A.S and lights

Please read the following steps and images to help you understand how to read and operate all the functions.

◆ Display Interface

After switching on the E-bike system, the display shows current speed and total distance except, battery indicator and assistance level

◆ To change the indicated information, press the MODE button to show in turn as follows: Current Speed (Km/h) → Trip Distance (Km) Trip Time (Hour) → Max. Speed (Km/h) → Avg. Speed (Km/h) → Motor-output (W) → Current Speed (Km/h).

◆ Switching PAS Off: There is a preset setting which allows your bike to cruise at a steady speed of 3.7 MPH (6Km/h), the letter "P" is shown at the screen. To engage this cruise control feature press and hold the "-" button for a few seconds until the letter "P" shows on the screen. To disengage this function press the brakes.

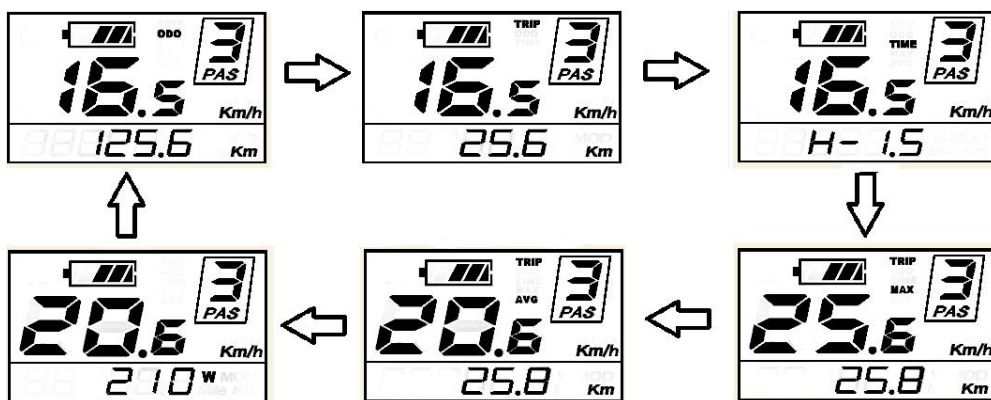

◆ There is a preset setting which allows your bike to cruise at a steady speed of 3.7 MPH (6Km/h), the letter "P" is shown at the screen. To engage this cruise control feature press and hold the "-" button for a few seconds until the letter "P" shows on the screen. To disengage this function press the brakes.

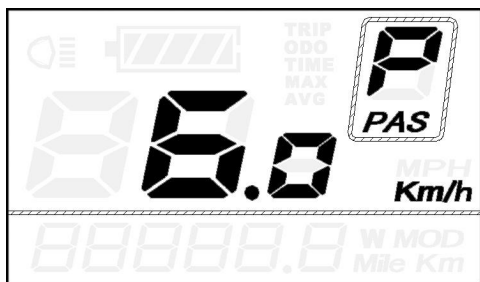

◆ Manual Clearance Function

Among of all functions, Trip Distance, Trip Time, Max. Speed and Avg. Speed, can only be cleared manually.

If the above functions need to be cleared, After switching on the E-bike system and parking the E-bike, please to hold the **MODE** button and the **DOWN** button for 2 s, the above functions can be cleared at the same time.

Press the power button (M button) on the LCD screen module located near the left grip on the handlebars to turn it on.

You can adjust the pedal assist power level to have more power by hitting the [+] button (right button) and can move to a lower level power by hitting the [-] button (left button).

When not riding your bike, you can turn off the meter by holding down the power button (M button) for several seconds.

LIGHTS

10- To turn the headlight/taillight ON, first make sure to turn on your system by pressing and holding the M button for 3 seconds, once the system is on press and hold the UP button until the light turns on, you will see the light icon on the screen appear.

To turn the lights OFF, press and hold again the UP button.



Pedal Assist Mode LCD Screen

The optional upgrade LCD meter monitors pedal assist, speed, odometer, trip distance, riding time, and battery energy level. To turn the meter on, make sure the battery is fully inserted into the bike and the on/off switch is in the on “On” position.

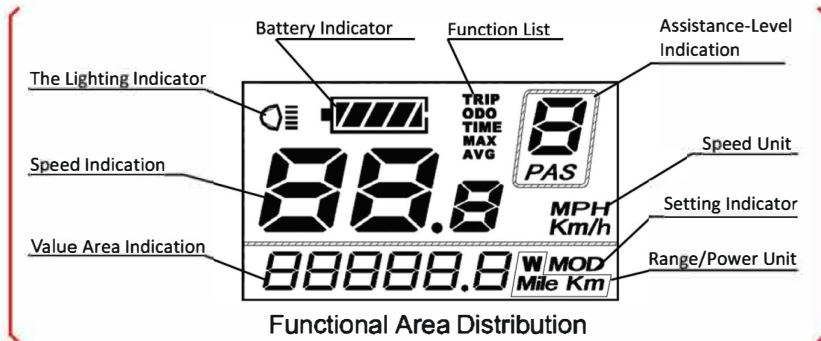

Press the power button (M button) on the two button selector located near the left grip on the handlebars to turn the meter on. You can adjust the pedal assist power level to have more power by hitting the [+] button (first button top to bottom) and can move to a lower level power by hitting the [-] button (third button top to bottom). When not riding the bike, you can turn off the meter by holding down the power button (M button) for several seconds.

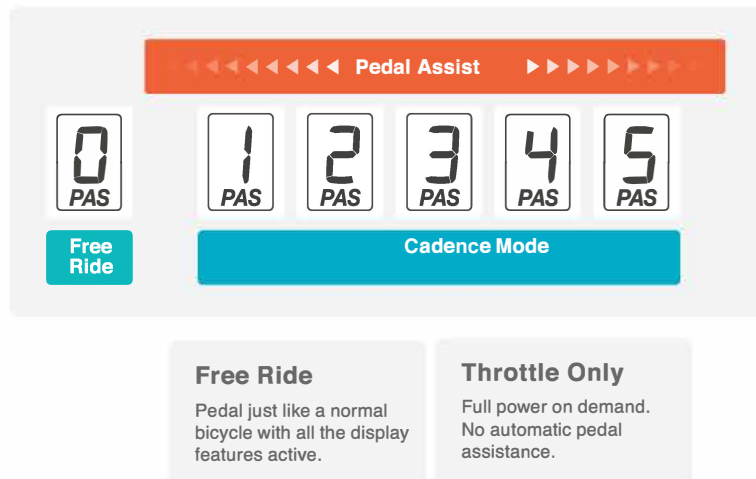

Display functions

1-Power On/Off

Press the M button to power on the display. To power off display and power supply to the bicycle press and hold for 3 seconds

3-Riding Mode

The system has 5 PAS assistance modes, use the + -buttons to scroll between modes

4-Distance Display

Press the M button once to switch between ODO/TRIP RANGE

5-Riding Time

The riding time will be saved up to 100 hours unless you reset it

6-Battery Level Indicator

Indicates battery level, there are 5 levels, each segment stands for 20% charge

7-Speed Indicator

Shows the speed either in MPH or KM/h

8-PAS Level

Indicates the level of motor assistance. Use the + - buttons to switch between PAS levels

Error Codes

In the event of a system malfunction the screen will display an error code. You can troubleshoot the problem by identifying the code from the following list:

Error Code	Definition
21	Current Abnormality
22	Throttle Abnormality
23	Motor Abnormality
24	Motor Hall Signal Abnormality
25	Brake Abnormality
30	LCD Communication Abnormality

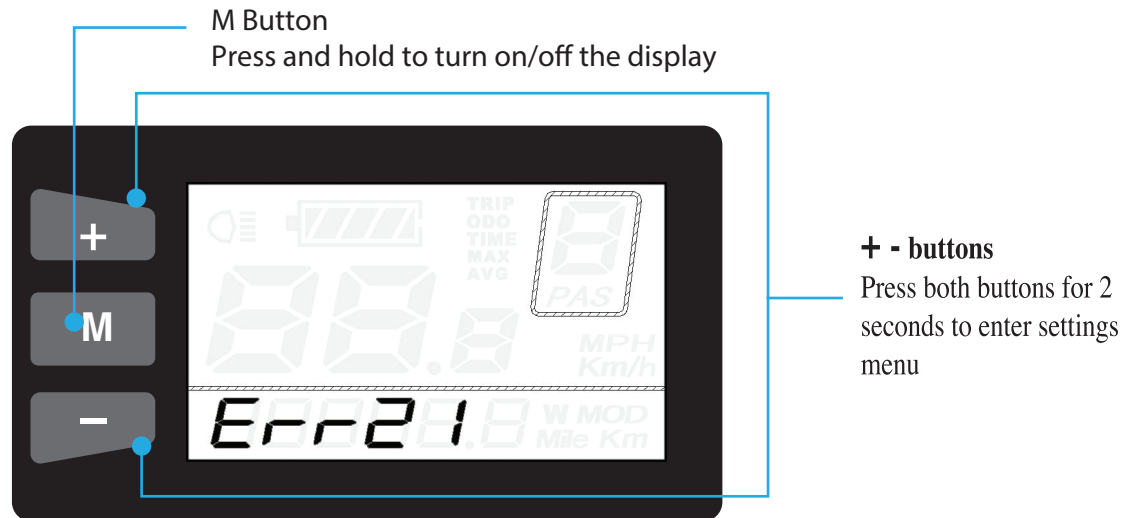

The display will turn off after 10 minutes of inactivity

Charging Methods and Steps

1. Always charge the battery fully for the first time. When the battery level is low plug it to charge it, use only the original charger provided with the battery.



2. Insert the charging pin of the charger into the battery charging plug; pay attention to the direction of the pins, do not insert any other foreign objects or dismantle

3. Connect the power plug of charger into a household AC power outlet. Please do not insert the plug into the AC around water or with wet hands, avoid causing electric shock hazards.

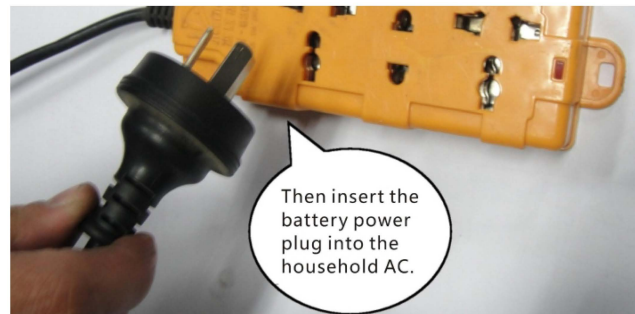

4. Please check the charger indicator. When the LED indicator on the charger is red, it indicates the battery is charging, when the indicator is green, it indicates charging completed.



5. After charging completes, please pull out the charger power plug from the household AC and disconnect the plug from the battery

Attention:

1. Make sure the charger is the original charger.
2. All charging plugs must be inserted tightly.
3. The average charging time of the whole battery pack is 6-8 hours, please operate in strict accordance with above instructions and keep charger away from children.
4. Please do not charge under the rain or in wet environments.

Battery mounting and removal

1. installing the Battery

Insert the battery into the designated area behind the seat pole, aligning the battery guide and bottom power socket. After hearing a click, the battery is properly installed. Use the provided keys to lock the battery to the frame.



Bottom socket

2. Battery removal

Park the electric bicycle, unlock the battery switch until the key cylinder in the battery pack is completely free from the hole on battery case slider, then hold the battery handle and pull out battery pack.

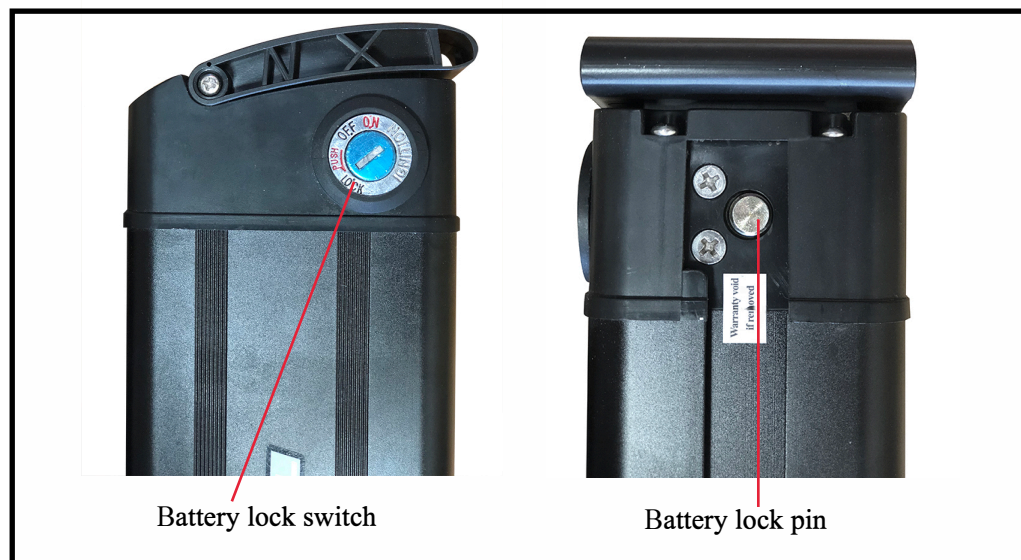

Battery lock switch

Battery lock pin

Note: While installing and removing, do not use extreme force to avoid damaging the battery pack and other components.

Front wheel installation

Read the instructions carefully to identify and understand the components of the electric bicycle such as pedal, seat post etc. and the name of relevant spare parts. When specialized servicing of bike is required, please go to an authorized EMOJO repair shop or store or another trusted bike professional.

1. Assembly of the front wheel unit:

Identify the nuts and the lock washers (Fig A) necessary for the front axle assembly.

Assemble the front wheel unit onto the front fork, pass the lock washers thru the axle and lock the tab into the groove of the front fork (fig. B). Tighten the nuts on both sides of the hub with a wrench (fig C). Attention: when assembling, make sure the disc brake and the brake caliper are on the same side (left side), the disc brake must slide into the gap between the two brake pads of the disc brake caliper, make sure the wheel turns freely and does not rub against the brake pads when the front brake is not been pressed.



Fig A.

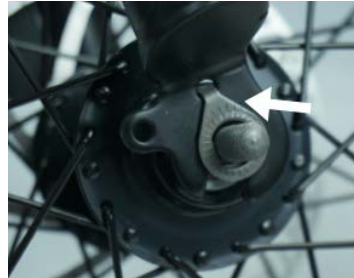
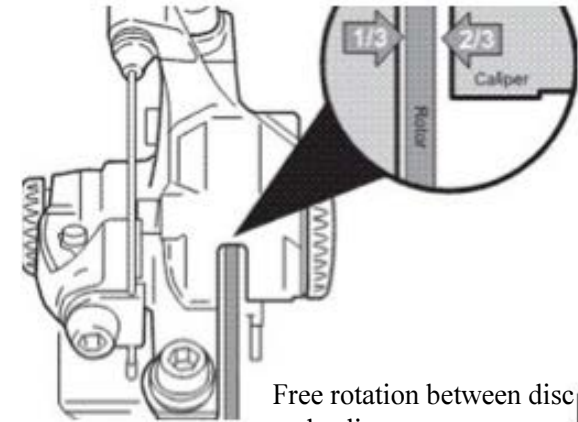

Fig B.



Fig C.



Free rotation between disc
and caliper.

2 Front wheel quick release:

You can easily remove the front wheel of your bicycle to facilitate transportation or storage, use the quick release lever to loosen the front wheel and remove.

IMPORTANT: Always make sure your quick release lever is fully tight once putting the wheel back on and before riding.



3. Adjustment of Saddle:

Adjust the saddle to the proper height. Using the socket hand wrench, lock the fixed screws on the seat post and clamp tightly. Please note that when adjusting the height of the standpipe and seat post, it has to keep the inserting depth above the safety line.

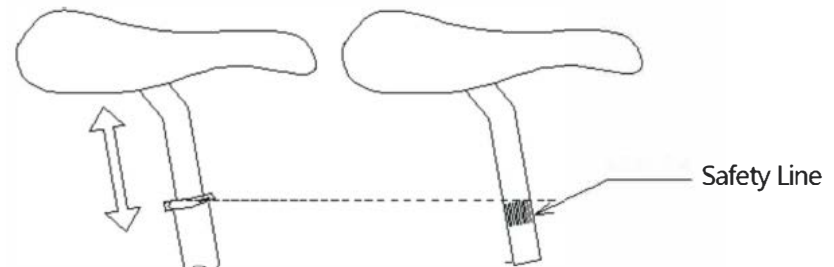

Disc Brakes

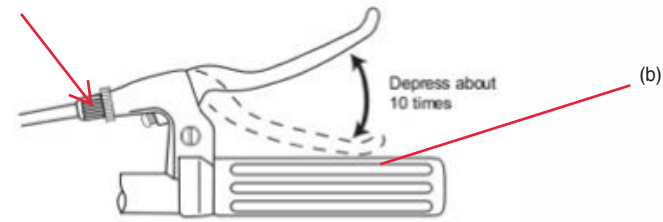

Figure 1

Your EMOJO e-bike is equipped with disc brakes for maximum reliability. Applying hand pressure to the brake levers will engage the brake pads against the brake rotor, creating friction and slowing down the wheel. The more hand pressure applied to the brake lever, the faster the bike will come to a stop.

Check the front disc handle gap by depressing the brake lever about 10 times to check that everything is operating correctly (Fig. 1) If necessary you can adjust the brake by turning the dial on cable (shown with a red arrow). Your front wheel must spin free at all times without any friction from the brake when not applied.

The rear brake should always be applied before or along with the front brake. Applying only the front brake to slow or stop at high speeds may result in the rider being ejected from the saddle and continuing forward over the handlebars. It is best to apply even pressure to both brake levers when slowing or stopping.

Bicycles equipped with disc brakes will occasionally make a slight scraping noise when the wheels are turning without the brakes being applied. This is normal.

Make sure that the brake lever does not contact the handlebar when full hand pressure is applied (b) The contact point should feel firm and solid. If the lever travels all the way to the handlebar or feels spongy, they may require service by a qualified bicycle technician.

If the brakes are still not operating correctly, they may require further adjustment by an experienced bicycle mechanic.

WARNING:

- Disc brake rotors become hot during use. Do not touch or come in contact with the disc rotor shortly after use.
- Wet weather will require a longer distance to stop. Brake earlier and avoid sudden stops when riding in wet conditions.

New Brakes Bed-in Procedure

New brakes will require a “bed-in” procedure prior to your first ride which will ensure the most consistent and powerful braking feel.

- 1 Find a safe riding area that will allow for moderate speed. Remain seated during the entire procedure for optimal results.

Important Note: Do not lock up the wheels at any point during the bed-in procedure.

- 2 Accelerate the bike to a moderate speed, then firmly squeeze the brake levers until you are at walking speed. Repeat this process about twenty times.

Accelerate the bike to a faster speed, then firmly squeeze the brake levers until you are at walking speed. Repeat this process about ten times.

Allow the brakes to cool down before your first ride.

4. Pedal Installation and Adjustment:

Take out pedals from the accessory box, install one of the pedals (pedals are marked with the letters “L” and “R” to indicate the side they belong to). When installing the pedals, insert the wrench stuck on the flat end of pedal axial head, and twist into the crank in clockwise direction.

5. Check and Adjustment of Tire Pressure

Keep proper air pressure, the space between tire and ground contact is about 10 centimeters long when riding on the electric bicycle.

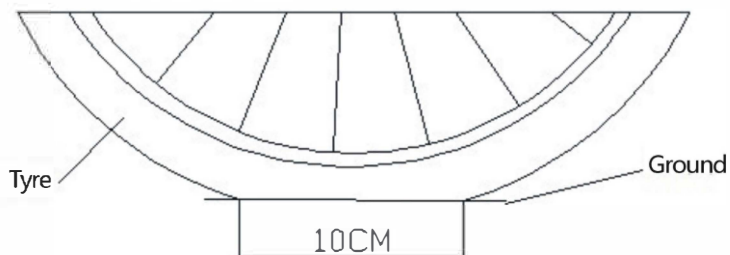

Tire size: 20 x 4.0 K1188

Tube size: 20 x 4.0

The Standard Tire Pressure : 40 PSI

6. Brake Adjustment

A. When brake lever reaches 1/3 of unstressed state, the power will be cut out completely, when it is at 1/2, bike can brake completely.

B. The distance between brake pad of front wheel and rim should not be more than 2mm, when the brake pads wear down, timely adjustment is possible, after adjustment, the brake pad should not interfere with other spare parts. When a worn brake pad reaches 1/2 of its thickness, it must be replaced.

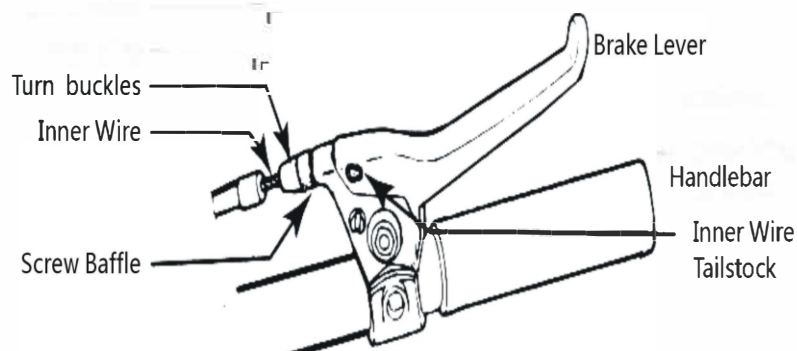

7. Adjustment of Power Assisting Hall Sensor

A: Turn the bike upside down, have it rest on the floor.

! The distance between the sensor and the disk shall be 3-5 millimeters

: Installing the sensor on the side of chain ring, when forwarding the chain ring, the power assistance is effective.

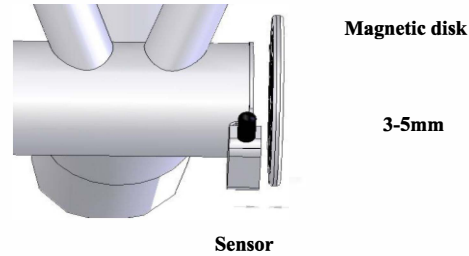

8. The Adjustment of Chain Tension The over relaxation of the check and adjust regularly. The chain would cause chain failing thus threatening safety or damaging the motor. It is suggested to adjustment requirements: in case of single constant speed, when fixed gear, press the chain with hand, the range of the tension is within 10mm from horizontal line.

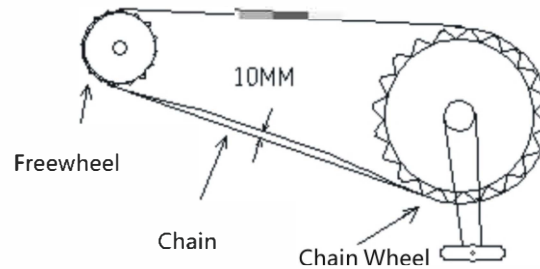

Common Faults and Maintenance

Common Faults	Troubleshooting
Power on, there is no indicator on meter: Push thumb throttle, the motor does not work:	Check the battery power, if battery is low, it is possible that the power will fail, or some blown fuses of the controller are burned out.
	Check whether the speed controlling wire of left brake levers fail, and whether the connector of the controller or motor fails.
Motor kicks in, but speed is low	Check whether the brake is locked, the tightness of chain is proper; the air pressure of tire is proper; check whether the battery power is full, if not, please charge the battery.
Short Mileage	If the battery has not been in use for a long time, please recharge the battery in advance. Check whether the brake rubs against the rim because of tightness, and whether the tire pressure is full. Check whether the battery is full, if not, please recharge it.
Abnormal Noise of the Bike	Check for all screws and bolts to be properly tightened.

Battery Not Charging	Check the charger and power. Check whether the battery connection is in good condition and is stable. Check whether the charger plugs board fails. Check for any blown fuses in the battery case or any disconnected wiring.
----------------------	--

Note: if you experience problems contact your retailer, dealer or the manufacturer.

Regular Maintenance Table

I: Inspection A. Adjust R: Replace L: Lubrication T: Tight lock			
Items to be Inspected	60 days	180 days	360 days
1.If the steering of handlebar loosens or wears down	A, T	I, L2	I, L2
2. If pedal, axis loosens or wears down	T	I, L1	I, L1
3. If the tire inflation is proper and the cover tire wears down		I	R
4. If anterior- posterior axis shift, axis bowl, hub spindle loosens or wears down	T	I, L2	I, L2
5. If middle axis bowl, hub spindle, axle cap loosens or wears down	A, L1	A, L1	I, L1
6. If the chain is loose	A, L2	A, L2	I, L2
7. If the brake shoe wears down		R	R
8. If the wheel rim deflects or deforms		I	I
9. If the frame and front fork deform or are damaged		I	I
10. If spokes break down or becomes loose		I	I
11. If the brake operates smoothly	I	I	I
12. If brake lever is at its proper position	A	A	A
13. If the reflector is dirty or damaged		I	I
14. If the horn is loud or the front light is bright		I	I
15. If the charger plug and power line wears down or breaks off			I
16. If the height of saddle and handlebar is proper	A	A	A
17. All screws positions are tight	I	I, T	T

**Note: L1- recommends using No.68 HL hydraulic Lubricant
L2- recommends using No2. Calcium-based Grease.**

Power Shut Off Troubleshooting

If your EMOJO RAM SS experiences a sudden power shut off while in use, this can be related to several reasons but the problem has an easy fix.

PROBLEM

The LED module on the handlebar starts to blink repeatedly followed by a power shut off. (Make sure the battery is not depleted)

DIAGNOSTIC

1- Check the battery directly, press the power button to check how much power is left.



2-Open the controller box under the bike (Fig 1), retrieve the controller and check all wiring connections (Fig 2):



Fig. 1

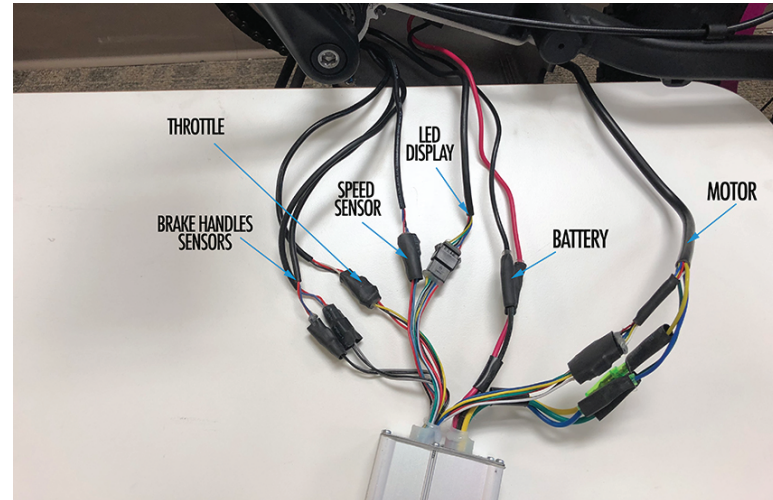

Fig. 2

- Disconnect the brake handle sensors from the controller box, turn the LED display at the handlebar, if it continues to blink reconnect the wires and move to the next step.
- Disconnect the throttle sensor from the controller box, turn the LED display at the handlebar, if it continues to blink reconnect the wires and move to the next step.
- Disconnect the speed sensor from the controller box, turn the LED display at the handlebar, if it continues to blink there could be a problem with the controller box and would need to be replaced.

3-Check the power quick disconnect plug on the rear right side section of the frame

Quick Disconnect (Rear frame section)



Electric Bike FAQs

Q. How long does it take to fully charge the battery?

A. Depends on the state of discharge but around 4-5 hours if completely discharged.

Q. What are the running costs for an EMOJO electric bike?

A. You will have no worries about rising fuel prices at the pumps. All our electrically powered vehicles use household electricity. The average cost per full charge is about 10 cents per charge. If you charge the battery every single day for a year, it would cost you about \$35 per year.

Q. Can I ride up hills and against strong headwinds on my EMOJO electric bike?

A. Yes. One of the main advantages of cycling on an EMOJO electric bicycle is that it literally flattens hills and increases your average speed when tackling inclines and headwinds. If you provide a reasonable amount of effort, you should be able to tackle anything from a 1 in 10 (10%) gradient up to a 1 in 7 (14%) gradient. Pedaling along with the motor is strongly advised to avoid overheating of the motor and to extend the battery life.

Q. Do I need a driver's license, insurance or registration?

A. No, you don't. According to Federal law, electric bikes that are under 750 watts are classified as bicycles. For all intents and purposes, it's simply a bicycle that requires very little pedaling to travel 20 MPH (32 Km/H), saving you time and hassle. Check your local state laws for requirements.

Q. Do I need to pedal an electric bike?

A. No, but it helps to prolong battery life. The motor on our bikes is both throttle and pedal assist controlled, allowing you to decide how much power you desire. Have you ever tried to cycle when speeding downhill on your normal bicycle? It's just like that. The motor is propelling you faster than you're cycling so there is pretty much no resistance, it's merely a formality!

Q. What happens if I get a flat tire?

A. The tires on our bikes are the same as conventional bicycles. Simply replace the tube with a tube of the right size and inflate it. No special tires or parts will be needed.

Q. What happens when I use the brakes under powered assistance?

A. All our bikes are equipped with brake levers that have a built-in safety switch that automatically cuts off the motor power under normal braking conditions. This not only ensures a safe un-powered stopping feature, but also protects the motor under braking conditions so that it isn't working against the brakes.

Q. How far will the bike take me?

A. This all depends on a few factors. Cycling with pedal assist along a straight road under normal conditions, the standard battery should last about 31 miles (50 kilometers). Cycling up steep hills will obviously take more energy out of the battery and factors such as road surface, wind resistance, weight of the rider and tire pressure will affect your range. The range with throttle only lasts about 20 miles (35 km)

Q. How do I know when the battery is low?

A. The bicycles have easily visible indicators located on the meters that show the amount of juice left. If it is getting low and you don't think you will make it to your destination, you can switch off your motor and keep it just for the difficult bits.

Q. Do I have to wait for the battery to empty before I charge it?

A. No. The batteries we use are Lithium-ion batteries which do not suffer from 'memory effect'. This means that there is no need to discharge a battery completely before you recharge it again. You can partially recharge the battery at any time without reducing its voltage or lifespan. We recommend recharging the battery after every use, regardless of how far you rode.

Q. Can I put a child's trailer?

A. Yes, you can certainly add a trailer to your bike. We suggest contacting your local dealer for approved trailers.

Q. Can I put the electric bike on a bike rack?

A. Yes, just make sure that the bike rack can hold the weight of the bike. We advise taking the battery off to make it easier to lift and to keep the battery safe.

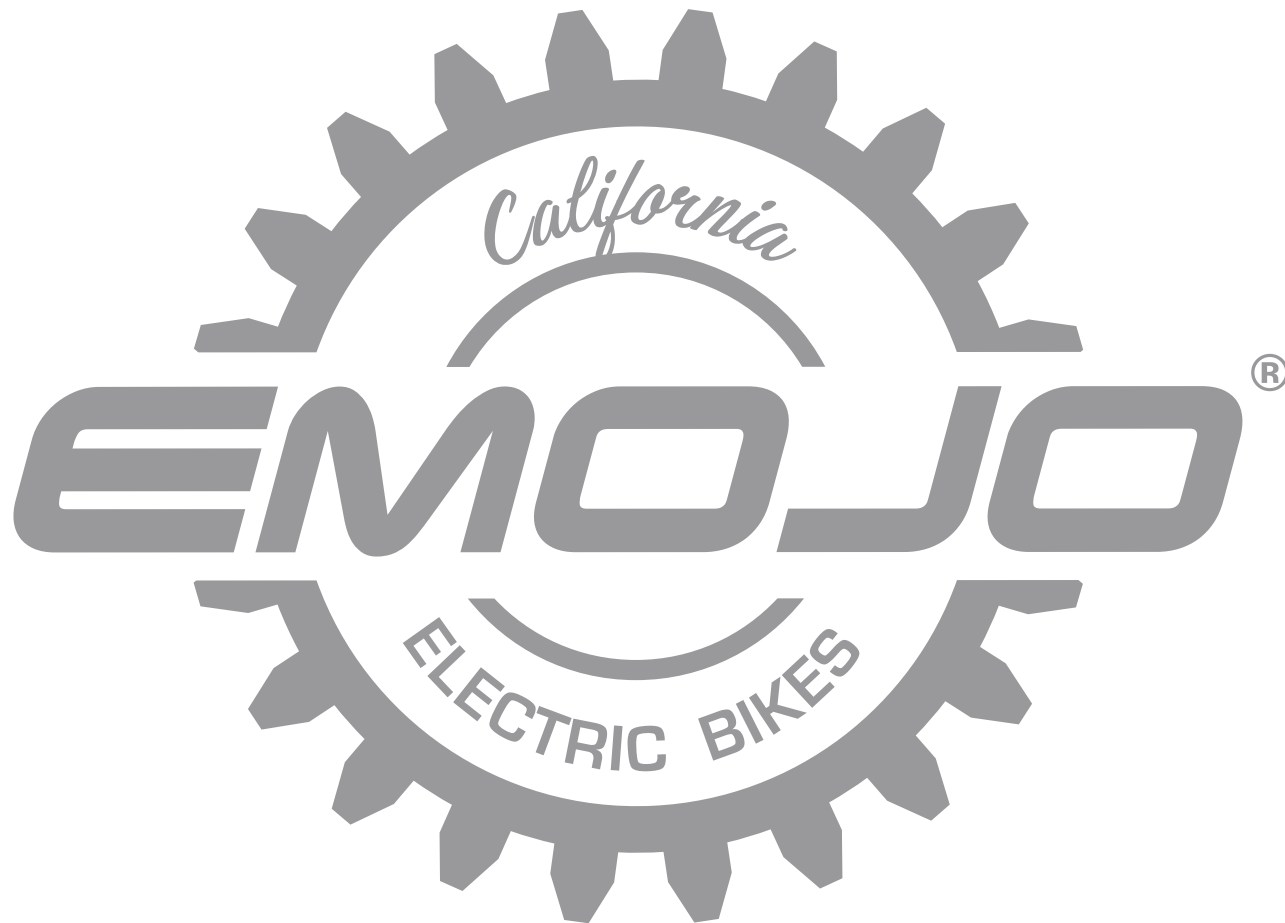

At EMOJO we are committed to the consumers and the experience first, put a smile on the face of each of EMOJO rider and revive childhood memories when riding a bike meant freedom regardless of your age or gender, life doesn't stop and neither should you, that's why we say: "RIDE LIFE"
Should you have any comments, questions or just want to say hi, feel free to throw us an email or give us a call:

 15375 Barranca Parkway
Suite F 108
Irvine, CA 92618 USA

 949.878.1518

 info@emojobike.com
support@emojobike.com

 emojobike.com