















# TG-X E6D 2020 ON

## FOR MAN



<p><b>ZC-M14-001</b>            面板            PANEL            81611106112 81611106164            TG-X E6D 2020 on</p> 	<p><b>ZC-M14-002</b>            面板亮条            GRILLE STRIP            81611506144            TG-X E6D 2020 on</p> 	<p><b>ZC-M14-003</b>            面板格栅板            GRILLE            81611506145            TGS E6D</p> 
<p><b>ZC-M14-004</b>            字牌            MARK            81978402123 81978402124            81978402125            TGS E6D</p> 	<p><b>ZC-M14-005</b>            面板开关 LH            PANEL HINGE LH            81611405040            TG-X E6D 2020on</p> 	<p><b>ZC-M14-006</b>            面板铰链 LH            PANEL HIAGE LH            81611456011 LH            TG-X E6D 2020on</p> 
<p><b>ZC-M14-007</b>            面板铰链 RH            PANEL HIAGE RH            81611456010 RH            TG-X E6D 2020on</p> 	<p><b>ZC-M14-008</b>            扩展格栅面板            GRILLE            81611506128 81611506146            TG-X E6D 2020on</p> 	<p><b>ZC-M14-009</b>            外包角 LH            PANEL CORNER LH            81611100155 LH            81611100089            TG-X E6D 2020on</p> 
<p><b>ZC-M14-010</b>            外包角 RH            PANEL CORNER RH            81611100154 RH            TG-X E6D 2020on</p> 	<p><b>ZC-M14-011</b>            外包角 LH            PANEL CORNER LH            81611100157 LH            TG-X E6D 2020on</p> 	<p><b>ZC-M14-012</b>            外包角RH            PANEL CORNER RH            81611100156 RH            TG-X E6D 2020on</p> 
<p><b>ZC-M14-013</b>            大灯框 (高配带大灯清洗口) LH            HEAD LAMP CASE LH            81416105833 LH            TG-X E6D 2020on</p> 	<p><b>ZC-M14-014</b>            大灯框 (高配带大灯清洗口) RH            HEAD LAMP CASE RH            81416105832 RH            TG-X E6D 2020on</p> 	<p><b>ZC-M14-015</b>            大灯框LH            HEAD LAMP CASE LH            81416105825 LH            TG-X E6D 2020on</p> 

FOR MAN

TG-X E6D 2020 ON



**ZC-M14-016**

大灯框 RH  
HEAD LAMP CASE RH  
81416105824 RH  
TG-X E6D 2020on



**ZC-M14-017**

雾灯框 LH  
FOG LAMP CASE LH  
81416105823LH  
TG-X E6D 2020on



**ZC-M14-018**

雾灯框 RH  
FOG LAMP CASE RH  
81416105822 RH  
TG-X E6D 2020on



**ZC-M14-019**

雾灯框饰板 LH  
FOG LAMP CASE COVER LH  
81416100985 LH  
TG-X E6D 2020on



**ZC-M14-020**

雾灯框饰板 RH  
FOG LAMP CASE COVER RH  
81416100984 RH  
TG-X E6D 2020on



**ZC-M14-021**

大灯盖板 LH  
HEAD LAMP COVER LH  
81416100993 LH  
TG-X E6D 2020on



**ZC-M14-022**

大灯盖板 RH  
HEAD LAMP COVER RH  
81416100992 RH  
TG-X E6D 2020on



**ZC-M14-023**

雾灯盖板 LH  
FOG LAMP COVER LH  
81416100983 LH  
TG-X E6D 2020on



**ZC-M14-024**

雾灯盖板 RH  
FOG LAMP COVER RH  
81416100982 RH  
TG-X E6D 2020on



**ZC-M14-025**

杠饰板侧 LH  
BUMPER COVER SIDE LH  
81416100991  
81416100989LH  
TG-X E6D 2020on



**ZC-M14-026**

杠饰板侧 RH  
BUMPER COVER SIDE RH  
81416100990  
81416100988 RH  
TG-X E6D 2020on



**ZC-M14-027**

保险杠大灯底座  
BUMPER HEAD LAMP BASE  
81416105821  
TG-X E6D 2020on



**ZC-M14-028**

保险杠中段下饰板  
BUMPER GARNISH  
81416140097  
TG-X E6D 2020on



**ZC-M14-029**

踏板中央保险杠  
BUMPER STEP MIDDLE  
81416140099  
TG-X E6D 2020on



**ZC-M14-030**

杠下装饰件  
BUMPER UNDER BAR TRIM  
81416100757  
TG-X E6D 2020on



# TG-X E6D 2020 ON

## FOR MAN



### ZC-M14-031

面板装饰上层/面板装饰中层/面板装饰下层面板装饰着下部  
 PANEL DECORATION UPPER LAYER / PANEL DECORATION  
 MIDDLE LAYER / PANEL DECORATION LOWER LAYER PANEL  
 DECORATION LOWER LAYER  
 81416140104 81416140105  
 81416140106 81416140107  
 TG-X E6D 2020on



### ZC-M14-032

空气偏转器下部  
 LOWER PART OF AIR DEFLECTOR  
 81416140185  
 TG-X E6D 2020on



### ZC-M14-033

空气偏转器 LH  
 AIR DEFLECTOR LH  
 81416140227LH  
 TG-X E6D 2020on



### ZC-M14-034

空气偏转器RH  
 AIR DEFLECTOR RH  
 81416140228 RH  
 TG-X E6D 2020on



### ZC-M14-035

空气导流板 LH  
 AIR DEFLECTOR LH  
 81416140229 LH  
 TG-X E6D 2020on



### ZC-M14-036

空气导流板RH  
 AIR DEFLECTOR RH  
 81416140230 RH  
 TG-X E6D 2020on



### ZC-M14-037

杠格栅高配带亮条  
 BUMPER GRILLE AND HIGH  
 CONFIGURATION WITH LIGHT  
 81416146084  
 TG-X E6D 2020on



### ZC-M14-038

杠格栅低配不带亮条  
 BUMPER GRILLE LOW  
 CONFIGURATION WITHOUT LIGHT  
 81416146085  
 TG-X E6D 2020on



### ZC-M14-039

杠格栅亮条  
 BUMPER GRILLE LIGHT  
 81416140256  
 81416140257  
 81416140258  
 TG-X E6D 2020on



### ZC-M14-040

杠雷达盖  
 BUMPER RADAR COVER  
 81416140098  
 TG-X E6D 2020on



### ZC-M14-041

大灯清洗盖LH  
 HEADLAMP CLEANING COVER LH  
 81416100999 LH  
 TG-X E6D 2020on



### ZC-M14-042

大灯清洗盖RH  
 HEADLAMP CLEANING COVER RH  
 81416100998 RH  
 TG-X E6D 2020on



### ZC-M14-043

杠支架LH  
 BUMPER BRACKET LH  
 81416100981 LH  
 TG-X E6D 2020on



### ZC-M14-044

杠支架RH  
 BUMPER BRACKET RH  
 81416100980 RH  
 TG-X E6D 2020on



### ZC-M14-045

前大灯LED LH  
 HEAD LAMP LED LH  
 81251016813 LH  
 TG-X E6D 2020on



# TG-X E6D 2020 ON

## FOR MAN



### ZC-M14-046

前大灯LED RH  
HEAD LAMP LED RH  
81251016814 RH  
TG-X E6D 2020on



### ZC-M14-047

前大灯灯泡LH  
HEAD LAMP BULB TYPE LH  
81251016737 LH  
TG-X E6D 2020on



### ZC-M14-048

前大灯灯泡RH  
HEAD LAMP BULB TYPE RH  
81251016738 RH  
TG-X E6D 2020on



### ZC-M14-049

前大灯灯泡低配 LH  
HEAD LAMP BULB TYPE LOW LH  
81251016731 LH  
TG-X E6D 2020on



### ZC-M14-050

前大灯灯泡低配 RH  
HEAD LAMP BULB TYPE LOW RH  
81251016732 RH  
TG-X E6D 2020on



### ZC-M14-051

防雾灯LED LH  
FOG LAMP LED LH  
81252040003 LH  
TG-X E6D 2020on



### ZC-M14-052

防雾灯LED RH  
FOG LAMP LED RH  
81252040004 RH  
TG-X E6D 2020on



### ZC-M14-053

防雾灯灯泡 LH  
FOG LAMP BULB TYPE LH  
81252040001 LH  
TG-X E6D 2020on



### ZC-M14-054

防雾灯灯泡RH  
FOG LAMP BULB TYPE RH  
81252040002 RH  
TG-X E6D 2020on



### ZC-M14-055

大灯PC灯罩 LH  
HEAD LAMP PC COVER LH  
TG-X E6D 2020on



### ZC-M14-056

大灯PC灯罩 RH  
HEAD LAMP PC COVER RH  
TG-X E6D 2020on



### ZC-M14-057

雾灯PC灯罩LH  
FOG LAMP PC COVER LH  
TG-X E6D 2020on



### ZC-M14-058

雾灯PC灯罩RH  
FOG LAMP PC COVER RH  
TG-X E6D 2020on



### ZC-M14-059

前叶子板LH  
FRONT FENDER LH  
81615200087 LH  
81615200083 81615200085  
81615200089  
TG-X E6D 2020on



### ZC-M14-060

前叶子板RH  
FRONT FENDER RH  
81615200086 RH  
81615200082 81615200084  
81615200088  
TG-X E6D 2020on



# TG-X E6D 2020 ON

## FOR MAN



### ZC-M14-061

前叶子板灯LH  
FRONT FENDER LAMP LH  
81253206125 LH  
TG-X E6D 2020on



### ZC-M14-062

前叶子板灯RH  
FRONT FENDER LAMP RH  
81253206126 RH  
TG-X E6D 2020on



### ZC-M14-063

前叶子板装饰条 LH  
FRONT FENDER STRIP LH  
81612100929 LH  
TG-X E6D 2020on



### ZC-M14-064

前叶子板装饰条 RH  
FRONT FENDER STRIP RH  
81612100928 RH  
TG-X E6D 2020on



### ZC-M14-065

前挡泥板装饰条 LH  
FRONT MUDGUARD STRIP LH  
81612100909 LH  
TG-X E6D 2020on



### ZC-M14-066

前挡泥板装饰条 RH  
FRONT MUDGUARD STRIP RH  
81612100910 RH  
TG-X E6D 2020on



### ZC-M14-067

车门下护板LH  
GRILLE LH  
81626106015 LH 81626100079  
TG-X E6D 2020on



### ZC-M14-068

车门下护板RH  
LOWER DOOR GUARD  
81626106016 RH  
81626100080  
TG-X E6D 2020on



### ZC-M14-069

车门下装饰条 LH  
LOWER DOOR GUARD LH  
81626100057 LH  
TG-X E6D 2020on



### ZC-M14-070

车门下装饰条RH  
DOOR LOWER TRIM RH  
81626100058 RH  
TG-X E6D 2020on



### ZC-M14-071

前叶子板内隔音棉LH  
INNER SOUND INSULATION COTTON  
OF FRONT FENDER LH  
81615102479 LH  
TG-X E6D 2020on



### ZC-M14-072

前叶子板内隔音棉 RH  
INNER SOUND INSULATION COT-  
TON OF FRONT FENDER RH  
81615102480 RH  
TG-X E6D 2020on



### ZC-M14-073

前轮挡泥板支架LH  
FRONT MUDGUARD BRACKET LH  
81612430165 LH  
TG-X E6D 2020on



### ZC-M14-074

前轮挡泥板支架RH  
FRONT MUDGUARD BRACKET RH  
81612430164RH  
TG-X E6D 2020on



### ZC-M14-075















车门LH  
DOOR LH  
81626004139 LH  
TG-X E6D 2020on



**FOR MAN**

**TG-X E6D 2020 ON**



<p><b>ZC-M14-076</b>          车门RH          DOOR RH          81626004140RH          TG-X E6D 2020on</p> 	<p><b>ZC-M14-077</b>          台阶防滑板LH          STEP LH          81615110035          TG-X E6D 2020on</p> 	<p><b>ZC-M14-078</b>          下脚踏板LH          UPPER STEP LH          81615200073 LH 81615200075          TG-X E6D 2020on</p> 
<p><b>ZC-M14-079</b>          下脚踏板RH          UPPER STEP RH          81615200066 RH          81615200074          TG-X E6D 2020on</p> 	<p><b>ZC-M14-080</b>          下脚踏板LH          UPPER STEP LH          81615200073 LH 81615200075          TG-X E6D 2020on</p> 	<p><b>ZC-M14-081</b>          下脚踏板          UPPER STEP RH          81615200066 RH 81615200074          TG-X E6D 2020on</p> 
<p><b>ZC-M14-082</b>          下脚踏板铝支架          UPPER STEP ALUMINIUM BRACKET LH          81615110027 LH          TG-X E6D 2020on</p> 	<p><b>ZC-M14-083</b>          下脚踏板前支架LH          UPPER STEP FRONT BRACKET LH          81615110023 LH          TG-X E6D 2020on</p> 	<p><b>ZC-M14-084</b>          下脚踏板后支架LH          UPPER STEP REAR BRACKET LH          81615110025 LH          TG-X E6D 2020on</p> 
<p><b>ZC-M14-085</b>          下脚踏板铝支架          UPPER STEP ALUMINIUM BRACKET RH          81615110026RH          TG-X E6D 2020on</p> 	<p><b>ZC-M14-086</b>          下脚踏板前支架RH          UPPER STEP FRONT BRACKET RH          81615110024 RH          TG-X E6D 2020on</p> 	<p><b>ZC-M14-087</b>          下脚踏板后支架RH          UPPER STEP REAR BRACKET RH          81615110025 RH          TG-X E6D 2020on</p> 
<p><b>ZC-M14-088</b>          下脚踏板盖板          UPPER STEP COVER          81615206004 81615200115          TG-X E6D 2020on</p> 	<p><b>ZC-M14-089</b>          前叶子板后段LH          FRONT FENDER POSTERIOR SEGMENT LH          81612100911 LH 81612100913          81612100915 81612100917          81612100897          TG-X E6D 2020on</p> 	<p><b>ZC-M14-090</b>          前叶子板后段RH          FRONT FENDER POSTERIOR SEGMENT RH          81612100912 RH 81612100914          81612100916 81612100918          81612100898          TG-X E6D 2020on</p> 



FOR MAN

TG-X E6D 2020 ON



<p><b>ZC-M14-091</b> 前轮后挡泥板LH FRONT WHEEL REAR FENDER LH 81612100905 LH 81612110311 TG-X E6D 2020on</p> 	<p><b>ZC-M14-092</b> 前轮后挡泥板RH FRONT WHEEL REAR FENDER RH 81612100906 RH 81612110312 TG-X E6D 2020on</p> 	<p><b>ZC-M14-093</b> 前轮后泥板测板LH FRONT WHEEL REAR MUD PLATE MEASURING PLATE 81612100873 LH 81612100875 81612100889 81612100891 TG-X E6D 2020on</p> 
<p><b>ZC-M14-094</b> 前轮后泥板测板RH FRONT WHEEL REAR MUD PLATE MEASURING PLATE 81612100874RH 81612100876 81612100890 81612100892 TG-X E6D 2020on</p> 	<p><b>ZC-M14-095</b> 前轮后泥板测板LH FRONT WHEEL REAR MUD PLATE MEASURING PLATE LH 81612100897 LH TG-X E6D 2020on</p> 	<p><b>ZC-M14-096</b> 前轮后泥板测板RH FRONT WHEEL REAR MUD PLATE MEASURING PLATE RH 81612100898 RH TG-X E6D 2020on</p> 
<p><b>ZC-M14-097</b> 倒车镜总成LH MIRROR ASSEMBLY 81637306875 LH TG-X E6D 2020on</p> 	<p><b>ZC-M14-098</b> 倒车镜后盖LH MIRROR REAR COVER LH 81637320109 LH TG-X E6D 2020on</p> 	<p><b>ZC-M14-099</b> 倒车镜上盖 LH MIRROR UPPER COVER LH 81637320115 LH TG-X E6D 2020on</p> 
<p><b>ZC-M14-100</b> 倒车镜下盖LH MIRROR LOW COVER LH 81637320113 LH TG-X E6D 2020on</p> 	<p><b>ZC-M14-101</b> 倒车镜总成RH MIRROR ASSEMBLY RH 81637306874 RH TG-X E6D 2020on</p> 	<p><b>ZC-M14-102</b> 倒车镜后盖RH MIRROR REAR COVER RH 81637320108 RH TG-X E6D 2020on</p> 
<p><b>ZC-M14-103</b> 倒车镜上盖RH MIRROR UPPER COVER RH 81637320114 RH TG-X E6D 2020on</p> 	<p><b>ZC-M14-104</b> 倒车镜下盖RH MIRROR LOW COVER RH TG-X E6D 2020on</p> 	<p><b>ZC-M14-105</b> 倒车镜上大镜片LH MIRROR UPPER BIG CLASS LH 81637336083 LH TG-X E6D 2020on</p> 



<p><b>ZC-M14-106</b>                  倒车镜下大镜片LH                  MIRROR LOW BIG CLASS LH                  81637336085 LH                  TG-X E6D 2020on</p> 	<p><b>ZC-M14-107</b>                  倒车镜上大镜片RH                  MIRROR UPPER BIG CLASS RH                  81637336084 RH                  TG-X E6D 2020on</p> 	<p><b>ZC-M14-108</b>                  倒车镜下大镜片RH                  MIRROR LOW BIG CLASS RH                  81637336086 RH                  TG-X E6D 2020on</p> 
<p><b>ZC-M14-109</b>                  车门外拉手                  OUTSIDE DOOR HANDLE LH                  81626416119                  81626415013 LH                  TG-X E6D 2020on</p> 	<p><b>ZC-M14-110</b>                  车门外拉手                  OUTSIDE DOOR HANDLE RH                  81626416120 81626415014RH                  TG-X E6D 2020on</p> 	<p><b>ZC-M14-111</b>                  发动线束                  ENGINE WIRING HARNESS                  51254136448                  TG-X E6D 2020on</p> 



FOR MAN

# TG-X EURO6 14 ON



## ZC-M01-001

面板  
PANEL  
81611106095 81611106081  
TG-X 14 on



## ZC-M01-002

散热器隔栅挡板  
RADIATOR GRILLE  
81611500147 81611500172  
TG-X 14 on



## ZC-M01-003

散热器隔栅挡板  
RADIATOR GRILLE  
81611500138  
TG-X 14 on



## ZC-M01-004

面板铰链RH  
PANEL HINGE RH  
81611456004  
TG-X 14 on



## ZC-M01-005

面板铰链LH  
PANEL HINGE LH  
81611456005  
TG-X 14 on



## ZC-M01-006

面板合叶  
PANEL HIAGE  
81611456003 81611450004  
TG-X 14 on



## ZC-M01-007

面板中网  
GRILLE  
81611506094 81611500146  
81611500143  
TG-X 14 on



## ZC-M01-008

中网亮条  
GRILLE STRIP  
81611500141  
TG-X 14 on



## ZC-M01-009

外包角LH  
RANEL CORNER LH  
81611100089  
TG-X 14 on



## ZC-M01-010

外包角RH  
RANEL CORNER RH  
81611100088  
TG-X 14 on



## ZC-M01-011

内包角LH  
RANEL CORNER LH  
81611100091 81611100123  
TG-X 14 on



## ZC-M01-012

内包角RH  
RANEL CORNER RH  
81611100090 81611100122  
TG-X 14 on



## ZC-M01-013

大灯框LH  
HEAD LAMP CASE LH  
81416106751  
TG-X 14 on



## ZC-M01-014

大灯框RH  
HEAD LAMP CASE RH  
81416106750  
TG-X 14 on

















## ZC-M01-015

大灯框带喷嘴LH  
HEAD LAMP CASE LH  
81416106753  
TG-X 14 on



# FOR MAN TG-X EURO6 14 ON

















<p><b>ZC-M01-016</b>            大灯框带喷嘴RH            HEAD LAMP CASE RH            81416106752            TG-X 14 on</p> 	<p><b>ZC-M01-017</b>            大灯清洗盖 LH            HEAD LAMP CLEANING COVER LH            81416100533            TG-X 14 on</p> 	<p><b>ZC-M01-018</b>            大灯清洗盖 RH            HEAD LAMP CLEANING COVER RH            81416100532            TG-X 14 on</p> 
<p><b>ZC-M01-019</b>            大灯清洗盖翻转支架LH            OVERTURNED SUPPORT LH            81416100744            TG-X 14 on</p> 	<p><b>ZC-M01-020</b>            大灯清洗盖翻转支架RH            OVERTURNED SUPPORT RH            81416100575            TG-X 14 on</p> 	<p><b>ZC-M01-021</b>            大灯清洗翻盖弹簧            SPRING FOR SUPPORT            81976300196            TG-X 14 on</p> 
<p><b>ZC-M01-022</b>            大灯底座LH            HEAD LAMP BASE LH            81416106759 81416106969            TG-X 14 on</p> 	<p><b>ZC-M01-023</b>            大灯底座RH            HEAD LAMP BASE RH            81416106760 81416106968            TG-X 14 on</p> 	<p><b>ZC-M01-024</b>            雾灯框RH            FOG LAMP CASE RH            81416106754 RH            TG-X 14 on</p> 
<p><b>ZC-M01-025</b>            雾灯框LH            FOG LAMP CASE LH            81416106755            TG-X 14 on</p> 	<p><b>ZC-M01-026</b>            雾灯框 RH            FOG LAMP CASE RH            81416106758            TG-X 14 on</p> 	<p><b>ZC-M01-027</b>            雾灯框LH            FOG LAMP CASE LH            81416106757            TG-X 14 on</p> 
<p><b>ZC-M01-028</b>            大灯框卡子            HEAD LAMP HOUSING CLIP            81416100576            TG-X 14 on</p> 	<p><b>ZC-M01-029</b>            闭锁螺栓            LOCKING BOLT            81611446002            TG-X 14 on</p> 	<p><b>ZC-M01-030</b>            保险杠            BUMPER            81416106863            TG-X 14 on</p> 

FOR MAN

# TG-X EURO6 14 ON



<p><b>ZC-M01-031</b> 保险杠中段 泡沫内衬 BUMPER FOAM INSERT 8112636 TG-X 14 on</p> 	<p><b>ZC-M01-032</b> 保险杠中段饰盖RH BUMPER COVER RH 81416100558 TG-X 14 on</p> 	<p><b>ZC-M01-033</b> 保险杠中段饰盖LH BUMPER COVER LH 81416100559 TG-X 14 on</p> 
<p><b>ZC-M01-034</b> 保险杠中段踏板 BUMPER STEP MIDDLE 81416146009 TG-X 14 on</p> 	<p><b>ZC-M01-035</b> 保险杠中段下饰板 BUMPER GARNISH 81416140076 TG-X 14 on</p> 	<p><b>ZC-M01-036</b> 保险杠导向件RH BUMPER GUIDE RH 81416140074 TG-X 14 on</p> 
<p><b>ZC-M01-037</b> 保险杠导向件LH BUMPER GUIDE LH 81416140075 TG-X 14 on</p> 	<p><b>ZC-M01-038</b> 回线/环490mm LOOP/RING(490mm) 8196805006 TGX/TGS</p> 	<p><b>ZC-M01-039</b> 立柱盖板 LH PILLAR GARNISH COVER LH 81624100201 TG-X14 on/TG-S 14 on</p> 
<p><b>ZC-M01-040</b> 立柱盖板RH PILLAR GARNISH COVER RH 81624100202 TG-X14 on/TG-S 14 on</p> 	<p><b>ZC-M01-041</b> 玻璃升降器 LH WINDOWS REGULATOR LH 81626456039 81626456055 TG-X14 on/TG-S 14 on</p> 	<p><b>ZC-M01-042</b> 玻璃升降器RH WINDOWS REGULATOR RH 81626456040 81626456054 TG-X14 on/TG-S 14 on</p> 
<p><b>ZC-M01-043</b> 车门控制模块LH DOOR CONTROL MODULE LH 81258067109 81258067093 81258067092 TG-X14 on/TG-S 14 on</p> 	<p><b>ZC-M01-044</b> 车门控制模块RH DOOR CONTROL MODULE RH 81258067095 TG-X14 on/TG-S 14 on</p> 	<p><b>ZC-M01-045</b> 大灯支架LH HEAD LAMP BRACKET LH 81416100443 TG-X14 on/TG-S 14 on</p> 

FOR MAN

# TG-X EURO6 14 ON



## ZC-M01-046

大灯支架RH  
HEAD LAMP BRACKET RH  
81416100444  
TG-X14 on/TG-S 14 on



## ZC-M01-047

遮阳罩灯  
SUNVISOR LAMP  
81252606121  
TG-X14 on/TG-S 14 on



## ZC-M01-048

字牌  
MARK  
81978402108 81978402109  
81978402110 81978702045  
TG-X 14 on



## ZC-M01-049

OE6后灯 LH  
TG-X14 on/TG-S 14 on  
81252256563  
81252256565



## ZC-M01-050

OE6后灯 RH  
TG-X14 on/TG-S 14 on  
81252256562  
81252256566



## ZC-M01-051

雨刮支架  
WIPER BRACKET  
EURO6 TGX  
81611100096



## ZC-M01-052

进气接管  
INTAKE CONNECTOR  
EURO6 TGX/TGS  
81082016097



## ZC-M01-053

电瓶箱盖  
BATTERY COVER  
81418606110 81418600196  
81418600179



## ZC-M01-054

油底壳总成  
ENGINE OIL SUMP  
51058413019 TGXEU-  
RO6D26 76  
EURO6 TGX



## ZC-M01-055

油底壳总成  
ENGINE OIL SUMP  
51058015546 51058015557  
51058015578 51058015643  
51058015731 51058015755  
D0834 D0834LOH D0824  
D0824LOH



## ZC-M01-056

付水箱  
COOLANT EXPANSION TANK  
81061026232 81061026230  
81061025028  
EURO6 TGX/TGS



## ZC-M01-057

付水箱传感器  
CABLE HARNESS  
51254116022  
EURO6 TGX



## ZC-M01-058

付水箱盖  
FUEL TANK COVER  
81061110029  
EURO6 TGX



## ZC-M01-059

付水箱盖  
FUEL TANK COVER  
81061116007  
EURO6 TGX



## ZC-M01-060

付水箱盖  
FUEL TANK COVER  
81061110026  
EURO6 TGX



**FOR MAN**

**TG-X EURO6 14 ON**



**ZC-M01-061**

风扇罩  
FAN COVER  
81066200203  
EURO6 TGX



**ZC-M01-062**

TGX雾灯装饰亮条LH  
CHROME STRIP  
EURO6 TGX



**ZC-M01-063**

TGX雾灯装饰亮条RH  
CHROME STRIP  
EURO6 TGX



**ZC-M01-064**

保险杠BASIS中段上TGX  
PLASTIC BUMPER MIDDLE SECTION  
81416106951  
EURO6 TGX2016



**ZC-M01-065**

保险杠CHROM中段上TGX镀铬  
PLASTIC BUMPER MIDDLE SECTION  
CHROME  
81416106952  
EURO6 TGX2016



**ZC-M01-066**

保险杠中段饰盖LH  
COVER  
81416100713  
EURO6 TGX2016



**ZC-M01-067**

保险杠中段饰盖RH  
COVER  
81416100714  
EURO6 TGX2016



**ZC-M01-068**

保险杠中段踏板  
BUMPER STEP MIDDLE  
81416146011  
TGX 2016



**ZC-M01-069**

面板拉手LH  
HANDEL  
81611410003  
EURO6 TGX TGS



**ZC-M01-070**

面板拉手RH  
HANDEL  
81611410002  
EURO6 TGX TGS



**ZC-M01-071**

保险杠导向RH  
BUMPER GUIDE RH  
81416140086



**ZC-M01-072**

保险杠导向件LH  
BUMPER GUIDE LH  
81416140085



**ZC-M01-073**

保险杠中段下饰板  
BUMPER GARNISH  
81416140081



**ZC-M01-074**

中网标  
MARK  
81978702045



**ZC-M01-075**









保险杠防虫网  
BUMPER INSECT-PROOF NET



**FOR MAN**

# TG-X EURO6 14 ON



<p><b>ZC-M01-076</b> 大灯框LH HEAD LAMP CASE LH 81416106751 TG-X 14 on</p> 	<p><b>ZC-M01-077</b> 大灯框RH HEAD LAMP CASE RH 81416106750 TG-X 14 on</p> 	<p><b>ZC-M01-078</b> 大灯框带喷嘴LH HEAD LAMP CASE LH 81416106753 TG-X 14 on</p> 
<p><b>ZC-M01-079</b> 大灯框带喷嘴RH HEAD LAMP CASE RH 81416106752 TG-X 14 on</p> 	<p><b>ZC-M01-080</b> 雾灯框RH FOG LAMP CASE RH 81416106754 RH TG-X 14 on</p> 	<p><b>ZC-M01-081</b> 雾灯框LH FOG LAMP CASE LH 81416106755 TG-X 14 on</p> 
<p><b>ZC-M01-082</b> 雾灯框 RH FOG LAMP CASE RH 81416106758 TG-X 14 on</p> 	<p><b>ZC-M01-083</b> 雾灯框LH FOG LAMP CASE LH 81416106757 TG-X 14 on</p> 	<p><b>ZC-M01-083</b> 射灯 SPOTLIGHT TG-X 14 ON</p> 
<p><b>ZC-M01-084</b> 保险杠射灯 BUMPER SPOTLIGHT TG-X 14 ON</p> 	<p><b>ZC-M01-085</b> 油底壳 OIL PAN 51058006406 TG-X 14 ON</p> 	



FOR MAN

# TG-S EURO6 14 ON



## ZC-M02-001

面板  
PANEL  
81611106096 81611106082  
TG-S 14 on



## ZC-M02-002

面板中网  
GRILLE  
81611506097 81611500142  
TG-S 14 on



## ZC-M02-003

中网亮条  
GRILLE STRIP  
81611500140  
TG-S 14 on



## ZC-M02-004

字母  
MARK  
81978402111 81978402112  
81978402113 81978702045  
TG-S 14 on



## ZC-M02-005

外包角 LH  
PANEL CORNER LH  
81611100089  
TG-S 14 on



## ZC-M02-006

外包角 RH  
PANEL CORNER RH  
81611100088  
TG-S 14 on



## ZC-M02-007

内包角 LH  
PANEL CORNER LH  
81611100091 81611100123  
TG-S 14 on



## ZC-M02-008

内包角 RH  
PANEL CORNER RH  
81611100090 81611100122  
TG-S 14 on



## ZC-M02-009

大灯框LH  
HEAD LAMP CASE LH  
81416106761  
TG-S 14 on



## ZC-M02-010

大灯框 RH  
HEAD LAMP CASE RH  
81416106762  
TG-S 14 on



## ZC-M02-011保

保险杠喷嘴LH  
BUMPER LH  
81416106763  
TG-S 14 on



## ZC-M02-012

保险杠喷嘴 RH  
BUMPER RH  
81416106764  
TG-S 14 on



## ZC-M02-013

大灯清洗盖 LH  
HEAD LAMP CLEANING COVER LH  
81416100533  
TG-S 14 on



## ZC-M02-014

大灯清洗盖RH  
HEAD LAMP CLEANING RH  
COVER  
81416100532  
TG-S 14 on



## ZC-M02-015

大灯清洗盖翻转支架 LH  
OVERTURNED SUPPORT LH  
81416100744  
TG-S 14 on



# FOR MAN TG-S EURO6 14 ON



### ZC-M02-016

大灯清洗盖翻转支架RH  
OVERTURNED SUPPORT RH  
81416100595  
TG-S 14 on



### ZC-M02-017

大灯清洗盖翻盖弹簧  
SPRING FOR SUPPORT  
81976300196  
TG-S 14 on



### ZC-M02-018

大灯底座LH  
HEAD LAMP BASE LH  
81416106759  
TG-S 14 on



### ZC-M02-019

大灯底座 RH  
HEAD LAMP BASE RH  
81416106760  
TG-S 14 on



### ZC-M02-020

雾灯框 RH  
FOG LAMP CASE RH  
81416106767 81416106765  
TG-S 14 on



### ZC-M02-021

雾灯框 LH  
FOG LAMP CASE LH  
81416106768 81416106766  
TG-S 14 on



### ZC-M02-022

雾灯框 RH  
FOG LAMP CASE RH  
81416106767 81416106765  
TG-S 14 on



### ZC-M02-023

雾灯框 LH  
FOG LAMP CASE LH  
81416106768 81416106766  
TG-S 14 on



### ZC-M02-024

大灯框卡子  
HEAD LAMP HOUSING CLIP  
81416100576  
TG-S 14 on



### ZC-M02-025

闭锁螺栓  
LOCKING BOLT  
81611446002  
TG-S 14 on



### ZC-M02-026

保险杠中总成(内衬/外框)  
BUMPER INSERT  
81416106769  
TG-S 14 on



### ZC-M02-027

保险杠中段饰盖RH  
BUMPER COVER RH  
81416100560  
TG-S 14 on



### ZC-M02-028

保险杠中段饰盖LH  
BUMPER COVER LH  
81416100561  
TG-S 14 on



### ZC-M02-029

脚踏板  
BUMPER STEP MIDDLE  
81416146010  
TG-S 14 on



### ZC-M02-030

保险杠中段下饰板  
BUMPER GARNISH  
81416140077  
TG-S 14 on



# FOR MAN

## TG-S EURO6 14 ON



<p><b>ZC-M02-031</b> 保险杠导向RH BUMPER GUIDE RH 81416130020 81416140078 TG-S 14 on</p> 	<p><b>ZC-M02-032</b> 保险杠导向件LH BUMPER GUIDE LH 814130021 81416140079 TG-S 14 on</p> 	<p><b>ZC-M02-033</b> 外A立柱 LH FRONT PILLAR GARNISH LH 81624100193 81624100197 TG-X14 on/TG-S 14 on</p> 
<p><b>ZC-M02-034</b> 外A立柱 RH FRONT PILLAR GARNISH RH 81624100194 81624100198 TG-X14 on/TG-S 14 on</p> 	<p><b>ZC-M02-035</b> 外A立柱 LH FRONT PILLAR GARNISH LH 81624100193 81624100197 TG-X14 on/TG-S 14 on</p> 	<p><b>ZC-M02-036</b> 外A立柱 LH FRONT PILLAR GARNISH RH 81624100194 81624100198 TG-X14 on/TG-S 14 on</p> 
<p><b>ZC-M02-037</b> 外A立柱 LH FRONT PILLAR GARNISH LH 81624100189 81624100191 TG-X14 on/TG-S 14 on</p> 	<p><b>ZC-M02-038</b> 外A立柱 RH FRONT PILLAR GARNISH RH 81624100190 81624100192 TG-X14 on/TG-S 14 on</p> 	<p><b>ZC-M02-039</b> 立柱泡沫 LH PILLAR FOAM LH 81624100207 TG-X14 on/TG-S 14 on</p> 
<p><b>ZC-M02-040</b> 立柱泡沫RH PILLAR FOAM RH 81624100206 TG-X14 on/TG-S 14 on</p> 	<p><b>ZC-M02-041</b> 面板盖板 PANEL COVER 81611106088 81611100092 81611106084 EURO6 TGS TGM TGL</p> 	<p><b>ZC-M02-042</b> TGS雾灯装饰亮条LH CHROME STRIP EURO6 TGS</p> 
<p><b>ZC-M02-043</b> TGS雾灯装饰亮条RH CHROME STRIP EURO6 TGS</p> 	<p><b>ZC-M02-044</b> 保险杠BASIS中段上TGS喷漆 PLASTIC BUMPER MIDDLE SECTION 81416106956 EURO6 TGS 2016</p> 	<p><b>ZC-M02-045</b> 保险杠CHROM中段上TGS镀铬 PLASTIC BUMPER MIDDLE SECTION CHROME EURO6 TGS 2016</p> 

FOR MAN

# TG-S EURO6 14 ON



**ZC-M02-046**

保险杠中段饰盖LH  
COVER  
81416100715  
EURO6 TGS 2016



**ZC-M02-047**

保险杠中段饰盖RH  
COVER  
81416100716  
EURO6 TGS 2016



**ZC-M02-048**

保险杠中段踏板  
BUMPER STEP MIDDLE  
81416146012  
EURO6 TGS 2016



**ZC-M02-049**

防雾灯固定支架LH  
BRACKET  
81416100445  
MAN TGX OE6



**ZC-M02-050**

防雾灯固定支架LH  
BRACKET  
81416100446  
MAN TGX OE6



**ZC-M02-051**

保险杠导向RH  
BUMPER GUIDE RH  
81416140088

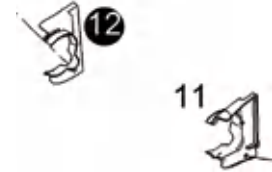

**ZC-M02-052**

保险杠导向件LH  
BUMPER GUIDE LH  
814161



**ZC-M02-053**

保险杠中段下饰板  
BUMPER GARNISH  
81416140081



**ZC-M02-054**

面板锁  
PANEL LOCK  
81971220042



**ZC-M02-055**

保险杠防虫网  
BUMPER INSECT-PROOF NET



**ZC-M02-056**

大灯框LH  
HEAD LAMP CASE LH  
81416106761  
TG-S 14 on



**ZC-M02-057**

大灯框 RH  
HEAD LAMP CASE RH  
81416106762  
TG-S 14 on



**ZC-M02-0158**

保险杠带喷嘴LH  
BUMPER LH  
81416106763  
TG-S 14 on



**ZC-M02-059**

保险杠带喷嘴 RH  
BUMPER RH  
81416106764  
TG-S 14 on



**ZC-M02-060**

雾灯框 RH  
FOG LAMP CASE RH  
81416106767 81416106765  
TG-S 14 on



FOR MAN

# TG-S EURO6 14 ON



## ZC-M02-061

雾灯框 LH  
FOG LAMP CASE LH  
81416106768 81416106766  
TG-S 14 on



## ZC-M02-062

雾灯框 RH  
FOG LAMP CASE RH  
81416106767 81416106765  
TG-S 14 on



## ZC-M02-063

雾灯框 LH  
FOG LAMP CASE LH  
81416106768 81416106766  
TG-S 14 on



## ZC-M02-064

反转支架(铁)  
BRACKET  
TG-S 14 ON



## ZC-M02-065

后灯LH  
TAIL LAMP LH  
81252256565  
TG-S 14 on



## ZC-M02-066后

灯RH  
TAIL LAMP RH  
81252256568  
TG-S 14 on



## ZC-M02-067

后灯罩  
TAIL LAMP CASE  
81252300031  
TG-S 14 ON



## ZC-M02-068空

滤桶  
81084050037  
81084050036  
81084006107  
TG-S 14 ON



## ZC-M02-069

面板锁RH  
PANEL LOCK RH  
81.97116-6080  
81.97116-6078 RH  
TG-S 14 ON



## ZC-M02-070

面板锁 LH  
PANEL LOCK LH  
]81.97116-6081  
81.97116-6077 LH  
TG-S 14 ON



## ZC-M02-071

车门下护板RH  
DOOR PANEL RH  
81626100020 81626100032



## ZC-M02-072















车门下护板LH  
DOOR PANEL LH  
81626100021 81626100033



FOR MAN

TG-S EURO6 TRACTORS 14 ON

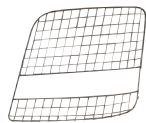
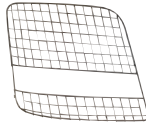















<p><b>ZC-M02R-001</b>            大灯框LH            HEAD LAMP CASE LH            81416100423            TG-S TRACTORS 14</p> 	<p><b>ZC-M02R-002</b>            大灯框RH            HEAD LAMP CASE RH            81416100424            TG-S TRACTORS 14</p> 	<p><b>ZC-M02R-003</b>            大灯框LH            HEAD LAMP CASE LH            81416106631            TG-S TRACTORS 14</p> 
<p><b>ZC-M02R-004</b>            大灯框RH            HEAD LAMP CASE RH            81416106630            TG-S TRACTORS 14</p> 	<p><b>ZC-M02R-005</b>            大灯支架LH            HEAD LAMP BRACKET LH            81416105685            TG-S TRACTORS 14</p> 	<p><b>ZC-M02R-006</b>            大灯支架RH            HEAD LAMP BRACKET RH            81416105684            TG-S TRACTORS 14</p> 
<p><b>ZC-M02R-007</b>            大灯支架LH            HEAD LAMP BRACKET LH            81416100441            TG-S TRACTORS 14</p> 	<p><b>ZC-M02R-008</b>            大灯支架RH            HEAD LAMP BRACKET RH            81416100442            TG-S TRACTORS 14</p> 	<p><b>ZC-M02R-009</b>            保险杠支架LH            BUMPER BRACKET LH            81416100447            81416100493            81416100491            TG-S TRACTORS 14</p> 
<p><b>ZC-M02R-010</b>            保险杠支架RH            BUMPER BRACKET RH            81416100448            81416100492            81416100494            TG-S TRACTORS 14</p> 	<p><b>ZC-M02R-011</b>            杠边条 LH            BUMPER BRACKET LH            81416100435            TG-S TRACTORS 14</p> 	<p><b>ZC-M02R-012</b>            杠边条 RH            BUMPER BRACKET RH            81416100436            TG-S TRACTORS 14</p> 
<p><b>ZC-M02R-013</b>            大灯护框 LH            HEAD LAMP PROTECTOR CASE LH            81416305057            TG-S TRACTORS 14</p> 	<p><b>ZC-M02R-014</b>            大灯护框 RH            HEAD LAMP PROTECTOR CASE RH            81416305056            TG-S TRACTORS 14</p> 	<p><b>ZC-M02R-015</b>            脚踏板组装            PEDAL ASSEMBLY            81416106627            TG-S TRACTORS 14</p> 



FOR MAN

TG-S EURO6 TRACTORS 14 ON



<p><b>ZC-M02R-016</b>          保险杠中段          BUMPER MIDDLE          81412800069          TG-S TRACTORS 14</p> 	<p><b>ZC-M02R-017</b>          保险杠中段          BUMPER MIDDLE          TG-S TRACTORS 14</p> 	<p><b>ZC-M02R-018-L</b>          杠防滑条 LH          BUMPER STEP LH          81416140071          TG-S TRACTORS 14</p> 
<p><b>ZC-M02R-018-R</b>          杠防滑条 RH          BUMPER STEP RH          81416140070          TG-S TRACTORS 14</p> 	<p><b>ZC-M02R-019</b>          雾灯盖板LH          FOG LAMP COVER LH          81416100465          TG-S TRACTORS 14</p> 	<p><b>ZC-M02R-020</b>          雾灯盖板RH          FOG LAMP COVER RH          81416100460          TG-S TRACTORS 14</p> 
<p><b>ZC-M02R-021</b>          前照灯防护栅网OE6 LH          GRILLE          81416305051          TGX/TGS</p> 	<p><b>ZC-M02R-022</b>          前照灯防护栅网OE6 RH          GRILLE          81416305050          TGX/TGS</p> 	<p><b>ZC-M02R-023</b>          大灯护框卡扣          HEADLAMP GUARD FRAME CLASP          81416300010          EURO6 TGS</p> 
<p><b>ZC-M02R-024</b>          大灯护框卡扣          HEADLAMP GUARD FRAME CLASP          81416300011          EURO6 TGS</p> 	<p><b>ZC-M02R-025</b>          大灯框LH          HEAD LAMP COVER          81416105729 81416100487          TG-X 14 ON</p> 	<p><b>ZC-M02R-026</b>          大灯框RH          HEAD LAMP COVER          81416105730 81416100488          TG-X 14 ON</p> 
<p><b>ZC-M02R-027</b>          杠灯边条LH/RH          SIDE LAMP MOULDING          81416100703 81416100699 LH          81416100704 81416100700RH          TG-X 14 ON</p> 	<p><b>ZC-M02R-028</b>          保险杠支架LH          BUMPER BRACKET LH          81416100499          81416100695          TG-S TRACTORS 14</p> 	<p><b>ZC-M02R-029</b>          保险杠支架RH          BUMPER BRACKET RH          81416100500          81416100696          TG-S TRACTORS 14</p> 

# FOR MAN TG-M EURO6 14 ON



<p><b>ZC-M03-001</b>            面板            PANEL            81611100104            TG-M 14 on</p> 	<p><b>ZC-M03-002</b>            面板中网            GRILLE            81611500145            TG-M 14 on</p> 	<p><b>ZC-M03-003</b>            中网亮条            GRILLE STRIP            81611500140            TG-M 14 on</p> 
<p><b>ZC-M03-004</b>            字牌            MARK            81978402086 81978402087            81978402088 81978702045            TG-M 14 on</p> 	<p><b>ZC-M03-005</b>            外包角 LH            PANEL CORNER LH            81611100100            TG-M 14 on</p> 	<p><b>ZC-M03-006</b>            外包角 RH            PANEL CORNER RH            81611100101            TG-M 14 on</p> 
<p><b>ZC-M03-007</b>            内包角 LH            PANEL CORNER LH            81611100098            81611100124            TG-M 14 on</p> 	<p><b>ZC-M03-008</b>            内包角 RH            PANEL CORNER RH            81611100099            81611100125            TG-M 14 on</p> 	<p><b>ZC-M03-009</b>            大灯框LH            HEAD LAMP CASE LH            81416105695            81416105711            81416105711            TG-M 14 on</p> 
<p><b>ZC-M03-010</b>            大灯框 RH            HEAD LAMP CASE RH            81416105696            81416105718            81416105716            TG-M 14 on</p> 	<p><b>ZC-M03-011</b>            大灯框 LH            HEAD LAMP CASE LH            81416105695            TG-M 14 on</p> 	<p><b>ZC-M03-012</b>            大灯框 RH            HEAD LAMP CASE RH            81416105696            TG-M 14 on</p> 
<p><b>ZC-M03-013</b>            保险杠中段内骨架            BUMPER BRACKET            81416105742 81416105705            81416105695            TG-M 14 on</p> 	<p><b>ZC-M03-014</b>            保险杠中段            BUMPER MIDDLE            81416106685            TG-M 14 on</p> 	<p><b>ZC-M03-015</b>            大灯内框总成LH            HEAD LAMP HOUSING LH            81416105727 81416105699            TG-M 14 on</p> 

FOR MAN

# TG-M EURO6 14 ON



**ZC-M03-016**

大灯内框总成 RH  
HEAD LAMP HOUSING RH  
81416105728 81416105700  
TG-M 14 on



**ZC-M03-017**

大灯清洗盖 LH  
HEAD LAMP CLEANING COVER LH  
81416100562 81416100472  
TG-M 14 on



**ZC-M03-018**

大灯清洗盖 RH  
HEAD LAMP CLEANING COVER RH  
81416100563 81416100471  
TG-M 14 on



**ZC-M03-019**

牌照板  
LICENCE PLATE  
81416106657  
TG-M 14 on



**ZC-M03-020**

脚踏板饰板  
STEP GARNISH  
81416106807  
TG-M 14 on



# FOR MAN TG-L EURO6 14 ON



<p><b>ZC-M04-001</b>                      面板                      PANEL                      81611106104                      TG-L 14 on</p> 	<p><b>ZC-M04-002</b>                      面板中网                      GRILLE                      81611500145                      TG-L 14 on</p> 	<p><b>ZC-M04-003</b>                      中网亮条                      GRILLE STRIP                      81611500140                      TG-L 14 on</p> 
<p><b>ZC-M04-004</b>                      字牌                      MARK                      81978402086 81978402087                      81978402088 81978702045                      TG-L 14 on</p> 	<p><b>ZC-M04-005</b>                      外包角 LH                      PANEL CORNER LH                      81611100100                      TG-L 14 on</p> 	<p><b>ZC-M04-006</b>                      外包角 RH                      PANEL CORNER RH                      81611100101                      TG-L 14 on</p> 
<p><b>ZC-M04-007</b>                      内包角 LH                      PANEL CORNER LH                      81611100098                      81611100124                      TG-L 14 on</p> 	<p><b>ZC-M04-008</b>                      内包角 RH                      PANEL CORNER RH                      81611100099                      81611100125                      TG-L 14 on</p> 	<p><b>ZC-M04-009</b>                      大灯框 LH                      HEAD LAMP CASE LH                      81416106855                      TG-L 14 on</p> 
<p><b>ZC-M04-010</b>                      大灯框RH                      HEAD LAMP CASE RH                      81416106854                      TG-L 14 on</p> 	<p><b>ZC-M04-011</b>                      保险杠中段内骨架                      BUMPER                      81416105741                      81416105701                      TG-L 14 on</p> 	<p><b>ZC-M04-012</b>                      保险杠中段                      BUMPER MIDDLE                      81416106684                      TG-L 14 on</p> 
<p><b>ZC-M04-013</b>                      牌照板                      LICENCE PLATE                      81429400304                      TG-L 14 on</p> 	<p><b>ZC-M04-014</b>                      脚踏板饰板                      STEP GARNISH                      81416106806                      TG-L 14 on</p> 	<p><b>ZC-M04-015</b>                      大灯内框总成LH                      HEAD LAMP HOUSING LH                      81416105727 81416105699                      TG-M 14 on</p> 

FOR MAN

# TG-L EURO6 14 ON



## ZC-M04-016

大灯内框总成 RH  
HEAD LAMP HOUSING RH  
81416105728 81416105700  
TG-M 14 on



## ZC-M04-017

大灯框LH  
HEAD LAMP COVER  
81416105729  
TG-M 14 on



## ZC-M04-018

大灯框RH  
HEAD LAMP COVER  
81416105730  
TG-M 14 on



## ZC-M04-019

杠踏板  
BUMPER PADEL  
81416100463  
TG-M 14 on



## ZC-M04-020

遮阳罩(203\*29cm)  
SUNCISOR  
81637010055 81637010058  
TG-M 14 on



## ZC-M04-021

雨刮连杆(790 CM)  
LINKAGE  
81264116111



## ZC-M04-022

挡泥板内衬RH  
MUDGUARD INNER RH  
81612300260  
81612300218



102CM

## ZC-M04-023

挡泥板内衬LH  
MUDGUARD INNER LH  
81612300261  
81612300217



102CM















## ZC-M04-024

机油盖  
OIL FILLER CAP  
51055050010



# FOR MAN TG-X



<p><b>ZC-M05-001</b>            面板PANEL            81611106041 81611106038 81611100065            TG-X XL, XLX &amp; XXL</p> <p>237CM</p>  <p>90.5CM</p>	<p><b>ZC-M05-002</b>            外包角RH            PANEL CORNER RH            81611100068            TG-X XL, XLX &amp; XXL</p> 	<p><b>ZC-M05-003</b>            外包角LH            PANEL CORNER LH            81611100067            TG-X XL, XLX &amp; XXL</p> 
<p><b>ZC-M05-004</b>            内包角RH            BUMPER INNER CORNER RH            81611106032 81611106048            TG-X XL, XLX &amp; XXL</p> 	<p><b>ZC-M05-005</b>            内包角LH            BUMPER INNER CORNER LH            81611106033 81611106049            TG-X XL, XLX &amp; XXL</p> 	<p><b>ZC-M05-006</b>            面板中网亮条            GRILLE STRIP            81611500124            TG-X XL, XLX &amp; XXL</p> 
<p><b>ZC-M05-007</b>            护罩 FRONT GRILLE            81611506058 81871506065            TG-X XL, XLX &amp; XXL</p>  <p>157.5CM</p> <p>47.5CM</p>	<p><b>ZC-M05-008</b>            字牌            MARK            81978402086 81978402102            81978402087 81978402103            81978402088 81978402104            81978702034 81978702038            TG-X XL, XLX &amp; XXL</p> 	<p><b>ZC-M05-009</b>            保险杠BUMPER            81416100363(P) 81416100364(G)            81416100402            TG-X XL, XLX &amp; XXL</p> <p>240CM</p>  <p>97CM</p>
<p><b>ZC-M05-010</b>            保险杠支架RH            BUMPER BRACKET RH            81416146004            TG-X XL, XLX &amp; XXL</p> 	<p><b>ZC-M05-011</b>            保险杠支架LH            BUMPER BRACKET LH            81416146003            TG-X XL, XLX &amp; XXL</p> 	<p><b>ZC-M05-012</b>            保险杠亮条            GRILLE SURROUND CHROME            81416144000            TG-X XL, XLX &amp; XXL</p> 
<p><b>ZC-M05-013</b>            杠边条RH            BUMPER BRACKET RH            81416100370            81416100372            TG-X XL, XLX &amp; XXL</p> 	<p><b>ZC-M05-014</b>            杠边条LH            BUMPER BRACKET LH            81416100369            81416100371            TG-X XL, XLX &amp; XXL</p> 	<p><b>ZC-M05-015</b>            保险杠弯角RH            BUMPER CORNER RH            81416140026            81416140030            TG-X XL, XLX &amp; XXL</p> 



# TG-X FOR MAN



<p><b>ZC-M05-016</b> 保险杠弯角LH BUMPER CORNER LH 81416140025 81416140029 TG-X XL, XLX &amp; XXL</p> 	<p><b>ZC-M05-017</b> 下台阶(ABS低位)RH STEP PANEL(ABS)(LOW) RH 81615100802 81615100798 81615100752 81615100748 81615100372 81615100374 81615100782 TG-X XL, XLX &amp; XXL</p> 	<p><b>ZC-M05-018</b> 下台阶(ABS低位)LH STEP PANEL(ABS)(LOW) LH 81615100801 81615100797 81615100751 81615100747 81615100373 81615100311 81615100781 TG-X XL, XLX &amp; XXL</p> 
<p><b>ZC-M05-019</b> 大灯RH HEAD LAMP RH 81251016496 81251016514 81251016498 81251016584 TG-X XL, XLX &amp; XXL</p> 	<p><b>ZC-M05-020</b> 大灯LH HEAD LAMP LH 81251016497 81251016513 81251016499 81251016585 TG-X XL, XLX &amp; XXL</p> 	<p><b>ZC-M05-021</b> 大灯盖板RH HEAD LAMP COVER RH 81251400138 TG-X XL, XLX &amp; XXL</p> 
<p><b>ZC-M05-022</b> 大灯盖板LH HEAD LAMP COVER LH 81251400139 TG-X XL, XLX &amp; XXL</p> 	<p><b>ZC-M05-023</b> 大灯玻璃RH HEAD LAMP GLASS RH 81251100084</p> 	<p><b>ZC-M05-024</b> 大灯玻璃LH HEAD LAMP GLASS LH 81251100083</p> 
<p><b>ZC-M05-025</b> 大灯盖板RH HEAD LAMP COVER RH 81416850136 TG-X XL, XLX &amp; XXL</p> 	<p><b>ZC-M05-026</b> 大灯盖板LH HEAD LAMP COVER LH 81416850135 TG-X XL, XLX &amp; XXL</p> 	<p><b>ZC-M05-027</b> 防雾灯RH FOG LAMP RH 81251016522 TG-X XL, XLX &amp; XXL</p> 
<p><b>ZC-M05-028</b> 防雾灯LH FOG LAMP LH 81251016521 TG-X XL, XLX &amp; XXL</p> 	<p><b>ZC-M05-029</b> 防雾灯玻璃RH FOG LAMP GLASS RH 81251100086 TG-X XL, XLX &amp; XXL</p> 	<p><b>ZC-M05-030</b> 防雾灯玻璃LH FOG LAMP GLASS LH 81251100085 TG-X XL, XLX &amp; XXL</p> 

# TG-X FOR MAN



### ZC-M05-031

后灯罩 RH  
TAIL LAMP LENS RH  
81252256060  
TG-X XL, XLX & XXL



### ZC-M05-032

后灯罩 LH  
TAIL LAMP LENS LH  
81252256059  
TG-X XL, XLX & XXL



### ZC-M05-033

后灯 RH  
REAR LAMP RH  
81252256540 81252256544  
81252256548 81252256550  
TG-X XL, XLX & XXL



### ZC-M05-034

后灯 LH  
REAR LAMP LH  
81252256541 81252256545  
81252256549 81252256551  
TG-X XL, XLX & XXL



### ZC-M05-035

遮阳罩 (221\*36cm)  
SUNCISOR  
81637010044 81637010033  
TG-X XL, XLX & XXL

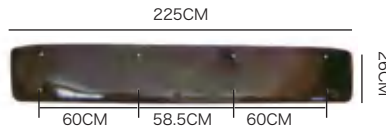

### ZC-M05-036

雾灯盖板 RH  
FOG LAMP COVER RH  
81416850096  
TG-X XL, XLX & XXL

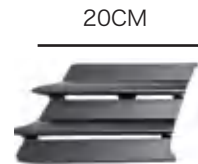

### ZC-M05-037

雾灯盖板 LH  
FOG LAMP COVER LH  
81416850097  
TG-X XL, XLX & XXL



### ZC-M05-038

雾灯盖板 RH  
FOG LAMP COVER RH  
81416850100 81416850098  
TG-X XL, XLX & XXL



### ZC-M05-039

雾灯盖板 LH  
FOG LAMP COVER LH  
81416850101 81416850099  
TG-X XL, XLX & XXL



### ZC-M05-040

面板盖板  
PANEL COVER  
81611400032



### ZC-M05-041

下台阶 (ABS低位) RH  
STEP PANEL (ABS) (LOW) RH  
81615100802 81615100798  
81615100752 81615100748  
81615100372 81615100374  
81615100782  
TG-X XL, XLX & XXL



### ZC-M05-042

下台阶 (ABS低位) LH  
STEP PANEL (ABS) (LOW) LH  
81615100801 81615100797  
81615100751 81615100747  
81615100333 81615100311  
81615100781  
TG-X XL, XLX & XXL



### ZC-M05-043

倒车镜 LH  
MIRROR LH  
81637306560  
TG-X XL, XLX & XXL



### ZC-M05-044

倒车镜 RH  
MIRROR RH  
81637306561  
TG-X XL, XLX & XXL



### ZC-M05-045

后视镜支架 LH  
MIRROR BRACKET LH  
81637316638  
TG-X XL, XLX & XXL



# TG-X FOR MAN



### ZC-M05-046

后视镜支架RH  
MIRROR BRACKET RH  
81637316639  
TG-X XL, XLX & XXL



### ZC-M05-047

倒车镜后盖RH  
MIRROR COVER RH  
81637310356  
TG-X XL, XLX & XXL



### ZC-M05-048

倒车镜后盖(电镀)LH  
MIRROR COVER ELECTRO PLATE LH  
81637310357  
TG-X XL, XLX & XXL



### ZC-M05-049

倒车镜上盖RH  
MIRROR COVER RH  
81637320074  
TG-X XL, XLX & XXL



### ZC-M05-050

倒车镜上盖LH  
MIRROR COVER LH  
81637320073  
TG-X XL, XLX & XXL



### ZC-M05-051

倒车镜下盖RH  
MIRROR COVER RH  
81637320076  
TG-X XL, XLX & XXL



### ZC-M05-052

倒车镜下盖LH  
MIRROR COVER LH  
81637320075  
TG-X XL, XLX & XXL



### ZC-M05-053

倒车镜大镜片  
MIRROR  
81637336071



### ZC-M05-054

倒车镜小镜片  
MIRROR  
81637336072



### ZC-M05-055

后视镜镜壳(内)  
MIRROR COVER (INNER)  
81637320091  
TG-X XL, XLX & XXL



### ZC-M05-056

遮阳罩灯  
SUNVISOR LAMP  
81252606121



### ZC-M05-057

保险杠小方盖LH  
BUMPER COVER LH  
81416850071  
81416850073  
TG-X XL, XLX & XXL



### ZC-M05-058

保险杠小方盖RH  
BUMPER COVER RH  
81416850072  
81416850074  
TG-X XL, XLX & XXL



### ZC-M05-059

保险杠小方盖LH  
BUMPER COVER LH  
81416850065  
81416850113  
TG-X XL, XLX & XXL

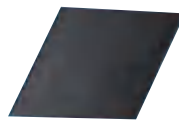





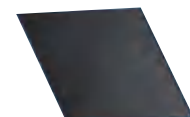









### ZC-M05-060

保险杠小方盖RH  
BUMPER COVER RH  
81416850114  
81416850112  
TG-X XL, XLX & XXL

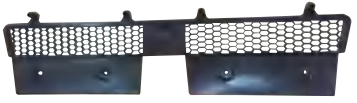



# TG-X FOR MAN



<p><b>ZC-M05-061</b> 车门铰链 DOOR HINGE 81971220028 81971220041 TG-X XL, XLX &amp; XXL</p> 	<p><b>ZC-M05-062</b> 车门铰链上 DOOR HINGE 81626906037 LH 81626906036 RH TG-X XL, XLX &amp; XXL</p> 	<p><b>ZC-M05-063</b> 车门铰下 DOOR HINGE 81626906055 LH 81626906063 LH 81626906056 RH 81626906064 RH TG-X XL, XLX &amp; XXL</p> 
<p><b>ZC-M05-064</b> 车门铰下 DOOR HINGE 81626906049 LH 81626906050 RH TG-X XL, XLX &amp; XXL</p> 	<p><b>ZC-M05-065</b> 方向锁 DIRECTIONAL LOCK 85464336002 TG-X XL, XLX &amp; XXL</p> 	<p><b>ZC-M05-066</b> 面板中网 PANEL GRILLE 81611500173 81611500136 TG-X XL, XLX &amp; XXL</p> 
<p><b>ZC-M05-067</b> 面板合叶 HINGE PANEL 81624400042 TG-X</p> 	<p><b>ZC-M05-068</b> 面板合叶 PANEL HINGE 81611450004 TG-X</p> 	<p><b>ZC-M05-069</b> 面板中网 PANEL GRILLE 81611500172 TG-X XL, XLX &amp; XXL</p> 
<p><b>ZC-M05-070</b> 闭锁螺栓 LOCKING BOLT 81611446002 TG-X XL, XLX &amp; XXL</p> 	<p><b>ZC-M05-071</b> 连接杆 JOINT LEVER 81611440023 TG-X XL, XLX &amp; XXL</p> 	<p><b>ZC-M05-072</b> 侧围外皮 LH SIDE ENCLOSURE LH 81625104604 TG-S TG-X XL, XLX &amp; XXL</p> 
<p><b>ZC-M05-073</b> 侧围外皮 RH SIDE ENCLOSURE RH 81625104608 TG-S TG-X XL, XLX &amp; XXL</p> 	<p><b>ZC-M05-074</b> 侧围内皮 LH INNER ENCLOSURE LH 81625304279 TG-X XL, XLX &amp; XXL</p> 	<p><b>ZC-M05-075</b> 侧围内皮 RH INNER ENCLOSURE RH 81625304283 TG-X XL, XLX &amp; XXL</p> 

# TG-X FOR MAN

















<p><b>ZC-M05-076</b>            轮胎内环箍LH            TYRE RING HOOP LH            81625302346            TG-X XL, XLX &amp; XXL</p> 	<p><b>ZC-M05-077</b>            轮胎内环箍RH            TYRE RING HOOP RH            81625302347            TG-X XL, XLX &amp; XXL</p> 	<p><b>ZC-M05-078</b>            门立柱LH            DOOR PILLER GARNISH LH            81625304367            TG-X XL, XLX &amp; XXL</p> 
<p><b>ZC-M05-079</b>            门立柱RH            DOOR PILLER GARNISH RH            81625304368            TG-X XL, XLX &amp; XXL</p> 	<p><b>ZC-M05-080</b>            前围            FRONT PANEL            81614304490            TG-X XL, XLX &amp; XXL</p> 	<p><b>ZC-M05-081</b>            工作台            WORKBENCH            81617016361            TGX</p> 
<p><b>ZC-M05-082</b>            喷油器线束            CYLINDER CONNECTER            51254136088            51254136104            TGX TGS TGA</p> 	<p><b>ZC-M05-083</b>            面板锁止楔组装            STRIKER PLATE FRONT PANEL            81611406008            TGX TGS</p> 	<p><b>ZC-M05-084</b>            面板锁            PANEL LOCK            81971160275            TGX TGS</p> 
<p><b>ZC-M05-085</b>            雨刮臂            WIPER ARM            81264306072 81264306070            TGX TGS TGA</p> 	<p><b>ZC-M05-086</b>            雨刮片            WIPER BLADE            81264406035 81264400063            TGX TGS TGA</p> 	<p><b>ZC-M05-087</b>            天窗护框带灯孔            ROOF COVER FRAME WITH            LIGHT HOLE            81629410090            TGX TGS TGA</p> 
<p><b>ZC-M05-088</b>            天窗电动            ROOF ELECTRICA            81629416065 81629416064            TGX TGS TGA</p> 	<p><b>ZC-M05-089</b>            天窗拉手            HANDLE ROOF            81629416055            TGX TGS TGA</p> 	<p><b>ZC-M05-090</b>            天窗护框不带灯孔            ROOF COVER FRAME W/O LIGHT HOLE            81629410090            TGX TGS TGA</p> 



# TG-X FOR MAN



<p><b>ZC-M05-091</b> 车门灯 DOOR LIGHT 81252036015 81252036001 TGX TGS TGA</p> 	<p><b>ZC-M05-092</b> 雨刮连杆长(980 CM) LINKAGE (PANE WIPER) 81264116112 MAN TGX</p> 	<p><b>ZC-M05-093</b> TGXTGS前大灯LED LED MODULE BREWKA PATTERN 81259080464 TGX/TGS</p> 
<p><b>ZC-M05-094</b> 稳定器支架后LH(61.5CM) STABILISER SUPPORT (61.5CM) 81437185115 MAN</p> <p>61.5CM</p> 	<p><b>ZC-M05-095</b> 稳定器支架后RH(61.5CM) STABILISER SUPPORT (61.5CM) 81437185116 MAN</p> <p>61.5CM</p> 	<p><b>ZC-M05-096</b> 稳定器支架前LH(65.3CM) STABILISER SUPPORT (65.3CM) 81437185113 MAN</p> <p>65.3CM</p> 
<p><b>ZC-M05-097</b> 稳定器支架前RH(65.3CM ) STABILISER SUPPORT (65.3CM) 81437185120 MAN</p> <p>65.3CM</p> 	<p><b>ZC-M05-098</b> 牵引联接器 TOWBAR 81420156008 81420156025 81420156026 81420156030 MAN</p> 	<p><b>ZC-M05-099</b> 防蝇网 PLASA INSECTE 81062016025 TGX</p> <p>69CM</p> <p>92CM</p> 
<p><b>ZC-M05-100</b> 摇窗机电机LH POWER WINDOW MOTOR 81286016137 81286016107 TGX/TGS</p> 	<p><b>ZC-M05-101</b> 摇窗机电机RH POWER WINDOW MOTOR 81286016138 81286016108 TGX/TGS</p> 	<p><b>ZC-M05-102</b> 车 门板小拉手LH HANDLE 81626415011 TGX/TGS</p> 
<p><b>ZC-M05-103</b> 车 门板小拉手RH HANDLE 81626415010 TGX/TGS</p> 	<p><b>ZC-M05-104</b> 车门内护板LH DOOR LINING 81626306105 81626306107 81626306117 TGX/TGS</p> 	<p><b>ZC-M05-105</b> 车门内护板RH DOOR LINING 81626306106 81626306108 81626306118 TGX/TGS</p> 





**ZC-M05-106**

横梁和支架后部  
BELLOWS HOLDER  
82436405072  
TGX/TGS



**ZC-M05-107**

大灯盖板卡子  
CLAMP  
81976400294  
TGX/TGS



**ZC-M05-108**

防雾灯固定支架  
BRACKET  
81416100531  
MAN TGX



**ZC-M05-109**

杠防滑条  
BAR ANTISKID BAR  
81416142184  
TGX/TGS



**ZC-M05-110**

遮阳罩(221.5\*37cm)  
SUNCISOR  
81637010062 81637010048



**ZC-M05-111**

遮阳罩(223.5\*28cm)  
SUNCISOR  
81637010057

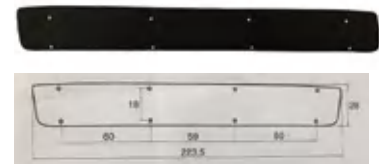

**ZC-M05-112**

侧面板RH  
SIDE PLATE RH  
81629100144  
TGX



**ZC-M05-113**

侧面板LH  
SIDE PLATE LH  
81629100145  
TGX



**ZC-M05-114**

空调鼓风机  
81619306101 81619306086  
TGX/TGS



**ZC-M05-115**

字牌  
MARK  
TGX/TGS



**ZC-M05-116**

雾灯孔盖(带雾灯)RH  
FOG LAMP COVER RH TGS  
81416850094



**ZC-M05-117**

雾灯孔盖(带雾灯)LH  
FOG LAMP COVER LH TGS  
81416850139



**ZC-M05-118**

保险杠防虫网  
BUMPER INSECT-PROOF NET



**ZC-M05-119**

杠弯角皮圈  
BAR BEND CORNER LEATHER RING  
81960010551













**ZC-M05-120**

面板中网  
PANEL MID-NET  
81611506076





<p><b>ZC-M05-121</b> 中网亮条 GRILEE STRIP 81611500155</p> 	<p><b>ZC-M05-122</b> 字牌 SUIT TILES 81978402120 81978402121 81978402122</p> 	<p><b>ZC-M05-123</b> 狮子字牌 LION CHARACTER81978702045</p> 
<p><b>ZC-M05-124</b> 中网卡子 CENTRAL NETWORK CARD 81971030012</p> 	<p><b>ZC-M05-125</b> 挡风玻璃 WINDSHIELD 81.62450.0071 BREDD (MM): 2254 HÖJD (MM): 880</p> 	<p><b>ZC-M05-126</b> 驾驶室后工作灯 CAB REAR WORKING LIGHT</p> 
<p><b>ZC-M05-127</b> 喷油嘴 INJECTOR NOZZLE 51101006032 51101006035 51101006048 51101006125</p> 	<p><b>ZC-M05-128</b> 喷油嘴 INJECTOR NOZZLE 51101006126 51101006126</p> 	<p><b>ZC-M05-129</b> 踏板皮 PEDAL LEATHER 81482270006</p> 
<p><b>ZC-M05-130</b> 增压发动机 TURBOCHARGED ENGINE 81619300055</p> 	<p><b>ZC-M05-131</b> 轴承支座右边 CABIN SUSPENSION BRACKET RH 81417202782 MAN</p> 	<p><b>ZC-M05-132</b> 轴承支座左边 CABIN SUSPENSION BRACKET LH 81417202783 MAN</p> 
<p><b>ZC-M05-133</b> 空调壳底盖 COVER AIR FILTER 8161942-0084</p> 	<p><b>ZC-M05-134</b> 空调壳底座 COVER AIR FILTER 81619100028</p> 	<p><b>ZC-M05-135</b> 油箱盖 FUEL TANK COVER 81122106027</p> 

# TG-S FOR MAN



<p><b>ZC-M06-001</b>            面板PANEL            81611106042 81611100066            81611106039 81611100075            81611106043 81611106040            TG-S M,L&amp;LX</p> <p>218CM</p> 	<p><b>ZC-M06-002</b>            外包角RH            PANEL CORNER RH            81611100068            TG-S M,L&amp;LX</p> 	<p><b>ZC-M06-003</b>            外包角LH            PANEL CORNER LH            81611100067            TG-S M,L&amp;LX</p> 
<p><b>ZC-M06-004</b>            内包角RH            BUMPER INNER CORNER RH            81611106032 81611106048            TG-S M,L&amp;LX</p> 	<p><b>ZC-M06-005</b>            内包角LH            BUMPER INNER CORNER LH            81611106033 81611106049            TG-S M,L&amp;LX</p> 	<p><b>ZC-M06-006</b>            面板中网亮条            GRILLE STRIP            81611500125            TG-S M,L&amp;LX</p> 
<p><b>ZC-M06-007</b>            护罩 FRONT GRILLE            81611506059 81871506066            TG-S M,L&amp;LX</p> 	<p><b>ZC-M06-008</b>            字牌            MARK            81978402086 81978402102            81978402087 81978402103            81978402088 81978402104            81978702034 81978702038            TG-S M,L&amp;LX</p> 	<p><b>ZC-M06-009</b>            保险杠BUMPER            81416100361 81416100362            81416100397            TG-S M,L&amp;LX</p> <p>225.5CM</p> 
<p><b>ZC-M06-010</b>            大灯盖板RH            HEAD LMAP CASE RH            81416850132            81416850130</p> 	<p><b>ZC-M06-011</b>            大灯盖板LH            HEAD LMAP CASE RH            81416850131            81416850129</p> 	<p><b>ZC-M06-012</b>            保险杠支架RH            BUMPER BRACKET RH            81416146001            TG-S M,L&amp;LX</p> 
<p><b>ZC-M06-013</b>            保险杠支架LH            BUMPER BRACKET LH            81416146000            TG-S M,L&amp;LX</p> 	<p><b>ZC-M06-014</b>            保险杠亮条            GRILLE SURROUND CHROME            TG-S M,L&amp;LX</p> 	<p><b>ZC-M06-015</b>            杠边条RH            BUMPER BRACKET RH            81416100366            81416100368            TG-S M,L&amp;LX</p> 

# TG-S FOR MAN



<p><b>ZC-M06-016</b> 杠边条LH BUMPER BRACKET LH 81416100365 81416100367 TG-S M,L&amp;LX</p> 	<p><b>ZC-M06-017</b> 保险杠弯角RH BUMPER CORNER RH 81416140024 81416140028 TG-S M,L&amp;LX</p> 	<p><b>ZC-M06-018</b> 保险杠弯角LH BUMPER CORNER LH 81416140023 81416140027 TG-S M,L&amp;LX</p> 
<p><b>ZC-M06-019</b> 叶子板RH FENDER RH 81615100472 81615100470 81615100758 TG-S M,L&amp;LX</p> 	<p><b>ZC-M06-020</b> 叶子板LH FENDER LH 81615100473 81615100471 81615100759 TG-S M,L&amp;LX</p> 	<p><b>ZC-M06-021</b> 叶子板RH FENDER RH 81615100475 81615100477 81615100479 81615100481 81615100587 81615100589 81615100591 81615100593 81615100357 TG-S M,L&amp;LX</p> 
<p><b>ZC-M06-022</b> 叶子板LH FENDER LH 81615100474 81615100476 81615100478 81615100480 81615100586 81615100588 81615100590 81615100592 81615100358 TG-S M,L&amp;LX</p> 	<p><b>ZC-M06-023</b>叶 子板RH FENDER RH 81615100472 81615100470 81615100758 TG-S M,L&amp;LX</p> 	<p><b>ZC-M06-024</b>叶 子板LH FENDER LH 81615100473 81615100471 81615100759 TG-S M,L&amp;LX</p> 
<p><b>ZC-M06-025</b> 叶子板RH FENDER RH 81615100582 81615100584 81615100578 81615100580 81615100492 81615100758 81615100342 TG-S M,L&amp;LX</p> 	<p><b>ZC-M06-026</b> 叶子板LH FENDER LH 81615100589 81615100587 81615100585 81615100757 81615100491 TG-S M,L&amp;LX</p> 	<p><b>ZC-M06-027</b> 叶子板RH FENDER RH 81615100472 81615100470 81615100758 TG-S M,L&amp;LX</p> 
<p><b>ZC-M06-028</b> 叶子板LH FENDER LH 81615100473 81615100471 81615100759 TG-S M,L&amp;LX</p> 	<p><b>ZC-M06-029</b> 下脚踏板(ABS)(高位)RH FOOT STEP(ABS)(TOP)RH 81615100644 81615100680 81615100352 81615100742 TG-S M,L&amp;LX</p>  <p>22CM</p>	<p><b>ZC-M06-030</b> 下脚踏板(ABS)(高位)LH FOOT STEP(ABS)(TOP)LH 81615100643 81615100679 81615100353 81615100741 TG-S M,L&amp;LX</p>  <p>22CM</p>

# TG-S FOR MAN



<p><b>ZC-M06-031</b> 边肚下饰板RH REAR PILLAR RH 81612100602 81615100284 TG-S M,L&amp;LX</p> 	<p><b>ZC-M06-032</b> 边肚下饰板LH REAR PILLAR LH 81612100603 81615100285 TG-S M,L&amp;LX</p> 	<p><b>ZC-M06-033</b> 边肚下饰板RH REAR PILLAR RH 81612100602 81615100284 TG-S M,L&amp;LX</p> 
<p><b>ZC-M06-034</b> 边肚下饰板LH REAR PILLAR LH 81612100603 81615100285 TG-S M,L&amp;LX</p> 	<p><b>ZC-M06-035</b> 边肚下饰板RH REAR PILLAR RH 81612100616 81615100288 81615100346 TG-S M,L&amp;LX</p> 	<p><b>ZC-M06-036</b> 边肚下饰板LH REAR PILLAR LH 81612100617 81615100552 81615100347 TG-S M,L&amp;LX</p> 
<p><b>ZC-M06-037</b> 边肚下饰板RH REAR PILLAR RH 81615100366 81615100368 TG-S M,L&amp;LX</p> 	<p><b>ZC-M06-038</b> 边肚下饰板LH REAR PILLAR LH 81615100554 81615100555 TG-S M,L&amp;LX</p> 	<p><b>ZC-M06-039</b> 边肚下饰板RH REAR PILLAR RH 81615100364 81615100454 81612100726 TG-S M,L&amp;LX</p> 
<p><b>ZC-M06-040</b> 边肚下饰板LH REAR PILLAR LH 81615100363 81615100455 TG-S M,L&amp;LX</p> 	<p><b>ZC-M06-041</b> 倒车镜RH MIRROR RH 81637306551 TG-S M,L&amp;LX</p>  	<p><b>ZC-M06-042</b> 倒车镜LH MIRROR LH 81637306552 TG-S M,L&amp;LX</p>  
<p><b>ZC-M06-043</b> 倒车镜后盖RH MIRROR COVER RH 81637310356 TG-S M,L&amp;LX</p> 	<p><b>ZC-M06-044</b> 倒车镜后盖LH MIRROR COVER LH 81637310357 TG-S M,L&amp;LX</p> 	<p><b>ZC-M06-045</b> 倒车镜上盖RH MIRROR COVER RH 81637320074 TG-S M,L&amp;LX</p> 

# TG-S FOR MAN





<p><b>ZC-M06-046</b> 倒车镜上盖LH MIRROR COVER LH 81637320073 TG-S M,L&amp;LX</p> 	<p><b>ZC-M06-047</b> 倒车镜下盖RH MIRROR COVER RH 81637320076 TG-S M,L&amp;LX</p> 	<p><b>ZC-M06-048</b> 倒车镜下盖LH MIRROR COVER LH 81637320075 TG-S M,L&amp;LX</p> 
<p><b>ZC-M06-049</b> 倒车镜大镜片 MIRROR 81637336071</p> 	<p><b>ZC-M06-050</b> 倒车镜小镜片 MIRROR 81637336072</p> 	<p><b>ZC-M06-051</b> 车门 RH DOOR RH 81626004118 TG-S M,L&amp;LX</p> 
<p><b>ZC-M06-052</b> 车门 LH DOOR LH 81626004117 TG-S M,L&amp;LX</p> 	<p><b>ZC-M06-053</b> 车门 RH DOOR RH 81626004132 TG-S M,L&amp;LX</p> 	<p><b>ZC-M06-054</b> 车门 LH DOOR LH 81626004131 TG-S M,L&amp;LX</p> 
<p><b>ZC-M06-055</b> 导流罩 AIR DEFLECTOR 81629100130 TG-S M,L&amp;LX</p> 	<p><b>ZC-M06-056</b> 导流罩弯角RH PANEL CORNER RH 81629100138 TG-S M,L&amp;LX</p> 	<p><b>ZC-M06-057</b> 导流罩弯角LH PANEL CORNER LH 81629100139 TG-S M,L&amp;LX</p> 
<p><b>ZC-M06-058</b> 侧面板RH SIDE PLATE RH 81629100142 TG-S M,L&amp;LX</p> 	<p><b>ZC-M06-059</b> 侧面板LH SIDE PLATE LH 81629100143 TG-S M,L&amp;LX</p> 	<p><b>ZC-M06-060</b> 上脚踏板灯 SIDE LAMP 82253206007</p> 

















# TG-S FOR MAN







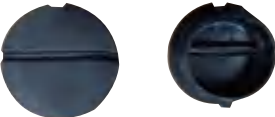









<p><b>ZC-M06-061</b> 雾灯盖板 RH FOG LAMP COVER RH 81416850094</p> <p>18CM</p> 	<p><b>ZC-M06-062</b> 雾灯盖板 LH FOG LAMP COVER LH 81416850095</p> <p>18CM</p> 	<p><b>ZC-M06-063</b> 挡泥板后边灯壳 MUDGUARD REAR SIDE LAMP COVER 81664400189 TG-S M,L&amp;LX</p>  
<p><b>ZC-M06-064</b> 杠防滑板 77.5 81416142184 81416142117 TG-S M,L&amp;LX</p> <p>77.5CM</p> 	<p><b>ZC-M06-065</b> 杠防滑板 BUMPER STEP PLATE BOTTOM 81416140041 81416140012 81416142183 81416142116 TG-S M,L&amp;LX</p> 	<p><b>ZC-M06-066</b> 遮阳罩 SUNVISOR 81637010046 8163701031 TG-S M,L&amp;LX</p> <p>221CM</p> <p>59.3CM 59.3CM 59.3CM</p> <p>36CM</p> 
<p><b>ZC-M06-067</b> 电镀倒车镜RH MIRROR RH 81637306560 81637306529 81637306534 TG-S M,L&amp;LX</p> 	<p><b>ZC-M06-068</b> 电镀倒车镜LH MIRROR LH 81637306561 81637306531 81637306533 TG-S M,L&amp;LX</p> 	<p><b>ZC-M06-069</b> 立柱护板RH COLUMN GUARD RH 81624100180 TG-S M,L&amp;LX</p> 
<p><b>ZC-M06-070</b> 立柱护板LH COLUMN GUARD LH 81624100179 TG-S M,L&amp;LX</p> 	<p><b>ZC-M06-071</b> 天窗 SKYLIGHT 81629416057 TG-S M,L&amp;LX</p> 	<p><b>ZC-M06-072</b> 蓄电池开关 BATTERY SWITCH 81255066121 81255066120 TG-S M,L&amp;LX</p> 
<p><b>ZC-M06-073</b> 护线盒接口 WIPE PROTECTOR ASSY TG-S M,L&amp;LX</p>  <p>(1) (2)</p>	<p><b>ZC-M06-074</b> 保险丝盒 FUSE BOX 81254410654(1) 81254410999(2) 81254410077(3) TG-S M,L&amp;LX</p>  <p>(1) (2) (3)</p>	<p><b>ZC-M06-075</b> 外A立柱 LH FRONT PILLAR GARNISH LH 81624100222 81624100224 TG-S M,L&amp;LX</p> 

















<p><b>ZC-M06-076</b> 外A立柱 RH FRONT PILLAR GARNISH RH 81624100223 81624100225 TG-S M,L&amp;LX</p> 	<p><b>ZC-M06-077</b> 外A立柱 LH FRONT PILLAR GARNISH LH 81624100230 81624100233 TG-S M,L&amp;LX</p> 	<p><b>ZC-M06-078</b> 外A立柱 RH FRONT PILLAR GARNISH RH 81624100227 81624100229 TG-S M,L&amp;LX</p> 
<p><b>ZC-M06-079</b> 外A立柱 LH FRONT PILLAR GARNISH LH 81624100230 81624100233 TG-S M,L&amp;LX</p> 	<p><b>ZC-M06-080</b> 外A立柱 RH FRONT PILLAR GARNISH RH 81624100227 81624100229 TG-S M,L&amp;LX</p> 	<p><b>ZC-M06-081</b> 面板合叶 HINGE PANEL 81624400042 TC-S</p> 
<p><b>ZC-M06-082</b> 面板合叶 PANEL HINGE 81611450004 TC-S</p> 	<p><b>ZC-M06-083</b> 挂档杆 HANGING LEVER 8132620043 TG-S M,L&amp;LX</p> 	<p><b>ZC-M06-084</b> 挂档杆 HANGING LEVER 8132620045 TG-S M,L&amp;LX</p> 
<p><b>ZC-M06-085</b> 地板压条LH FLOOR LAYERING LH 81615100787 TG-S M,L&amp;LX</p> 	<p><b>ZC-M06-086</b> 地板压条RH FLOOR LAYERING RH 81615100788 TG-S M,L&amp;LX</p> 	<p><b>ZC-M06-087</b> 地板压条LH FLOOR LAYERING LH 81615100791 TG-S M,L&amp;LX</p> 
<p><b>ZC-M06-088</b> 地板压条RH FLOOR LAYERING RH 81615100792 TG-S M,L&amp;LX</p> 	<p><b>ZC-M06-089</b> 工程车顶标记灯 TOP LAMP 81252076059 TG-S M,L&amp;LX</p> 	<p><b>ZC-M06-090</b>保 保险杠小圆盖LH COVER 81416850063 TG-S</p> 



<p><b>ZC-M06-091</b> 保 保险杠小圆盖RH COVER 81416850110 TG-S</p> 	<p><b>ZC-M06-092</b> 保险杠反转支架 BUMPER BRACKET 81417156016 TG-S</p> 	<p><b>ZC-M06-093</b> 车轮开口遮板 WHEEL OPENING SHIELD 81612100420 81612100422 TGX/TGS</p> 
<p><b>ZC-M06-094</b> 喷油器线束 TXL ECU 17P 对 4 孔前板+12*螺丝+橡胶+成型 +胶布+五 51254136417 51254136090 51254136256 51254136386 TGX TGS TGA</p> 	<p><b>ZC-M06-095</b> 玻璃升降器总成 RH 81626456054 TGX TGS</p> 	<p><b>ZC-M06-096</b> 玻璃升降器总成 LH 81626456055 TGX TGS</p> 
<p><b>ZC-M06-097</b> 车门带电机锁块LH LOCK DOOR INNER 81626806121 81626806143 TGX TGS</p> 	<p><b>ZC-M06-098</b> 车门带电机锁块RH LOCK DOOR INNER 81626806122 81626806142 TGX TGS</p> 	<p><b>ZC-M06-099</b> 玻璃摇把 REGULATOR HANDLE 81626416069 TGA TGS</p> 
<p><b>ZC-M06-100</b> 雨 刮电机 WIPER MOTOR 81264016140 81264016143 81264016141 81264016135 TGX TGS TGA</p> 	<p><b>ZC-M06-101</b> 防雾灯固定支架RH FOG LAMP BRACKET RH 81251400140 TGX TGS</p> 	<p><b>ZC-M06-102</b> 防雾灯固定支架LH FOG LAMP BRACKET LH 81251400141 TGX TGS</p> 
<p><b>ZC-M06-103</b> 杠供气窄下面 AIR DUCT NARROW 81416140009 TGS</p> 	<p><b>ZC-M06-104</b> 杠供气窄 AIR DUCT LEFT, UPPER 81416140031 TGS</p> 	<p><b>ZC-M06-105</b> 杠供气窄 AIR DUCT LEFT, UPPER 81416140032 TGS</p> 















# FOR MAN TG-S



<p><b>ZC-M06-106</b> 保险杠下装饰件 BUMPER LOWER TRIM 81416140012 81416140041 TGS TGA</p> 	<p><b>ZC-M06-107</b> 机油盖 FILTER HEAD COVER 51125046004 51125040007 TGX/TGS</p> 	<p><b>ZC-M06-108</b> 机油盖 FILTER HEAD COVER 51125046003 51125046006 TGX/TGS</p> 
<p><b>ZC-M06-109</b> 车窗晴雨挡 WINDOW DEFLECTOR 51125046003 51125046006 TGX TGS TGA TGM TGL</p> 	<p><b>ZC-M06-110</b> 挂挡杆皮盖 GEAR SHIFT LEVER BOOT CUP 81964010170 TGX TGS TGA TGM</p> 	<p><b>ZC-M06-111</b> 挂挡杆皮 GEAR SHIFT LEVER BOOT 81964200521 81964200563 TGX TGS TGA TGM</p> 
<p><b>ZC-M06-112</b> 消声器板 EXHAUST MUFFLER COVER 81151100362</p> 	<p><b>ZC-M06-113</b> 雨刮连杆短 (860CM) WIPER LINKAGE ASSEMBLY 81264116113 TGA TGX TGL</p> 	<p><b>ZC-M06-114</b> 82X22.5 CM车轮开口遮板 EXTENSION OF THE MOUNTAIN FIXER RIGHT WIDE 81612100536 81612100394 MAN</p> 
<p><b>ZC-M06-115</b> 82X22.5 CM车轮开口遮板 EXTENSION OF THE MOUNTAIN FIXER LOWER LEFT 81612100537 81612100395 MAN</p> 	<p><b>ZC-M06-116</b> 82X26X1.5 CM车轮开口遮板 EXTENSION OF THE MOUNTAIN FENDER RIGHT WIDE 81612105416 MAN</p> 	<p><b>ZC-M06-117</b> 82X26X1.5 CM车轮开口遮板 EXTENSION OF THE MOUNTAIN FENDER UPPER WIDE 81612105417 MAN</p> 
<p><b>ZC-M06-118</b> 58.5X36X15电瓶箱盖 BATTERY GUARD 81418600230 81418600220 81416800242 81418600241 MAN TGS EURO 6 / TGX EURO 6</p> 	<p><b>ZC-M06-119</b> 车门锁块 LOCK DOOR INNER 81626806121 81626806143 MAN</p> 	<p><b>ZC-M06-120</b> 车门锁块 LOCK DOOR INNER 81626806122 81626806142 MAN</p> 

# FOR MAN TG-S



<p><b>ZC-M06-121</b> 防蝇网 PLASA INSECTE 81062016024 TGA TGS</p> 	<p><b>ZC-M06-122</b> 挡泥板内衬LH MUDGUARD LH INNER 81612300211 81612300213 MAN TGS</p>  <p>126CM</p>	<p><b>ZC-M06-123</b> 挡泥板内衬RH MUDGUARD RH INNER 81612300214 81612300212 MAN TGS</p>  <p>126CM</p>
<p><b>ZC-M06-124</b> FAN BEARING COMPLETE 51066095012 51066095004 51066040088 51066035006 51066095012 MAN TGA</p> 	<p><b>ZC-M06-125</b> SUPORT ARC 81413016158 81413016104 81413016126 81413016156 81413016158 81413016104 81413016126 81413016156 MAN</p> 	<p><b>ZC-M06-126</b> WATER PUMP INTERMEDIATE HOSE REPAIR KIT 51981820026 51981820050 51981820003 MAN</p> 
<p><b>ZC-M06-127</b> 保险杠反转支架 BUMPER BRACKET 81417156016 MAN</p> 	<p><b>ZC-M06-128</b> 车架前横梁 CHASSIS BEAM FRONT 81412805282 81412803442 MAN TGA</p> 	<p><b>ZC-M06-129</b> 挡泥板中段单轮 MUDGUARD UPPER 81664106612 MAN</p>  <p>52CM</p>
<p><b>ZC-M06-130</b> 挡泥板后段单轮 MUDGUARD REAR SECTION 81664106608 81664106609 MAN</p>  <p>52CM</p>	<p><b>ZC-M06-131</b> 护线盒接口 WIPE PROTECTOR ASSY TG-S M,L&amp;LX</p>  <p>(3) (4)</p>	<p><b>ZC-M06-132</b>面 板盖板 PANEL COVER 81611400032</p> 
<p><b>ZC-M06-133</b> 保险杠防虫网 BUMPER INSECT-PROOF NET</p> 	<p><b>ZC-M06-134</b> 进气扁管侧盖板 SIDE COVER PLATE OF INTAKE FLAT TUBE 81082015940</p> 	<p><b>ZC-M06-135</b> 电瓶箱底座 BATTERY BOX BASE 81418605385</p> 



# TG-S/TG-A TRACTORS

## FOR MAN



### ZC-M06R-001

保险杠  
BUMPER  
81416105451 81416105664  
81416105517  
TG-S,TG-A TRACTORS



### ZC-M06R-002

保险杠RH  
BUMPER RH  
81416105508 81416105598  
81416105610  
TG-S,TG-A TRACTORS



### ZC-M06R-003

保险杠LH  
BUMPER LH  
81416105507 81416105597  
81416105609  
TG-S,TG-A TRACTORS



### ZC-M06R-004

带销螺栓  
COTTER BOLT  
81911015183  
TG-S M,L&LX



### ZC-M06R-005

大灯框RH  
HEAD LAMP CASE RH  
81251155008  
TG-S,TG-A TRACTORS



### ZC-M06R-006

大灯框LH  
HEAD LAMP CASE LH  
81251155007  
TG-S,TG-A TRACTORS



### ZC-M06R-007

杠边条RH  
BUMPER BRACKETRH  
81416100376  
81416100378  
TG-S,TG-A TRACTORS



### ZC-M06R-008

杠边条LH  
BUMPER BRACKET LH  
81416100375  
81416100377  
TG-S,TG-A TRACTORS



### ZC-M06R-009

遮阳罩(205cm\*38cm)  
SUNCISOR(205cm\*38cm)  
81637010060 81637010047  
TG-S,TG-A TRACTORS

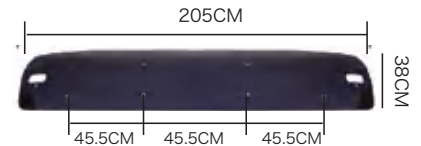

### ZC-M06R-010

遮阳罩支架  
SUNCISOR MOUNTING KIT  
81637350032  
TG-S,TG-A TRACTORS



### ZC-M06R-011

台阶低位  
STEP BRACKET  
81615100809  
TG-S,TG-A TRACTORS



### ZC-M06R-012

台阶防滑板  
STEP  
81615400022  
TG-S,TG-A TRACTORS



### ZC-M06R-013

台阶防滑板配件  
FOOT STEP  
81615600023  
TG-S,TG-A TRACTORS



### ZC-M06R-014

台阶灯  
FOOT STEP SIDE LAMP  
81251036066  
TG-S,TG-A TRACTORS



### ZC-M06R-015

遮阳罩灯底座 LH  
SUNVISOR LAMP BASE LH  
81637015005  
TG-S,TG-A TRACTORS





# TG-S/TG-A TRACTORS

## FOR MAN



### ZC-M06R-016

遮阳罩灯底座 RH  
SUNVISOR LAMP BASE RH  
81637015006  
TG-S,TG-A TRACTORS



### ZC-M06R-017

遮阳罩灯  
SUNVISOR LAMP  
81252606121  
TG-S,TG-A TRACTORS



### ZC-M06R-018

台阶灯玻璃/台阶灯外罩  
FOOT STEP SIDE LAMP GLASS  
FOOT STEP SIDE LAMP COVER  
TG-S,TG-A TRACTORS



(1)

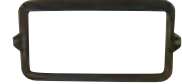

(2)

### ZC-M06R-019

保险杠饰盖RH  
TRIM(BUMPER)RH  
81416105529  
81416105531  
TG-S,TG-A TRACTORS



### ZC-M06R-020

保险杠饰盖LH  
TRIM(BUMPER)LH  
81416105530  
81416105532  
TG-S,TG-A TRACTORS



### ZC-M06R-021

保险杠饰盖LH  
TRIM(BUMPER)LH  
81416105535 81416105577  
TGX



### ZC-M06R-022

保险杠饰盖RH  
TRIM(BUMPER)RH  
81416105536 81416105578  
TGX



### ZC-M06R-023

保险杠饰盖中  
TRIM(BUMPER)MIDDLE  
81416105570  
TGX



### ZC-M06R-024

保险杠支架LH  
BUMPER BRACKET LH  
82416105145  
TGX TGS



### ZC-M06R-025

保险杠支架RH  
BUMPER BRACKET RH  
82416105144  
TGX TGS



### ZC-M06R-026

保险杠支架LH  
BUMPER BRACKET LH  
81416105575  
TGX TGS



### ZC-M06R-027

保险杠支架RH  
BUMPER BRACKET RH  
81416105574  
TGX TGS



### ZC-M06R-028

TGS台阶低位配件一个装4片  
ANGLE  
81615400032  
TGX TGS

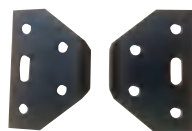

### ZC-M06R-029

TGS台阶低位全套  
STEP COMPLETELY  
81615105187  
81615006170  
TGX TGS



### ZC-M06R-030















工程车铁杠RH  
BUMPER  
81416105610 81416105524  
81416105612  
TGX

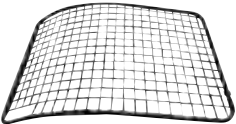

# TG-S/TG-A TRACTORS

## FOR MAN



<p><b>ZC-M06R-031</b> 工程车铁杠LH BUMPER 81416105609 81416105523 81416105611 TGX</p> 	<p><b>ZC-M06R-032</b> 杠网卡件 CLIP 81251400096 TGX TGS</p> 	<p><b>ZC-M06R-033</b> 脚踏板组装 BUMPER LOWER STEP SET 81416155101 TGS</p> 
<p><b>ZC-M06R-034</b> 脚踏板防滑板 BUMPER LOWER STEP SET 81416150045 TGS</p> 	<p><b>ZC-M06R-035</b> 脚踏板条 BUMPER LOWER STEP PLATE 81416152147 TGX/TGS</p> 	<p><b>ZC-M06R-036</b> 散热器保护装置 BUMPER LOWER REINFORCEMENT 81062015140 TGX/TGS</p> 
<p><b>ZC-M06R-037</b> 前照灯防护栅网 HEADLAMP PROTECTION GRID 81416305047 TGX/TGS</p> 	<p><b>ZC-M06R-038</b> 车门板RH DOOR INSIDE GARNISH BOARD RH 81626306106 81626306108 TG-X</p> 	<p><b>ZC-M06R-039</b> 车门板LH DOOR INSIDE GARNISH BOARD LH 81626306105 81626306109 TG-X</p> 
<p><b>ZC-M06R-040</b> 车门板拉手 DOOR PANEL HANDLE RH 81626304156</p> 	<p><b>ZC-M06R-041</b> 车门板拉手 DOOR PANEL HANDLE LH 81626304155</p> 	<p><b>ZC-M06R-042</b> 叶子板边条 LEAF LATH RH 81626416094</p> 
<p><b>ZC-M06R-043</b> 叶子板边条 LEAF LATH LH 81626416093</p> 	<p><b>ZC-M06R-044</b> 中网亮条 GRILLE STRIP 81611500156</p> 	<p><b>ZC-M06R-045</b>面 板中网 PANEL MID-NET 81611506111</p> 

# TG-A XXL













## FOR MAN

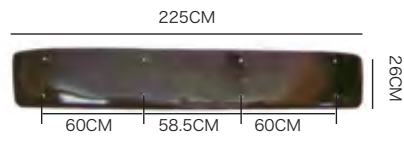

<p><b>ZC-M07-001</b>            面板            FRONT PANEL            81611100053 81611100047            TG-A XXL XLX&amp;XL</p>  <p>205CM 76CM</p>	<p><b>ZC-M07-002</b>            面板中网            GRILLE            81611506050 81611500111            TG-A XXL XLX&amp;XL</p> 	<p><b>ZC-M07-003</b>            外包角ABS RH            PANEL CPRNER(OUTSIDE)RH            81624100090            TG-A XXL XLX&amp;XL</p> 
<p><b>ZC-M07-004</b>            外包角ABS LH            PANEL CPRNER(OUTSIDE)LH            81624100089            TG-A XXL XLX&amp;XL</p> 	<p><b>ZC-M07-005</b>            内包角ABS RH            PANEL CPRNER(INNER)RH            81624100092            TG-A XXL XLX&amp;XL</p> 	<p><b>ZC-M07-006</b>            内包角ABS LH            PANEL CPRNER(INNER) LH            81624100091            TG-A XXL XLX&amp;XL</p> 
<p><b>ZC-M07-007</b>            外包角SMC RH            PANEL CPRNER(OUTSIDE)RH            81624100048            TG-A XXL XLX&amp;XL</p> 	<p><b>ZC-M07-008</b>            外包角SMC LH            PANEL CPRNER(OUTSIDE)LH            81624100049            TG-A XXL XLX&amp;XL</p> 	<p><b>ZC-M07-009</b>            内包角SMC RH            PANEL CPRNER(INNER)RH            81624100046            TG-A XXL XLX&amp;XL</p> 
<p><b>ZC-M07-010</b>            内包角SMC LH            PANEL CPRNER(INNER)LH            81624100047            TG-A XXL XLX&amp;XL</p> 	<p><b>ZC-M07-011</b>            包角下盖子RH            BUMPER COVER RH            81624400050 81624400041            TG-A XXL XLX&amp;XL</p> 	<p><b>ZC-M07-012</b>            包角下盖子LH            BUMPER COVER LH            81624400049 81624400039            TG-A XXL XLX&amp;XL</p> 
<p><b>ZC-M07-013</b>            字牌            MARK            81978400329 81978400321            81978400319 81978700126            TG-A XXL XLX&amp;XL</p> 	<p><b>ZC-M07-014</b>            杠中网            CENTRAL BUMPER            81416850053 81416850033            81416850044 81416850123            TG-A XXL XLX&amp;XL</p> 	<p><b>ZC-M07-015</b>            保险杠            BUMPER            81416100306 81416100305            TG-A XXL XLX&amp;XL</p> 

# TG-A XXL FOR MAN



<p><b>ZC-M07-016</b> 杠小圆盖 BUMPER COVER 81416850029 TG-A XXL XLX&amp;XL</p> 	<p><b>ZC-M07-017</b> 杠小方盖 BUMPER COVER 81466850031 TG-A XXL XLX&amp;XL</p> 	<p><b>ZC-M07-018</b> 杠小方盖 BUMPER COVER 81416850041 TG-A XXL XLX&amp;XL</p> 
<p><b>ZC-M07-019</b> 杠小方盖 BUMPER COVER 81416850040 81416850055 81416850037 TG-A XXL XLX&amp;XL</p> 	<p><b>ZC-M07-020</b> 遮阳罩(225cm*26cm) SUNCISOR (225cm*26cm) 81637010044 81637010033 TG-A XXL XLX&amp;XL</p> 	<p><b>ZC-M07-021</b> 遮阳罩支架 SUNVISOR MOUNTING KIT 81637350028 81637310283 TG-A XXL XLX&amp;XL</p> 
<p><b>ZC-M07-022</b> 杠边条RH BUMPER BRACKET RH 81416100232 81416100314 TG-A XXL XLX&amp;XL</p> 	<p><b>ZC-M07-023</b> 杠边条LH BUMPER BRACKET LH 81416100231 81416100315 TG-A XXL XLX&amp;XL</p> 	<p><b>ZC-M07-024</b> 保险杠弯角RH BUMPER CORNER RH 81416100228 TG-A XXL XLX&amp;XL</p> 
<p><b>ZC-M07-025</b> 保险杠弯角LH BUMPER CORNER LH 81416100227 TG-A XXL XLX&amp;XL</p> 	<p><b>ZC-M07-026</b> 杠防滑条 BUMPER STEP 81416102882 TG-A XXL XLX&amp;XL</p> 	<p><b>ZC-M07-027</b> 杠防滑条 BUMPER STEP 81416102881 TG-A XXL XLX&amp;XL</p> 
<p><b>ZC-M07-028</b> 大灯玻璃RH HEAD LAMP GLASS RH 81251100081 TG-A XXL XLX&amp;XL</p> 	<p><b>ZC-M07-029</b> 大灯玻璃LH HEAD LAMP GLASS LH 81251100080 TG-A XXL XLX&amp;XL</p> 	<p><b>ZC-M07-030</b> 大灯皮RH HEAD LAMP RUBBER RH 81251110051 TG-A XXL XLX&amp;XL</p> 

# TG-A XXL

## FOR MAN



<p><b>ZC-M07-031</b>            大灯皮LH            HEAD LAMP RUBBER LH            81251110050            TG-A XXL XLX&amp;XL</p> 	<p><b>ZC-M07-032</b>            前大灯RH            HEAD LAMP RH            81251016420 81251016448            81251016450            TG-A XXL XLX&amp;XL</p> 	<p><b>ZC-M07-033</b>            前大灯LH            HEAD LAMP LH            81251016421 81251016449            81251016451            TG-A XXL XLX&amp;XL</p> 
<p><b>ZC-M07-034</b>            大灯固定支架RH            HEAD LAMP BRACKET RH            81251400120            TG-A XXL XLX&amp;XL</p> 	<p><b>ZC-M07-035</b>            大灯固定支架LH            HEAD LAMP BRACKET LH            81251400120            TG-A XXL XLX&amp;XL</p> 	<p><b>ZC-M07-036</b>            前大灯带皮RH            HEAD LAMP WITH RUBBER RH            81251016460            81251016470            TG-A XXL XLX&amp;XL</p> 
<p><b>ZC-M07-037</b>            前大灯带皮LH            HEAD LAMP WITH RUBBER LH            81251016461            81251016471            TG-A XXL XLX&amp;XL</p> 	<p><b>ZC-M07-038</b>            防雾灯RH            FOG LAMP RH            81253206112 81253206092            TG-A XXL XLX&amp;XL</p> 	<p><b>ZC-M07-039</b>            防雾灯LH            FOG LAMP LH            81253206111 81253206091            TG-A XXL XLX&amp;XL</p> 
<p><b>ZC-M07-040</b>            防雾灯RH            FOG LAMP RH            81253206114            TG-A XXL XLX&amp;XL</p> 	<p><b>ZC-M07-041</b>            防雾灯LH            FOG LAMP LH            81253206114            TG-A XXL XLX&amp;XL</p> 	<p><b>ZC-M07-042</b>            防雾灯RH            FOG LAMP RH            81253206090            TG-A XXL XLX&amp;XL</p> 
<p><b>ZC-M07-043</b>            防雾灯LH            FOG LAMP LH            81253206089            TG-A XXL XLX&amp;XL</p> 	<p><b>ZC-M07-044</b>            防雾灯玻璃            FOG LAMP GLASS            TG-A XXL XLX&amp;XL</p> 	<p><b>ZC-M07-045</b>            防雾灯玻璃            FOG LAMP GLASS            TG-A XXL XLX&amp;XL</p> 



# FOR MAN TG-A XXL



<p><b>ZC-M07-046</b> 防雾灯灯罩 FOG LAMP CASE TG-A XXL XLX&amp;XL</p> 	<p><b>ZC-M07-047</b> 防雾灯灯罩 FOG LAMP CASE TG-A XXL XLX&amp;XL</p> 	<p><b>ZC-M07-048</b> 防雾灯固定支架RH FOG LAMP BRACKET RH 81252450144 TG-A XXL XLX&amp;XL</p> 
<p><b>ZC-M07-049</b> 防雾灯固定支架LH FOG LAMP BRACKET LH 81252450144 TG-A XXL XLX&amp;XL</p> 	<p><b>ZC-M07-050</b> 后灯RH TAIL LAMP RH 81252256545 81252256541 81252256249 81252256551 TG-A XXL XLX&amp;XL</p> 	<p><b>ZC-M07-051</b> 后灯LH TAIL LAMP LH 81252256544 81252256540 81252256248 81252256550 TG-A XXL XLX&amp;XL</p> 
<p><b>ZC-M07-052</b> 后灯罩RH TAIL LAMP LENS RH 81252256060 TG-A XXL XLX&amp;XL</p> 	<p><b>ZC-M07-053</b> 后灯罩LH TAIL LAMP LENS LH 81252256059 TG-A XXL XLX&amp;XL</p> 	<p><b>ZC-M07-054</b> 上脚踏板灯 STEP LAMP 81253206116 81253206118 TG-A XXL XLX&amp;XL</p> 
<p><b>ZC-M07-055</b> 上脚踏板灯罩 STEP LAMP COVER TG-A XXL XLX&amp;XL</p> 	<p><b>ZC-M07-056</b> 后灯RH TAIL LAMP RH 81252256523 81252286028 TG-A XXL XLX&amp;XL</p> 	<p><b>ZC-M07-057</b> 后灯LH TAIL LAMP LH 81252256524 81252286027 TG-A XXL XLX&amp;XL</p> 
<p><b>ZC-M07-058</b> 后灯罩RH TAIL LAMP LENS RH 81252296051 81252286055 TG-A XXL XLX&amp;XL</p> 	<p><b>ZC-M07-059</b> 后灯罩LH TAIL LAMP LENS LH 81252296051 81252286055 TG-A XXL XLX&amp;XL</p> 	<p><b>ZC-M07-060</b> 后灯RH TAIL LAMP RH 81252256532 TG-A XXL XLX&amp;XL</p> 



# TG-A XXL













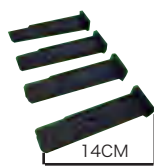

## FOR MAN



<p><b>ZC-M07-061</b> 后灯LH TAIL LAMP LH 81252256531 TG-A XXL XLX&amp;XL</p> 	<p><b>ZC-M07-062</b> 后灯罩 TAIL LAMP LENS 81252256538 TG-A XXL XLX&amp;XL</p> 	<p><b>ZC-M07-063</b> 尾灯示宽灯 SIDE LAMP 81252606116 TG-A XXL XLX&amp;XL</p> 
<p><b>ZC-M07-064</b> 挡泥板内衬 MUDGUARD INNER 81664106638 81664100486 TG-A XXL XLX&amp;XL</p> 	<p><b>ZC-M07-065</b> 挡泥板护板 MUDGUARD BOARD 81664100483 TG-A XXL XLX&amp;XL</p> 	<p><b>ZC-M07-066</b> 挡泥板拉带(新款) MUDGUARD REAR RUBBER 81664400192 TG-A XXL XLX&amp;XL</p> 
<p><b>ZC-M07-067</b> 挡泥板(新款中) MUDGUARD 81664106606 81664106607 TG-A XXL XLX&amp;XL</p> 	<p><b>ZC-M07-068</b> 挡泥板(新款后)RH MUDGUARD RH 81664106625 81664106604 TG-A XXL XLX&amp;XL</p> 	<p><b>ZC-M07-069</b> 挡泥板(新款后)LH MUDGUARD LH 81664106625 81664106604 TG-A XXL XLX&amp;XL</p> 
<p><b>ZC-M07-070</b> 挡泥板小圆盖 MUDGUARD COVER 81664400187 TG-A XXL XLX&amp;XL</p> 	<p><b>ZC-M07-071</b> 挡泥板(新款前)RH MUDGUARD RH 81664106573 81664106599 81664106592 TG-A XXL XLX&amp;XL</p> 	<p><b>ZC-M07-072</b> 挡泥板(新款前)LH MUDGUARD LH 81664106593 81664106599 81664106574 TG-A XXL XLX&amp;XL</p> 
<p><b>ZC-M07-073</b> 挡泥板(新款前后)RH MUDGUARD RH 81664100462 TG-A XXL XLX&amp;XL</p> 	<p><b>ZC-M07-074</b> 挡泥板(新款前后)LH MUDGUARD LH 81664100463 TG-A XXL XLX&amp;XL</p> 	<p><b>ZC-M07-075</b> 挡泥板内衬RH FRONT MUDGUARD RH 81612300210 81612300148 81612300208 81612300140 81612300022 TG-A XXL XLX&amp;XL</p> 

# TG-A XXL FOR MAN



<p><b>ZC-M07-076</b> 挡泥板内衬LH FRONT MUDGUARD LH 81612300209 81612300147 81612300207 81612300141 81612300021 TG-A XXL XLX&amp;XL</p> 	<p><b>ZC-M07-077</b> 挡泥板内衬盖 MUDGUARD COVER 81612300108 TG-A XXL XLX&amp;XL</p> 	<p><b>ZC-M07-078</b> 挡泥板灯 SIDE LAMP 81252606101 81252606096 81252606097 TG-A XXL XLX&amp;XL</p> 
<p><b>ZC-M07-079</b> 挡泥板皮(老款) MUDGUARD REAR RUBBER 81664100226 TG-A XXL XLX&amp;XL</p> 	<p><b>ZC-M07-080</b> 前轮后挡泥板 REAR MUDGUARD 81612100462 81612100183 TG-A XXL XLX&amp;XL</p> 	<p><b>ZC-M07-081</b> 前轮后挡泥板内衬 REAR MUDGUARD 81612100462 J TG-A XXL XLX&amp;XL</p> 
<p><b>ZC-M07-082</b> 前轮后挡泥板叶子板RH FENDER SIDE COVER RH 81664100306 81664100308 81612100443 TG-A XXL XLX&amp;XL</p> 	<p><b>ZC-M07-083</b> 前轮后挡泥板叶子板LH FENDER SIDE COVER LH 81664100307 81664100309 81612100441 TG-A XXL XLX&amp;XL</p> 	<p><b>ZC-M07-084</b> 电瓶箱盖(大号) BATTERY COVER 81418606090 81418600139 TG-A XXL XLX&amp;XL</p> 
<p><b>ZC-M07-085</b> 挡泥板(老款中) MUDGUARD 81664106086 TG-A XXL XLX&amp;XL</p> 	<p><b>ZC-M07-086</b> 挡泥板(老款前)LH MUDGUARD LH 81664100293 81664100169 81664100299 TG-A XXL XLX&amp;XL</p> 	<p><b>ZC-M07-087</b> 挡泥板(老款前)RH MUDGUARD RH 81664100294 81664100300 81664100194 TG-A XXL XLX&amp;XL</p> 
<p><b>ZC-M07-088</b> 挡泥板(老款后)RH MUDGUARD RH 81664106592 81664100172 TG-A XXL XLX&amp;XL</p> 	<p><b>ZC-M07-089</b> 挡泥板(老款后)LH MUDGUARD LH 81664106593 81664100173 TG-A XXL XLX&amp;XL</p> 	<p><b>ZC-M07-090</b> 挡泥板内衬 MUDGUARD INNER 81664100195 81664100196 TG-A XXL XLX&amp;XL</p> 

# TG-A XXL

## FOR MAN



<p><b>ZC-M07-091</b> 挡泥板护板 MUDGUARD BOARD 81664100336 TG-A XXL XLX&amp;XL</p> 	<p><b>ZC-M07-092</b> 大倒车镜LH MIRROR LH 81637306482 81637306480 81637306496 81637306430 TG-A XXL XLX&amp;XL</p> 	<p><b>ZC-M07-093</b> 大倒车镜RH MIRROR RH 81637306483 81637306481 81637306497 81637306399 TG-A XXL XLX&amp;XL</p> 
<p><b>ZC-M07-094</b> 小倒车镜RH MIRROR RH 81637306512 81637306444 81637306518 81637306409 TG-A XXL XLX&amp;XL</p> 	<p><b>ZC-M07-095</b> 小倒车镜LH MIRROR LH 81637306513 81637306443 81637306519 81637306410 TG-A XXL XLX&amp;XL</p> 	<p><b>ZC-M07-096</b> 大倒车镜后盖RH MIRROR COVER BIG RH 81637320060 81637320055 81637320064 TG-A XXL XLX&amp;XL</p> 
<p><b>ZC-M07-097</b> 大倒车镜后盖LH MIRROR COVER BIG LH 81637320059 81637320054 81637320063 TG-A XXL XLX&amp;XL</p> 	<p><b>ZC-M07-098</b> 小倒车镜后盖RH MIRROR COVER SMALL RH 81637320062 81637320056 81637320066 TG-A XXL XLX&amp;XL</p> 	<p><b>ZC-M07-099</b> 小倒车镜后盖LH MIRROR COVER SMALL LH 81637320061 81637320057 81637320065 TG-A XXL XLX&amp;XL</p> 
<p><b>ZC-M07-100</b> 倒车镜支架盖RH MIRROR ARM WITH WIRE AND BASE RH 81637316618 (81637316614) TG-A XXL XLX&amp;XL</p> 	<p><b>ZC-M07-101</b> 倒车镜支架盖LH MIRROR ARM WITH WIRE AND BASE LH 81637316617 (81637316613) TG-A XXL XLX&amp;XL</p> 	<p><b>ZC-M07-102</b> 倒车镜支架盖RH MIRROR HOLDER CAP RH 81637310260 81637310312 TG-A XXL XLX&amp;XL</p> 
<p><b>ZC-M07-103</b> 倒车镜支架盖LH MIRROR HOLDER CAP LH 81637310261 81637310313 TG-A XXL XLX&amp;XL</p> 	<p><b>ZC-M07-104</b> 大倒车镜镜片 MIRROR GLASS BIG 81637336049 81637336053 TG-A XXL XLX&amp;XL</p> 	<p><b>ZC-M07-105</b> 小倒车镜镜片 MIRROR GLASS SMALL 81637336037 81637336085 81637336057 TG-A XXL XLX&amp;XL</p> 

# TG-A XXL FOR MAN



<p><b>ZC-M07-106</b> 车门镜 DOOR MIRROR 81637306451 81637306573 81637306575 81637306352 81637306449 TG-A XXL XLX&amp;XL</p> 	<p><b>ZC-M07-107</b> 车门镜片 DOOR MIRROR GLASS 81637336043 81637360069 TG-A XXL XLX&amp;XL</p> 	<p><b>ZC-M07-108</b> 台阶防滑板上 UPPER STEP 81615100273 TG-A XXL XLX&amp;XL</p> 
<p><b>ZC-M07-109</b> 台阶防滑板中 UPPER STEP 81615110001 81615100421 81615110000 81615100272 TG-A XXL XLX&amp;XL</p> 	<p><b>ZC-M07-110</b> 台阶防滑板下 LOWER STEP 81615105187 TG-A XXL XLX&amp;XL</p> 	<p><b>ZC-M07-111</b> 叶子板RH FENDER RH 81615100826 81615100824 81615100706 81615100402 81615100332 81615100042 81615100400 81615100474 TG-A XXL XLX&amp;XL</p> 
<p><b>ZC-M07-112</b> 叶子板LH FENDER LH 81615100827 81615100825 81615100705 81615100401 81615100331 81615100043 81615100399 81615100473 TG-A XXL XLX&amp;XL</p> 	<p><b>ZC-M07-113</b> 上脚踏板支架RH STEP BRACKET RH 81615106006 81615405078 TG-A XXL XLX&amp;XL</p> 	<p><b>ZC-M07-114</b> 上脚踏板支架LH STEP BRACKET LH 81615106007 81615405075 TG-A XXL XLX&amp;XL</p> 
<p><b>ZC-M07-115</b> 车门下护板RH FENDER RH 81626100024 81626100018 TG-A XXL XLX&amp;XL</p> 	<p><b>ZC-M07-116</b> 车门下护板LH FENDER LH 81626100023 81626100019 TG-A XXL XLX&amp;XL</p> 	<p><b>ZC-M07-117</b> 下脚踏板(SMC)(低位)RH STEP PANEL(SMC)(LOW)RH 81615100752 81615100374 81615100802 TG-A XXL XLX&amp;XL</p> 
<p><b>ZC-M07-118</b> 下脚踏板(SMC)(低位)LH STEP PANEL(SMC)(LOW)LH 81615100751 81615100333 81615100781 TG-A XXL XLX&amp;XL</p> 	<p><b>ZC-M07-119</b> 下脚踏板盖 STEP GARNISH COVER 81416850538 81416850536 G 81416850468 81416850826 G 81416850443 81615100823 TG-A XXL XLX&amp;XL</p> 	<p><b>ZC-M07-120</b> 上脚踏板灯 CORNER LAMP 81253206115 81253206117 81253206101 81253206094 TG-A XXL XLX&amp;XL</p> 

# TG-A XXL

## FOR MAN



### ZC-M07-121

上脚踏板灯罩  
CORNER LAMP COVER  
TG-A XXL XLX&XL



### ZC-M07-122

叶子板RH  
FENDER RH  
81615100408 81615100410  
81615100378 81615100414  
81615100362  
TG-A XXL XLX&XL



### ZC-M07-123

叶子板LH  
FENDER LH  
81615100409 81615100411  
81615100379 81615100415  
81615100361  
TG-A XXL XLX&XL



### ZC-M07-124

外A立柱RH  
FRONT PILLAR GARNISH RH  
81624100042  
82624100016  
TG-A XXL XLX&XL



### ZC-M07-125

外A立柱LH  
FRONT PILLAR GARNISH LH  
81624100043  
82624100015  
TG-A XXL XLX&XL



### ZC-M07-126

外A立柱护板RH  
FRONT PILLAR GARNISH COVER RH  
81637310296  
81624100144



### ZC-M07-127

外A立柱护板LH  
FRONT PILLAR GARNISH COVER LH  
81637310297  
81624100143



### ZC-M07-128

外A立柱内盖板RH  
PILLAR COVER RH  
81624400034  
TG-A XXL XLX&XL



### ZC-M07-129

外A立柱内盖板LH  
PILLAR COVER LH  
81624400035  
TG-A XXL XLX&XL



### ZC-M07-130

护风罩(配765)  
FAN COVER  
81066200186  
TG-A XXL XLX&XL



### ZC-M07-131

护风罩(配845)  
FAN COVER  
81066200187  
TG-A XXL XLX&XL



### ZC-M07-132

护风罩(配920)  
FAN COVER  
81066200188  
TG-A XXL XLX&XL



### ZC-M07-133

护风罩(内)  
FAN COVER(INNER)  
81066200134  
TG-A XXL XLX&XL



### ZC-M07-134

加装副水壶  
WATER TANK  
TG-A XXL XLX&XL



### ZC-M07-135













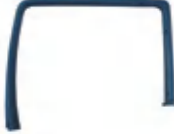

加装副水壶  
WATER TANK  
TG-A XXL XLX&XL





# TG-A XXL FOR MAN















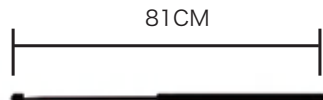

<p><b>ZC-M07-136</b> 雨刮水壶 WATER TANK 81264810079 81264810085 TG-A XXL XLX&amp;XL</p> 	<p><b>ZC-M07-137</b> 雨刮电机 WATER TANK MOTOR 81264856033 TG-A XXL XLX&amp;XL</p> 	<p><b>ZC-M07-138</b> 车门板RH DOOR INSIDE GARNISH BOARD RH 81626305104 TG-A XXL XLX&amp;XL</p> 
<p><b>ZC-M07-139</b> 车门板LH DOOR INSIDE GARNISH BOARD LH 81626305103 TG-A XXL XLX&amp;XL</p> 	<p><b>ZC-M07-140</b> 窗框RH DOOR FRAME RH 81626300089 TG-A XXL XLX&amp;XL</p> 	<p><b>ZC-M07-141</b> 窗框LH DOOR FRAME LH 81626300090 TG-A XXL XLX&amp;XL</p> 
<p><b>ZC-M07-142</b> 转向柱开关 STEERING COLUMN SWITCH 81255090157 TG-A XXL XLX&amp;XL</p> 	<p><b>ZC-M07-143</b> 车板小拉手RH INSIDE DOOR HANDLE RH 81626416068 TG-A XXL XLX&amp;XL</p> 	<p><b>ZC-M07-144</b> 车板小拉手LH INSIDE DOOR HANDLE LH 81626416067 TG-A XXL XLX&amp;XL</p> 
<p><b>ZC-M07-145</b> 车门外拉手RH HANDLE RH 81626416080 81626416074 81626416086 81626416078 TG-A XXL XLX&amp;XL</p> 	<p><b>ZC-M07-146</b> 车门外拉手LH HANDLE LH 81626416079 81626416075 81626416085 81626416081 TG-A XXL XLX&amp;XL</p> 	<p><b>ZC-M07-147</b> 车门外拉手锁心 KEY CYCINDER LOCK 81626416097 TG-A XXL XLX&amp;XL</p> 
<p><b>ZC-M07-148</b> 电动摇窗机RH SINDOWS REGULATOR RH 81626456053 TG-A XXL XLX&amp;XL</p> 	<p><b>ZC-M07-149</b> 电动摇窗机LH SINDOWS REGULATOR LH 81626456052 TG-A XXL XLX&amp;XL</p> 	<p><b>ZC-M07-150</b> 摇窗机电机 MOTOR 81286016143 81286016130 TG-A XXL XLX&amp;XL</p> 

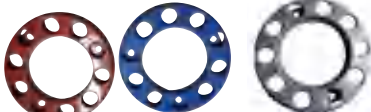

# FOR MAN TG-A XXL

















<p><b>ZC-M07-151</b>            气缸罩            ENGINE COVER            51034016014            TG-A XXL XLX&amp;XL</p> 	<p><b>ZC-M07-152</b>            护线盒            WIRE PROTECTOR ASSY            81624100073 81624100077            81254410875 81254410787            81254410656            TG-A XXL XLX&amp;XL</p> 	<p><b>ZC-M07-153</b>            空调过滤器壳            AIR FILTER SHELL            81619106041            81619420084            TG-A XXL XLX&amp;XL</p> 
<p><b>ZC-M07-154</b>            空调过滤器滤芯(466*183*80mm)            AIR INLET FILTER            81619100018 81619100029            TG-A XXL XLX&amp;XL</p> 	<p><b>ZC-M07-155</b>            面板气压弹簧81cm            SPRING FOR TOOL BOX            81970060003 81970060034            TG-A XXL XLX&amp;XL</p> 	<p><b>ZC-M07-156</b>            锁止机构            CABIN LOCK            85618516003            85618516030            TG-A XXL XLX&amp;XL</p> 
<p><b>ZC-M07-157</b>            杠中网卡子            TORSION BAR            81416850050            TG-A XXL XLX&amp;XL</p> 	<p><b>ZC-M07-158</b>            挡泥板支架            MUDGUARD BRACKET            81664200125 81904900726            81930210369 81664200068            TG-A XXL XLX&amp;XL</p> 	<p><b>ZC-M07-159</b>            挡泥板支架            MUDGUARD BRACKET            81664206080 81664206054            81664206053 81664200108            TG-A XXL XLX&amp;XL</p> 
<p><b>ZC-M07-160</b>            挡泥板支架            MUDGUARD BRACKET            81664206050 81664206084            81664206083            TG-A XXL XLX&amp;XL</p> 	<p><b>ZC-M07-161</b>            轮固罩(外径43MM*内径25MM)            HUBCAP            81459505009            TG-A XXL XLX&amp;XL</p> 	<p><b>ZC-M07-162</b>            杠支架            BUMPER INNER FRAME            81416505010            TG-A XXL XLX&amp;XL</p> 
<p><b>ZC-M07-163</b>            立柱镜            FRONT MIRROR            81637306660            TG-A XXL XLX&amp;XL</p> 	<p><b>ZC-M07-164</b>            立柱镜片            MIRROR GLASS            81637330116            TG-A XXL XLX&amp;XL</p> 	<p><b>ZC-M07-165</b>            组合开关            STALK COLUMN SWITCH            81255090139</p> 

# TG-A XXL

## FOR MAN



<p><b>ZC-M07-166</b> 车门移动模块 DOOR CONTROLLER MODULE 81258067089 81258067098</p> 	<p><b>ZC-M07-167</b> 车门移动模块 DOOR CONTROLLER MODULE 81258067097 81258067086</p> 	<p><b>ZC-M07-168</b> 遮阳罩灯 SUNVISOR LAMP 81252606099</p> 
<p><b>ZC-M07-169</b> 大灯开关 HEAD LAMP SWITCH 81255056877 81255056990 81255056932 TG-A XXL XLX&amp;XL</p> 	<p><b>ZC-M07-170</b> 大灯开关 HEAD LAMP SWITCH 8125506876 TG-A XXL XLX&amp;XL</p> 	<p><b>ZC-M07-171</b> 油底壳 OIL SUMP 51058006370 TG-A XXL XLX&amp;XL</p> 
<p><b>ZC-M07-172</b> 油底壳 OIL SUMP 51058015602 51058015726 TG-A XXL XLX&amp;XL</p> 	<p><b>ZC-M07-173</b> 油底壳 OIL SUMP 51058015726 51058015599 TG-A XXL XLX&amp;XL</p> 	<p><b>ZC-M07-174</b> 空调开关 AIR CONDITIONING SWITCH 81619906079 81619906081 81619906105 TG-A XXL XLX&amp;XL</p> 
<p><b>ZC-M07-175</b> 副水箱 AUXILIARY WATER TANK 8161976001 TG-A XXL XLX&amp;XL</p> 	<p><b>ZC-M07-176</b> 杠弯角皮圈 BUMPER RUBBER 81960010517 TG-A XXL XLX&amp;XL</p> 	<p><b>ZC-M07-177</b> 电缆入孔 CABLE HOLE 51254240009 TG-A XXL XLX&amp;XL</p> 
<p><b>ZC-M07-178</b> 机油盖 OIL FILLER CAP 51055056002 TG-A XXL XLX&amp;XL</p> 	<p><b>ZC-M07-179</b> 离合器托架 CLUTCH BRACKET 81482200152 TG-A XXL XLX&amp;XL</p> 	<p><b>ZC-M07-180</b> 波纹管 CORRUGATED PIPE 81964200517 TG-A XXL XLX&amp;XL</p> 















# FOR MAN TG-A XXL



<p><b>ZC-M07-181</b> 油底壳螺丝 OIL PAN SCREW 06080420307 06566310239 TGX TGS TGA</p> 	<p><b>ZC-M07-182</b> 油底壳密封条 OIL PAN SEALING STRIP 51059040212 TGX TGS TGA</p> 	<p><b>ZC-M07-183</b> 气缸罩密封圈 SEAL RING 51039050177 TG-A XXL XLX&amp;XL</p> 
<p><b>ZC-M07-184</b> 气缸罩螺丝 BOLT CYLINDER HEAD COVER 51962100080 TG-A XXL XLX&amp;XL</p> 	<p><b>ZC-M07-185</b> 橡胶轴承 RUBBER BUSHING 85960200004 TGX/TGS</p> 	<p><b>ZC-M07-186</b> 车门下橡胶缓冲快 RUBBER PAD 81626100036 TGX/TGS</p> 
<p><b>ZC-M07-187</b> 叶子板盖 STEPS CAP 81615100469 TGA</p> 	<p><b>ZC-M07-188</b> 立柱镜底座 FRONT MIRROR ADAPTER PLATE 81637310376 TGX TGA</p> 	<p><b>ZC-M07-189</b> 立柱镜底座皮 FRONT MIRROR ADAPTER PLATE 81637310378 TGX TGA</p> 
<p><b>ZC-M07-190</b> 油底壳固定支架 OIL PAN BRACKET 51058406008 TGX/TGS</p> 	<p><b>ZC-M07-191</b> 挡泥板护板 684x310mm MUDGUARD BOARD 684x310mm 81664100484 TG-A XXL XLX&amp;XL</p> 	<p><b>ZC-M07-192</b> 后过桥 CATWALK ALUMINUM 81429020297 81429020287 81429020269 MAN</p>  <p>104CM 42.5CM</p>
<p><b>ZC-M07-193</b> 后过桥 CATWALK ALUMINUM 81429020286 81429020292 81429020268 MAN</p>  <p>65CM 42.5CM</p>	<p><b>ZC-M07-194</b> 后扶手 HAND RAIL 81955010224 81429025333 81429025335 MAN</p> 	<p><b>ZC-M07-195</b> 后扶手 HAND RAIL 81429025335 TGX</p> 











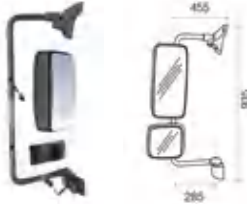



# FOR MAN TG-A XXL

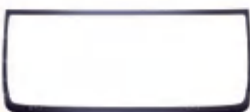

<p><b>ZC-M07-196</b> 机油盖 OIL FILTER COVER 51055050011 MAN</p> 	<p><b>ZC-M07-197</b> 面板锁止楔组装 STRIKER PLATE FRONT PANEL 81611406006 TGA / TGL</p> 	<p><b>ZC-M07-198</b> 挡泥板卡子 BRACKET METAL UPPER PART 81664100350 81664100225 81664105196 81664100233 TGA</p> 
<p><b>ZC-M07-199</b> 挡泥板盖 MUDGUARD COVER 81664400193</p> 	<p><b>ZC-M07-200</b> 保险杠亮条 CENTRAL BUMPER SHINY CHROME 81416850061 TG-A XXL XLX&amp;XL</p> 	<p><b>ZC-M07-201</b> 挡泥板护板684x260mm MUDGUARD BOARD 684x260mm 81664100483 TG-A XXL XLX&amp;XL</p> 
<p><b>ZC-M07-202</b> 波纹管 CORRUGATED PIPE 81964200519</p> 	<p><b>ZC-M07-203</b> 进气扁管连接管 INTAKE FLAT PIPE CONNECTOR 81082010491</p> 	<p><b>ZC-M07-204</b> 进气扁管连接管 INTAKE FLAT PIPE CONNECTOR 81082010490 81082010456</p> 
<p><b>ZC-M07-205</b> 油分离器 OIL SEPARATOR 51018040024 51018040025</p> 	<p><b>ZC-M07-206</b>面 板盖 PANEL COVER 81611400026</p> 	<p><b>ZC-M07-207</b> 保险杠反转支架 BUMPER REVERSE BRACKET 81412805588</p> 
<p><b>ZC-M07-208</b> 轮胎帽 WHEEL COVER MAN</p> 	<p><b>ZC-M07-209</b> 侧围外皮LH SIDE ENCLOSURE TGX LH</p> 	<p><b>ZC-M07-210</b> 侧围外皮RH SIDE ENCLOSURE TGX RH</p> 

# FOR MAN TG-A XXL













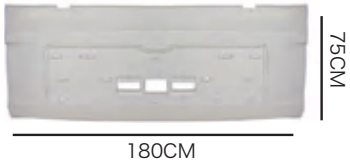

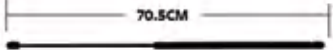

<p><b>ZC-M07-211</b> 副水壶盖 WATER TANK COVER</p> 	<p><b>ZC-M07-212</b> 倒车镜总成 LH MIRROR ASSY LH</p> 	<p><b>ZC-M07-213</b> 倒车镜总成RH MIRROR ASSY RH</p> 
<p><b>ZC-M07-214</b> 护线盖 WIRE PROTECTOR COVER 81624100073 TG-A XXL XLX&amp;XL</p> 	<p><b>ZC-M07-215</b> 护线盖 WIRE PROTECTOR COVER 81624100073 TG-A XXL XLX&amp;XL</p> 	<p><b>ZC-M07-216</b> 车门外拉手RH HANDLE RH 81626416080 81626416074 81626416086 81626416078 TG-A XXL XLX&amp;XL</p> 
<p><b>ZC-M07-217</b> 车门外拉手LH HANDLE LH 81626416079 81626416075 81626416085 81626416081 TG-A XXL XLX&amp;XL</p> 	<p><b>ZC-M07-218</b> 挡泥板支架 MUDGUARD BRACKET 81.664206130 TG-A XXL XLX&amp;XL</p> 	<p><b>ZC-M07-219</b> 挡风玻璃 WINDSHIELD 81624500078 Bredd (mm): 2052 Höjd (mm): 880 TG-A XXL XLX&amp;XL</p>  
<p><b>ZC-M07-220</b> 上车扶手 HANDLE 81970010526 TG-A LX,L&amp;M</p> 	<p><b>ZC-M07-221</b> 雨刮连杆(980CM) LINKAGE 81264116112</p> 	<p><b>ZC-M07-222</b> 机油盖 OIL CAP 51125046003</p> 
<p><b>ZC-M07-223</b> 驾驶室后工作灯 CAB REAR WORKING LIGHT 81251036060</p> 	<p><b>ZC-M07-224</b> 大倒车镜 BIG MIRROR 85637306030 81637306478</p> 	<p><b>ZC-M07-225</b> 小倒车镜 SMALL MIRROR 85637306039 565730140</p> 



# TG-A LX

## FOR MAN



<p><b>ZC-M08-001</b>            面板 PANEL            81611100063 81611100054            81611100048 81611100077            TG-A LX,L&amp;M</p> 	<p><b>ZC-M08-002</b>            面板中网            GRILLE            81611506051 81611505069            81611506049            TG-A LX,L&amp;M</p> 	<p><b>ZC-M08-003</b>            面板气压弹簧(70.5mm)            SHOCK ABSORBER(70.5mm)            81611400016            TG-A LX,L&amp;M</p> 
<p><b>ZC-M08-004</b>            杠中网            CENTRAL BUMPER            81416850052 81416850043            TG-A LX,L&amp;M</p> 	<p><b>ZC-M08-005</b>            保险杠BUMPER            81416100307 81416100308            81416100221 81416100237            TG-A LX,L&amp;M</p> 	<p><b>ZC-M08-006</b>            杠小圆盖            BUMPER COVER            81960020491            TG-A LX,L&amp;M</p> 
<p><b>ZC-M08-007</b>            杠方圆盖            BUMPER COVER            81416850037            81416850054            TG-A LX,L&amp;M</p> 	<p><b>ZC-M08-008</b> 杠            防滑条            BUMPER STEP            81416102900            TG-A LX,L&amp;M</p> 	<p><b>ZC-M08-009</b>            杠灯条RH            BUMPER END PANEL RH            81416100230            81416100312            TG-A LX,L&amp;M</p> 
<p><b>ZC-M08-010</b>            杠灯条LH            BUMPER END PANEL LH            81416100229            81416100313            TG-A LX,L&amp;M</p> 	<p><b>ZC-M08-011</b>            保险杠弯角RH            BUMPER CORNER RH            81416100226            TG-A LX,L&amp;M</p> 	<p><b>ZC-M08-012</b>            保险杠弯角LH            BUMPER CORNER LH            81416100225            TG-A LX,L&amp;M</p> 
<p><b>ZC-M08-013</b>            保险杠支架            BUMPER INNER FRAME            81416505013 81416505011            TG-A LX,L&amp;M</p> 	<p><b>ZC-M08-014</b>            遮阳罩支架            SUNVISOR MOUNTING KIT            81637350028 81637310283            TG-A LX,L&amp;M</p> 	<p><b>ZC-M08-015</b>            遮阳罩            SUNVISOR            81637010044 81637010033            TG-A LX,L&amp;M</p> 



# TG-A LX

## FOR MAN



<p><b>ZC-M08-016</b> 下脚踏板盖 STEP GARNISH COVER 81416850538 P 81416850536 G 81416850468 81416850826 G 81416850443 TG-A LX,L&amp;M</p> 	<p><b>ZC-M08-017</b> 叶 子板RH FENDER RH 81615100472 81615100470 81615100758 TG-A LX,L&amp;M</p> 	<p><b>ZC-M08-018</b> 叶 子板LH FENDER LH 81615100473 81615100471 81615100757 TG-A LX,L&amp;M</p> 
<p><b>ZC-M08-019</b> 叶子板RH FENDER RH 81615100475 81615100477 81615100478 81615100481 81615100587 81615100589 81615100591 81615100593 81615100357 TG-A LX,L&amp;M</p> 	<p><b>ZC-M08-020</b> 叶子板LH FENDER LH 81615100474 81615100476 81615100478 81615100480 81615100586 81615100588 81615100590 81615100592 81615100358 TG-A LX,L&amp;M</p> 	<p><b>ZC-M08-021</b> 叶 子板RH FENDER RH 81615100472 81615100470 81615100758 TG-A LX,L&amp;M</p> 
<p><b>ZC-M08-022</b> 叶 子板LH FENDER LH 81615100473 81615100471 81615100757 TG-A LX,L&amp;M</p> 	<p><b>ZC-M08-023</b> 叶子板RH FENDER RH 81615100582 81615100584 81615100578 81615100580 81615100492 81615100758 81615100342 TG-A LX,L&amp;M</p> 	<p><b>ZC-M08-024</b> 叶子板LH FENDER LH 81615100589 81615100587 81615100585 81615100757 81615100491 TG-A LX,L&amp;M</p> 
<p><b>ZC-M08-025</b> 叶子板RH FENDER RH 81615100472 81615100470 81615100758 TG-A LX,L&amp;M</p> 	<p><b>ZC-M08-026</b> 叶子板LH FENDER LH 81615100473 81615100471 81615100757 TG-A LX,L&amp;M</p> 	<p><b>ZC-M08-027</b> 下脚踏板(SMC)(高位)RH FOOT STEP(SMC)RH 81615100644 81615100680 81615100352 81615100742 TG-A LX,L&amp;M</p>  <p>22CM</p>
<p><b>ZC-M08-028</b> 下脚踏板(SMC)(高位)RH FOOT STEP(SMC)RH 81615100643 81615100679 81615100383 81615100741 TG-A LX,L&amp;M</p>  <p>22CM</p>	<p><b>ZC-M08-029</b> 边肚下饰板RH REAR PILLAR RH 81612100602 81615100284 TG-A LX,L&amp;M</p> 	<p><b>ZC-M08-030</b> 边肚下饰板LH REAR PILLAR LH 81612100603 81615100285 TG-A LX,L&amp;M</p> 

# TG-A LX

## FOR MAN



### ZC-M08-031

边肚下饰板RH  
REAR PILLAR RH  
81612100603 81615100285  
TG-A LX,L&M



### ZC-M08-032

边肚下饰板LH  
REAR PILLAR LH  
81612100602 81615100284  
TG-A LX,L&M



### ZC-M08-033

边肚下饰板RH  
REAR PILLAR RH  
81612100616 81615100288  
81615100346  
TG-A LX,L&M



### ZC-M08-034

边肚下饰板LH  
REAR PILLAR LH  
81612100617 81615100552  
81615100347  
TG-A LX,L&M



### ZC-M08-035

边肚下饰板RH  
REAR PILLAR RH  
81615100366 81615100368  
TG-A LX,L&M



### ZC-M08-036

边肚下饰板LH  
REAR PILLAR LH  
81615100554 81615100555  
TG-A LX,L&M



### ZC-M08-037

边肚下饰板RH  
REAR PILLAR RH  
81615100364 81615100454  
81612100726  
TG-A LX,L&M



### ZC-M08-038

边肚下饰板LH  
REAR PILLAR LH  
81615100363 81615100455  
TG-A LX,L&M



### ZC-M08-039

台阶防滑板上  
UPPER STEP  
81615100490  
TG-A LX,L&M

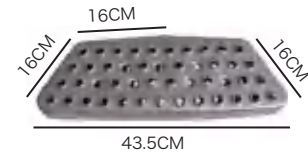

### ZC-M08-040

台阶防滑板中  
MIDDLE STEP  
81615110001 81615100421  
81615110000 81615100272  
TG-A LX,L&M

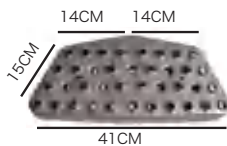

### ZC-M08-041

台阶防滑板下  
LOWER STEP  
81615105187  
TG-A LX,L&M

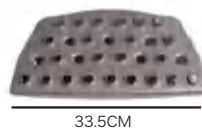

### ZC-M08-042

外A立柱RH  
FRONT PILLAR  
GARNISH RH  
81624100146  
TG-A LX,L&M



### ZC-M08-043

外A立柱LH  
FRONT PILLAR  
GARNISH LH  
81624100147  
TG-A LX,L&M



### ZC-M08-044

外A立柱RH  
FRONT PILLAR  
GARNISH RH  
81624100062  
82624100014  
TG-A LX,L&M



### ZC-M08-045

外A立柱LH  
FRONT PILLAR  
GARNISH LH  
81624100061  
82624100013  
TG-A LX,L&M



# TG-A LX

## FOR MAN



### ZC-M08-046

车门下护板RH  
DOOR PANEL RH  
81626100033  
TG-A LX,L&M



### ZC-M08-047

车门下护板LH  
DOOR PANEL LH  
81626100032  
TG-A LX,L&M



### ZC-M08-048

前轮后挡泥板RH  
FRONT MUDGUARD REAR RH  
81612100674  
82664100162  
81612100684  
TG-A LX,L&M



### ZC-M08-049

前轮后挡泥板LH  
FRONT MUDGUARD REAR LH  
81612100673  
82664100155  
81612100683  
TG-A LX,L&M



### ZC-M08-050

宽边前轮后挡泥板RH  
FRONT MUDGUARD REAR RH  
81612100684  
81612100676



### ZC-M08-051

宽边前轮后挡泥板LH  
FRONT MUDGUARD REAR LH  
81612100683  
81612100675  
TG-A LX,L&M



### ZC-M08-052

挡泥板内衬  
MUDGUARD INNER FENDER  
81612300194  
TG-A LX,L&M



### ZC-M08-053

挡泥板内衬  
MUDGUARD INNER FENDER  
81612300196  
TG-A LX,L&M



### ZC-M08-054

工具箱盖气压弹簧  
SHOCK ABSORBER(49CM)  
81970060033  
TG-A LX,L&M



### ZC-M08-055

进气扁管  
AIR INLET MESH  
81082010517  
TG-A LX,L&M



### ZC-M08-056

进气扁管配件  
AIR INLET FILTER  
TG-A LX,L&M



### ZC-M08-057

进气扁管侧盖板  
AIR INLET MESH  
81082015913  
TG-A LX,L&M



### ZC-M08-058

空气壳体  
AIR FILTER CASE  
81084006031 81084050021  
81084050017  
TG-A LX,L&M



### ZC-M08-059

进气扁管连接管  
AIR FILTER PIPE CONNECTION  
81082010538  
TG-A LX,L&M



### ZC-M08-060

空气滤芯外  
AIR FILTER  
81084050021  
TG-A LX,L&M



# TG-A LX

## FOR MAN



<p><b>ZC-M08-061</b> 空气滤芯内 AIR FILTER 81084050017 TG-A LX,L&amp;M</p> 	<p><b>ZC-M08-062</b> 空滤器卡子 AIR FILTER CLAMP 81418600040 TG-A LX,L&amp;M</p> 	<p><b>ZC-M08-063</b> 空滤器盖 AIR FILTER COVER 81083030052 TG-A LX,L&amp;M</p> 
<p><b>ZC-M08-064</b> 电瓶箱盖(小号) BATTEARY COVER 81418600144 TG-A LX,L&amp;M</p> 	<p><b>ZC-M08-065</b> 电瓶箱盖卡扣 BATTEARY CLAMP 06438090185 06438090184 06438090176 TG-A LX,L&amp;M</p> 	<p><b>ZC-M08-066</b> 杠中网卡子 TORSION BAR 81416850050 TG-A LX,L&amp;M</p> 
<p><b>ZC-M08-067</b> 工具箱盖SMC REAR PILLAR 81669120196 81669125287 81669120172 TG-A LX,L&amp;M</p> 	<p><b>ZC-M08-068</b> 工具箱盖铁 REAR PILLAR 81669125289 TG-A LX,L&amp;M</p> 	<p><b>ZC-M08-069</b> 叶子板盖 FENDER COVER 81615100469 TG-A LX,L&amp;M</p> 
<p><b>ZC-M08-070</b> 前后挡泥板支架 81612435430 81612435449 81612435421 MAN</p> 	<p><b>ZC-M08-071</b> 前办后挡泥板支架 81619306083 81619306086 TGX/TGS</p> 	<p><b>ZC-M08-072</b> 前办后挡泥板支架 85417156006 TGA XXL</p> 
<p><b>ZC-M08-073</b> 保险杠亮条 CENTRAL BUMPE SHINY CHROME TG-A LX,L&amp;M</p> 	<p><b>ZC-M08-074</b> 油箱盖 81122100015 81122100053 81122106025 81122100033 81122100040 81122100041 81122100057 81122100037 TGX TGS TGA</p> 	<p><b>ZC-M08-075</b> LED防雾灯RH FOG LAMP TGA</p> 

# TG-A LX

## FOR MAN



### ZC-M08-076

LED防雾灯LH  
FOG LAMP  
TGA



### ZC-M08-077

手动摇窗机RH  
WINDOW REGULATOR MANUAL RH  
81626456024  
TG-A XXL XLX&XL



### ZC-M08-078

手动摇窗机LH  
WINDOW REGULATOR MANUAL LH  
81626456023 81626456035  
TG-A XXL XLX&XL



### ZC-M08-079

三角滑防溜车 45\*19.5\*23cm  
WHEEL CHOCK  
81669350021  
MAN

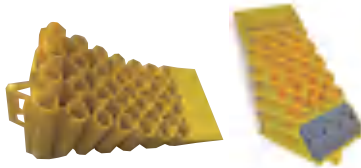

### ZC-M08-080

三角滑防溜车 45\*19.5\*23cmLH  
WHEEL CHOCK  
81669360093  
MAN



### ZC-M08-081

三角滑防溜车支架RH  
WHEEL CHOCK  
81669360092  
MAN



### ZC-M08-082

三角滑防溜车 45\*19.5\*23cm  
WHEEL CHOCK  
MAN



### ZC-M08-083

三角滑防溜车支架  
WHEEL CHOCK BRACKET  
81669360048 81669365152  
TGX TGS TGA



### ZC-M08-084 挡

泥板卡子  
81664100350  
81664100225  
TGX TGS TGA



### ZC-M08-085

边肚下饰板RH  
REAR PILLAR RH  
81612100602 81615100284  
TG-A LX,L&M



### ZC-M08-086

边肚下饰板LH  
REAR PILLAR LH  
81612100603 81615100285  
TG-A LX,L&M



### ZC-M08-087

车门护板RH  
DOOR COVER RH  
81626410113  
TG-A LX,L&M



### ZC-M08-088

车门护板LH  
DOOR COVER LH  
81626410114  
TG-A LX,L&M



### ZC-M08-089

雨刮连杆短(860CM)  
WIPER LINKAGE ASSEMBLY  
81264116113  
TGA TGX TGL



### ZC-M08-090















上车扶手  
HANDLE  
81970010525  
TG-A LX,L&M





# FOR MAN TG-L

















<p><b>ZC-M09-001</b>            面板 PANEL            81611100063 81611100054            81611100048 81611100077            TG-L</p> 	<p><b>ZC-M09-002</b>            保险杠            BUMPER            81416100309 81416100352            TG-L</p> 	<p><b>ZC-M09-003</b>            保险杠饰盖            BUMPER COVER            81416850059            TG-L</p> 
<p><b>ZC-M09-004</b>            杠小圆盖            BUMPER COVER            81416850029            TG-L</p> 	<p><b>ZC-M09-005</b>            杠边条RH            BUMPER BRACKET RH            81416100334            TG-L</p> 	<p><b>ZC-M09-006</b>            杠边条LH            BUMPER BRACKET RH            81416100333            TG-L</p> 
<p><b>ZC-M09-007</b>            叶子板RH            FENDER RH            81615100274 81615100820            TG-L</p> 	<p><b>ZC-M09-008</b>            叶子板LH            FENDER LH            81615100275 81615100821            TG-L</p> 	<p><b>ZC-M09-009</b>            叶子板RH            FENDER RH            81615100276            TG-L</p> 
<p><b>ZC-M09-010</b>            叶子板LH            FENDER LH            81615100277            TG-L</p> 	<p><b>ZC-M09-011</b> 叶            子板RH            FENDER RH            81615100562            81615100810            TG-L</p> 	<p><b>ZC-M09-012</b>            叶子板LH            FENDER LH            81615100563            81615100811            TG-L</p> 
<p><b>ZC-M09-013</b>            叶子板RH            FENDER RH            81612100368            81612100698            TG-L</p> 	<p><b>ZC-M09-014</b>            叶子板LH            FENDER LH            81612100369            81612100697            TG-L</p> 	<p><b>ZC-M09-015</b>            叶子板RH            FENDER RH            81612100382            TG-L</p> 







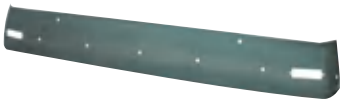









# FOR MAN TG-L



<p><b>ZC-M09-016</b> 叶子板LH FENDER LH 81612100383 TG-L</p> 	<p><b>ZC-M09-017</b> 叶子板RH FENDER RH 81612100474 TG-L</p> 	<p><b>ZC-M09-018</b> 叶子板LH FENDER LH 81612100475 TG-L</p> 
<p><b>ZC-M09-019</b> 叶子板RH FENDER RH 81612100478 TG-L</p> 	<p><b>ZC-M09-020</b> 叶子板LH FENDER LH 81612100479 TG-L</p> 	<p><b>ZC-M09-021</b> 保险杠牌照板 LICENSE PLATE 81416120018 81416120019 TG-L</p> 
<p><b>ZC-M09-022</b> 台阶防滑板 LOWER STEP 81615105187 TG-A LX,L&amp;M</p>  <p>33.5CM</p>	<p><b>ZC-M09-023</b> 前轮挡泥板RH FRONT MUDGUARD REAR RH 81664100176 TGL</p> 	<p><b>ZC-M09-024</b> 前轮挡泥板LH FRONT MUDGUARD REAR LH 81664100176 TGL</p> 
<p><b>ZC-M09-025</b> 脚踏板RH FOOR STEP RH 81615100570 81615100572 81615100862 TGL</p> 	<p><b>ZC-M09-026</b> 脚踏板LH FOOR STEP LH 81615100573 81615100575 81615100861 TGL</p> 	<p><b>ZC-M09-027</b> 前轮后挡泥板RH FRONT MUDGUARD REAR RH 81612100552 TGL</p> 
<p><b>ZC-M09-028</b> 前轮后挡泥板LH FRONT MUDGUARD REAR LH 81216100553 TGL</p> 	<p><b>ZC-M09-029</b> 电瓶盖 BATTEARY COVER 81418600083 TGL</p> 	<p><b>ZC-M09-030</b> 遮阳罩 SUNVISOR 85637010010 TGL</p> 

# FOR MAN TG-M



<p><b>ZC-M10-001</b>            面板            FRONT PANEL            81611100063 81611100054            81611100048 81611100077            TG-M</p> 	<p><b>ZC-M10-002</b>            面板中网            GRILLE            81611506051 81611505069            81611506049            TG-M</p> 	<p><b>ZC-M10-003</b>            外包角ABS RH            PANEL CORNER(OUTSIDE)RH            81624100090            TG-M</p> 
<p><b>ZC-M10-004</b>            外包角ABS LH            PANEL CORNER(OUTSIDE)LH            81624100089            TG-M</p> 	<p><b>ZC-M10-005</b>            内包角ABS RH            PANEL CORNER(INNER)RH            81624100092            TG-M</p> 	<p><b>ZC-M10-006</b>            内包角ABS LH            PANEL CORNER(INNER)LH            81624100091            TG-M</p> 
<p><b>ZC-M10-007</b>            保险杠            BUMPER            81416100359            81416100224            TG-M</p> 	<p><b>ZC-M10-008</b>            字牌            MARK            81978402089 81978402091            81978402093 81978702035            TG-M</p> 	<p><b>ZC-M10-009</b>            杠边条 RH            BUMPER BRACKET RH            81416100374 81416100356            TG-M</p> 
<p><b>ZC-M10-010</b>            杠边条 LH            BUMPER BRACKET LH            81416100373 81416100355            TG-M</p> 	<p><b>ZC-M10-011</b>            杠小圆盖            BUMPER COVER            81416850029            TG-M</p> 	<p><b>ZC-M10-012</b>            保险杠牌照板            LICENSE PLATE            8141600020            TG-M</p> 
<p><b>ZC-M10-013</b>            外包角 LH            PANEL CORNER(OUTSIDE) LH            81624100185            TG-M</p> 	<p><b>ZC-M10-014</b>            外包角 RH            PANEL CORNER(OUTSIDE) RH            81624100186            TG-M</p> 	<p><b>ZC-M10-015</b>            内包角 LH            PANEL CORNER(INNER) LH            81624100187            TG-M</p> 

# TG-M

## FOR MAN



### ZC-M10-016

内包角 RH  
PANEL CORNER(INNER) RH  
81624100188  
TG-M



### ZC-M10-017

大灯框 LH  
HEAD LAMP COVER LH  
81251400143  
TG-M



### ZC-M10-018

大灯框 RH  
HEAD LAMP COVER RH  
81251400142  
TG-M



### ZC-M10-019

叶子板RH  
FENDER RH  
81615100652  
TG-M



### ZC-M10-020

叶子板LH  
FENDER LH  
81615100651  
TG-M



### ZC-M10-021

脚踏板RH  
FOOR STEP RH  
81615100682  
81615100864  
TG-M



### ZC-M10-022

脚踏板LH  
FOOR STEP LH  
81615100681  
81615100863  
TG-M



### ZC-M10-023

边肚下饰板RH  
REAR PILLAR LOWER RH  
81612100657  
81612100505  
TG-M



### ZC-M10-024

边肚下饰板LH  
REAR PILLAR LOWER LH  
81612100658  
81612100504  
TG-M



### ZC-M10-025

边肚下饰板RH  
REAR PILLAR LOWER RH  
81612100496  
TG-M



### ZC-M10-026

边肚下饰板LH  
REAR PILLAR LOWER LH  
81612100497  
TG-M



### ZC-M10-027

装饰板RH  
PANELING RH  
81416140042  
81416140004  
TG-M



### ZC-M10-028

装饰板LH  
PANELING LH  
81416140043  
81416140005  
TG-M



### ZC-M10-029

保险杠下饰条RH  
TRIM(BUMPER) RH  
81416140021  
81416140001  
81416140003  
TG-M



### ZC-M10-030

保险杠下饰条RH  
TRIM(BUMPER) RH  
81416140022  
81416140000  
81416140002  
TG-M



# TG-M FOR MAN



<p><b>ZC-M10-031</b> 面板 PANEL 8161110084 TG-M</p> 	<p><b>ZC-M10-032</b> 副水箱 WAQTER TANK 81061026115 TG-M</p> 	<p><b>ZC-M10-033</b> 保险杠 BUMPER 85416104031 85416104016 TG-M</p> 
<p><b>ZC-M10-034</b> 雨刮水箱 WATER CONTAINER 81264810074 TGM TGL</p> 	<p><b>ZC-M10-035</b> 副水壶连接管 FILTER TUBE 81264810078 MAN TGM</p> 	<p><b>ZC-M10-036</b> 付水箱 EXPANSION TANK 81061026228 81061026213 TGM TGL</p> 
<p><b>ZC-M10-037</b> 台价加长板 FOOTBOARD 81615100687 81615100807 MAN TGM</p> 	<p><b>ZC-M10-038</b> 台价加长板 FOOTBOARD 81615100688 81615100808 MAN TGM</p> 	<p><b>ZC-M10-039</b> 后灯左 TAIL LAMP LH</p> 
<p><b>ZC-M10-040</b> 后灯右 TAIL LAMP RH</p> 	<p><b>ZC-M10-041</b> 后灯罩 TAIL LAMP CASE</p> 	<p><b>ZC-M10-042</b> 倒车镜支架盖LH MIRROR ARM WITH WIRE AND BASE LH 81637316557 TG-A XXL XLX&amp;XL</p> 
<p><b>ZC-M10-043</b> 倒车镜支架盖RH MIRROR ARM WITH WIRE AND BASE RH 81637316556 TG-A XXL XLX&amp;XL</p> 	<p><b>ZC-M10-044</b> 雨刮连杆(790 CM) LINKAGE 81264116111</p> 	<p><b>ZC-M10-045</b> 镜杆 MIRROR BRCKET 81637306527</p> 

# F2000











## FOR MAN



# F2000

## FOR MAN



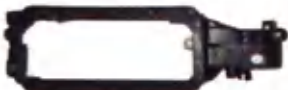













<p><b>ZC-M11-016</b>            花纹大灯角灯RH            CORNER LAMP RH            81252290832 81253206084            F2000</p> 	<p><b>ZC-M11-017</b>            花纹大灯角灯LH            CORNER LAMP LH            81252290832 81253206084            F2000</p> 	<p><b>ZC-M11-018</b>            花纹大灯玻璃RH            HEAD LAMP GLASS RH            81251100068            F2000</p> 
<p><b>ZC-M11-019</b>            花纹大灯玻璃LH            HEAD LAMP GLASS LH            81251100067            F2000</p> 	<p><b>ZC-M11-020</b>            保险杠小圆盖            BUMPER COVER            81061026113            F2000</p> 	<p><b>ZC-M11-021</b>            遮阳罩            SUNVISOR            81637010021 81637010010            83637010504            F2000</p> 
<p><b>ZC-M11-022</b>            遮阳罩支架RH            SUNVISOR BRACKET RH            81637010022            F2000</p> 	<p><b>ZC-M11-023</b>            遮阳罩支架LH            SUNVISOR BRACKET LH            81637010023            F2000</p> 	<p><b>ZC-M11-024</b>            遮阳罩灯            SUNVISOR LAMP            81252606039 81252606040            F2000</p> 
<p><b>ZC-M11-025</b>            遮阳罩支架            SUNVISOR SUPPORT            81637350025            F2000</p> 	<p><b>ZC-M11-026</b> 花            纹防雾灯RH            FOG LAMP RH            81251016338            F2000</p> 	<p><b>ZC-M11-027</b> 花            纹防雾灯LH            FOG LAMP LH            81251016339            F2000</p> 
<p><b>ZC-M11-028</b>            雾灯支架            FOG LAMP HOLDER            81416135035            F2000</p> 	<p><b>ZC-M11-029</b>            防雾灯防滑板            BUMPER LOW STEP            81416155061            F2000</p> 	<p><b>ZC-M11-030</b>            雾灯后框RH            FOG LAMP CASE RH            81251150022            F2000</p> 



# F2000

## FOR MAN

















<p><b>ZC-M11-031</b>            雾灯后框LH            FOG LAMP CASE LH            81251150023            F2000</p> 	<p><b>ZC-M11-032</b>            高副保险杠190mm            BUMPER(190mm)            81416130074            F2000</p> 	<p><b>ZC-M11-033</b>            高副保险杠弯角RH            BUMPER CORNER RH            81416130076            F2000</p> 
<p><b>ZC-M11-034</b>            高副保险杠弯角LH            BUMPER CORNER LH            81416130077            F2000</p> 	<p><b>ZC-M11-035</b>            中副保险杠弯角RH            BUMPER CORNER RH            81416130078            F2000</p> 	<p><b>ZC-M11-036</b>            中副保险杠弯角LH            BUMPER CORNER LH            81416130079            F2000</p> 
<p><b>ZC-M11-037</b>            低副保险杠弯角RH            BUMPER CORNER RH            81416130081            F2000</p> 	<p><b>ZC-M11-038</b>            低副保险杠弯角LH            BUMPER CORNER LH            81416130080            F2000</p> 	<p><b>ZC-M11-039</b>            中副保险杠250mm            BUMPER(250mm)            81416130073            F2000</p> 
<p><b>ZC-M11-040</b>            低副保险杠350mm            BUMPER(350mm)            81416130071            F2000</p> 	<p><b>ZC-M11-041</b>            副保险杠雾灯盖RH            FOG LAMP COVER RH            81416130066            F2000</p> 	<p><b>ZC-M11-042</b>            副保险杠雾灯盖LH            FOG LAMP COVER LH            81416130069            F2000</p> 
<p><b>ZC-M11-043</b> 叶            子板RH            FNEDER RH            81612105364            F2000</p> 	<p><b>ZC-M11-044</b> 叶            子板LH            FNEDER LH            81612105363            F2000</p> 	<p><b>ZC-M11-045</b>            低位脚踏板RH            STEP RUBBER RH            81615100230            F2000</p> 

# F2000

## FOR MAN



<p><b>ZC-M11-046</b> 低位脚踏板LH STEP RUBBER LH 81615100229 F2000</p>  <p>85cm</p>	<p><b>ZC-M11-047</b> 低位上车栏板RH FRONT PILLAR STRIP(M/L)RH 81615105164 F2000</p>  <p>55cm</p>	<p><b>ZC-M11-048</b> 低位上车栏板LH FRONT PILLAR STRIP(M/L)LH 81615105163 F2000</p>  <p>55cm</p>
<p><b>ZC-M11-049</b> 高位脚踏板RH STEP RUBBER RH 81615100226 F2000</p>  <p>72cm</p>	<p><b>ZC-M11-050</b> 高位脚踏板LH STEP RUBBER LH 81615100225 F2000</p>  <p>72cm</p>	<p><b>ZC-M11-051</b> 高位上车栏板RH FRONT PILLAR STRIP(H)RH 81615105162 F2000</p>  <p>59cm</p>
<p><b>ZC-M11-052</b> 高位上车栏板LH FRONT PILLAR STRIP(H)LH 81615105161 F2000</p>  <p>59cm</p>	<p><b>ZC-M11-053</b> 台阶上防滑板RH STEP RH 81615100268 F2000</p> 	<p><b>ZC-M11-054</b> 台 阶上防滑板LH STEP LH 81615100267 F2000</p> 
<p><b>ZC-M11-055</b> 台阶中防滑板RH STEP RH 81615100262 F2000</p> 	<p><b>ZC-M11-056</b> 台 阶中防滑板LH STEP LH 81615100263 F2000</p> 	<p><b>ZC-M11-057</b> 台阶下防滑板RH STEP RH 81615105196 F2000</p> 
<p><b>ZC-M11-058</b> 台 阶下防滑板LH STEP LH 81615105197 F2000</p> 	<p><b>ZC-M11-059</b> 低 位台阶防滑板 STEP 81615105181 F2000</p> 	<p><b>ZC-M11-060</b> 面板 PANEL 81611100043 81611100044 F2000</p> <p>217cm</p> 

# F2000

## FOR MAN

















<p><b>ZC-M11-061</b> 面 板中网 PANEL GRILLE 81611505060 F2000</p> 	<p><b>ZC-M11-062</b> 面板气压弹簧(74mm) SHOCK ABSORBER(74mm) 81748210095 F2000</p> <p style="text-align: center;">74mm</p> 	<p><b>ZC-M11-063</b> 字牌 MARK 81978400314 81978400315 81978400316 81978700114 F2000</p> 
<p><b>ZC-M11-064</b> 外包角RH PANEL CORNER(SMC) RH 81624102224 81624102250 F2000</p> 	<p><b>ZC-M11-065</b> 外包角LH PANEL CORNER(SMC) LH 81624102225 81624102251 F2000</p> 	<p><b>ZC-M11-066</b> 外包角长(SMC)RH PANEL CORNER(SMC) RH 81624100064 81624100066 F2000</p> <p style="text-align: center;">68cm</p> 
<p><b>ZC-M11-067</b> 外包角长(SMC)LH PANEL CORNER (SMC)LH 81624100063 81624100065 F2000</p> <p style="text-align: center;">68cm</p> 	<p><b>ZC-M11-068</b> 外包角短(SMC)RH PANEL CORNER RH 81624100020 F2000</p> <p style="text-align: center;">48cm</p> 	<p><b>ZC-M11-069</b> 外包角短(SMC)LH PANEL CORNER LH 81624100019 F2000</p> <p style="text-align: center;">48cm</p> 
<p><b>ZC-M11-070</b> 倒车镜支架RH MIRROR ARM RH 81637316490 81637316320 81637316502 F2000</p> 	<p><b>ZC-M11-071</b> 倒车镜支架LH MIRROR ARM LH 81637316489 81637316321 81637316503 F2000</p> 	<p><b>ZC-M11-072</b> 倒车镜支架盖RH MIRROR HOLDER CAP RH 85637100010 85637100004 F2000</p> 
<p><b>ZC-M11-073</b> 倒车镜支架盖LH MIRROR HOLDER CAP LH 85637100009 85637100003 F2000</p> 	<p><b>ZC-M11-074</b> 大倒车镜RH MIRROR BIG RH 81637306316 81637306368 F2000</p> 	<p><b>ZC-M11-075</b> 大倒车镜LH MIRROR BIG LH 81637306315 81637306367 F2000</p> 

# F2000

## FOR MAN

















<p><b>ZC-M11-076</b> 小倒车镜 MIRROR SAMLL 81617306317 81617306308 81617306328 81617306026 81617306025 81617306327 F2000</p> 	<p><b>ZC-M11-077</b> 车门镜 DOOR MIRROR 81637306294 81637306033 F2000</p> 	<p><b>ZC-M11-078</b> 过滤器壳 AIR FILTER CASE 81619506043 F2000</p> 
<p><b>ZC-M11-079</b> 空 气滤芯 AIR FILTER 81083040094 82083040097 F2000</p> 	<p><b>ZC-M11-080</b> 空气滤盖 AIR FILTER COVER 81084006005 F2000</p> 	<p><b>ZC-M11-081</b> 空滤器总成 AIR FILTER COVER 81083036051 F2000</p> 
<p><b>ZC-M11-082</b> 空滤卡子 AIR FILTER CLAMP 83083400005 F2000</p> 	<p><b>ZC-M11-083</b> 空滤器总成 AIR FILTER ASSEMBLY 81084006006 F2000</p> 	<p><b>ZC-M11-084</b> 进气扁管连接管 AIR INTAKE CONNECTOR 81082010308 F2000</p> 
<p><b>ZC-M11-085</b> 进气扁管连接管皮 AIR FILTER PIPE 81082010306 F2000</p> 	<p><b>ZC-M11-086</b> 前轮后挡泥板RH FRONT MUDGUARD REAR RH 81664100352 81664105080 F2000</p> 	<p><b>ZC-M11-087</b> 前轮后挡泥板LH FRONT MUDGUARD REAR LH 81664100353 81664105081 F2000</p> 
<p><b>ZC-M11-088</b> 挡泥板内衬RH FRONT MUDGUARD UPPER RH 81612300066 F2000</p> 	<p><b>ZC-M11-089</b> 挡泥板内衬RH FRONT MUDGUARD UPPER LH 81612300067 F2000</p> 	<p><b>ZC-M11-090</b> 挡 泥板灯 SIDE LAMP 81252606104 F2000</p> 

# F2000

## FOR MAN

















<p><b>ZC-M11-091</b> 进气扁管 AIR INLET PIPE 81082016028 F2000</p> 	<p><b>ZC-M11-092</b> 进 气扁管 AIR INLET 81082016053 F2000</p> 	<p><b>ZC-M11-093</b> 电瓶箱盖 BATTEARY COVER 81418600058 81418600069 F2000</p> 
<p><b>ZC-M11-094</b> 消 声器 MUFFLER 81151010316 F2000</p> 	<p><b>ZC-M11-095</b> 后轮大半圆挡泥板 MUDGUARD 81664100086 F2000</p> 	<p><b>ZC-M11-096</b> 挡 泥板灯 SIDE LAMP 81429500071 F2000</p> 
<p><b>ZC-M11-097</b> 进气扁管连接接管 AIR INLET PIPE 81082010358 F2000</p> 	<p><b>ZC-M11-098</b> 进气扁管连接接管 AIR INLET PIPE DZ9118190190 F2000</p> 	<p><b>ZC-M11-099</b> M窗框RH DOOR FRAME RH 81626300048 F2000</p> 
<p><b>ZC-M11-100</b> M窗框LH DOOR FRAME LH 81626300047 F2000</p> 	<p><b>ZC-M11-101</b> 车门板RH DOOR TRIM RH 81626306020 F2000</p> 	<p><b>ZC-M11-102</b> 车门板LH DOOR TRIM LH 81626306021 F2000</p> 
<p><b>ZC-M11-103</b> 车门板大拉手 DOOR INSIDE HANDLE COVER 81626410101 F2000</p> 	<p><b>ZC-M11-104</b> 车门板小拉手RH DOOR OUTSIDE HANDLE RH 81626410100 F2000</p> 	<p><b>ZC-M11-105</b> 车门板小拉手LH DOOR OUTSIDE HANDLE LH 81626410099 F2000</p> 

# F2000

## FOR MAN

















<p><b>ZC-M11-106</b>            车门升降机(带电机)RH            WINDOWS REGULATOR(ELECTRIC)RH            81626406050            F2000</p> 	<p><b>ZC-M11-107</b>            车门升降机(带电机)LH            WINDOWS REGULATOR(ELECTRIC)LH            81626406049            F2000</p> 	<p><b>ZC-M11-108</b>            车门升降机(不带电机)RH            WINDOWS REGULATOR RH            81626406052 81626406044            81626406035            F2000</p> 
<p><b>ZC-M11-109</b>            车门升降机(不带电机)LH            WINDOWS REGULATOR LH            81626406051 81626406043            81626406034            F2000</p> 	<p><b>ZC-M11-110</b>            车门工具箱RH            DOOR TOOL BOX RH            81637450016            F2000</p> 	<p><b>ZC-M11-111</b>            车门工具箱LH            DOOR TOOL BOX LH            81637450017            F2000</p> 
<p><b>ZC-M11-112</b>            扶手总成            HANDLE ASSEMBLY            81970016069            F2000</p> 	<p><b>ZC-M11-113</b>            玻璃摇把            REGULATOR HANDLE            81626416052            F2000</p> 	<p><b>ZC-M11-114</b>            车门内衬板下RH            DOOR TRIM RH            81626305094            F2000</p> 
<p><b>ZC-M11-115</b>            车门内衬板下LH            DOOR TRIM LH            81626305095            F2000</p> 	<p><b>ZC-M11-116</b>            车门总成RH            DOOR COMPLETELY RH            81626006238            F2000</p> 	<p><b>ZC-M11-117</b>            车门总成LH            DOOR COMPLETELY LH            81626006237            F2000</p> 
<p><b>ZC-M11-118</b>            车门壳RH            DOOR SHELL RH            81626004082            81626004078            F2000</p> 	<p><b>ZC-M11-119</b>            车门壳LH            DOOR SHELL LH            81626004087            81626004077            F2000</p> 	<p><b>ZC-M11-120</b> 杯            托架            CUP HOLDER            81637450015            F2000</p> 



# F2000















## FOR MAN



<p><b>ZC-M11-121 护</b> 风圈外 FAN SHROUD 81066200109 81066200158 81066200137 F2000</p> 	<p><b>ZC-M11-122 护</b> 风圈内 FAN SHROUD 81066200110 81066200135 F2000</p> 	<p><b>ZC-M11-123</b> 前翻转支架 FRONT BRACKET 81417156010 F2000</p> 
<p><b>ZC-M11-124</b> 叶子板长条短RH FENDER RH 81612100162 F2000</p> 	<p><b>ZC-M11-125 叶</b> 子板长条短LH FENDER LH 81612100163 F2000</p> 	<p><b>ZC-M11-126 工</b> 具箱RH TOOL BOX RH 81669120034 F2000</p> 
<p><b>ZC-M11-127 工</b> 具箱LH TOOL BOX LH 81669120033 F2000</p> 	<p><b>ZC-M11-128</b> 叶子板长条长RH FENDER RH 81612100172 F2000</p> 	<p><b>ZC-M11-129</b> 叶子板长条长LH FENDERLH 81612100173 F2000</p> 
<p><b>ZC-M11-130</b> 雨刮支架 WIPER COVER ASSY(STEEL) 81624105031 F2000</p> 	<p><b>ZC-M11-131 面</b> 板拉手 HANDLE 81970015082 81970015081 F2000</p> 	<p><b>ZC-M11-132</b> 后蓄雨刮水箱 REAR WIPER TANK 81264810636 F2000</p> 
<p><b>ZC-M11-133</b> 后蓄雨刮水箱盖 SPRAY THE LID 81264810026 F2000</p> 	<p><b>ZC-M11-134</b> 后蓄雨刮水箱电机 REAR WIPER TANK MOTOR 81264856030 F2000</p> 	<p><b>ZC-M11-135</b> 膨胀水箱 EXPANSION THAK 81061026118 F2000</p> 

# F2000 FOR MAN



<p><b>ZC-M11-136</b> 膨胀水箱(螺丝2个出水口) WATER TANK 81061026201 81061026098 F2000</p> 	<p><b>ZC-M11-137</b> 膨胀水箱盖 CYLINDER HEAD COVER 81061110018 F2000</p> 	<p><b>ZC-M11-138</b> 膨胀水箱盖 CYLINDER HEAD COVER 81061110020 F2000</p> 
<p><b>ZC-M11-139</b> 锁 止机构 CABIN LOCK 81618516020 F2000</p> 	<p><b>ZC-M11-140</b> 外拉手 DOOR OUTSIDE HANDLE 81971006079 81971006099 81971006038 81971006050 F2000</p> 	<p><b>ZC-M11-141</b> 杠支架 UPPER SUPPORT BUMPER 81416015044 F2000</p> 
<p><b>ZC-M11-142</b> 面板合叶 PANEL BRACKET 81624400031 F2000</p> 	<p><b>ZC-M11-143</b> 面板合叶垫片 PANEL BRACKET 81624400022 F2000</p> 	<p><b>ZC-M11-144</b> 车 门锁块 DOOR LOCK 81626800055 F2000</p> 
<p><b>ZC-M11-145</b> 车门锁块RH DOOR LOCK RH 81626806096 F2000</p> 	<p><b>ZC-M11-146</b> 车门锁块LH DOOR LOCK LH 81626806095 F2000</p> 	<p><b>ZC-M11-147</b> 门锁总成RH DOOR LOCK ASSY RH 81626806108 F2000</p> 
<p><b>ZC-M11-148</b> 门锁总成LH DOOR LOCK ASSY LH 81626806107 F2000</p> 	<p><b>ZC-M11-149</b> 车门限位器 DOOR CHECK STRAP 81626706011 81626910010 81626925001 F2000</p> 	<p><b>ZC-M11-150</b> 雨刮电机 WIPER MOTOR 81264016119 F2000</p> 

# F2000

## FOR MAN



### ZC-M11-151

点火开关  
IGNITION SWITCH  
81464336009  
F2000



### ZC-M11-152

组合开关  
COMBINATION SWITCH  
81355090093  
F2000



### ZC-M11-153

后悬置支架RH  
REAR BRACKET RH  
81417015344 81417015348  
F2000



### ZC-M11-154

后悬置支架LH  
REAR BRACKET LH  
81417015345 81417015347  
F2000



### ZC-M11-155

驾驶室前减震  
FRONT SHOCK ABSORBER  
81417226013  
F2000



### ZC-M11-156

驾驶室后减震  
REAR SHOCK ABSORBER  
81417226012  
F2000



### ZC-M11-157

前围  
FRONT PUTSIDE  
FRAME ASSY(STEEL)  
81624105100  
F2000



### ZC-M11-158

底板  
UNDER BOARD  
82628115005  
F2000



### ZC-M11-159

半高顶驾驶室壳体  
CABIN SHEET  
DZ0163100101  
F2000



### ZC-M11-160

后围  
REAR FRAME ASSY  
81627104235  
F2000



### ZC-M11-161

侧围RH  
WINDOWS REALL PILLAR RH  
81625104500  
F2000



### ZC-M11-162

侧围LH  
WINDOWS REALL PILLAR LH  
81625104503  
F2000



### ZC-M11-163

后灯RH  
TAIL LAMP RH  
DZ9200810020  
81252256523  
F2000



### ZC-M11-164

后灯LH  
TAIL LAMP LH  
DZ9200810019  
81252256524  
F2000

















### ZC-M11-165 机

油盖  
OIL CAP  
51125046003  
51125046006  
F2000



# F2000 FOR MAN



<p><b>ZC-M11-166</b> 机 油盖 OIL CAP 51055056002 51055057001 F2000</p> 	<p><b>ZC-M11-167</b> 挡泥板卡子 MUDGUARD CLIP F2000</p> 	<p><b>ZC-M11-168</b> 水 晶防雾灯RH FOG LAMP RH 81251016338 F2000</p> 
<p><b>ZC-M11-169</b> 水 晶防雾灯LH FOG LAMP LH 81251016339 F2000</p> 	<p><b>ZC-M11-170</b> 中网卡扣 PANEL CLIP 81925010029 F2000</p> 	<p><b>ZC-M11-171</b> 上 车扶手 HANDLE 81970016065 F2000</p> 
<p><b>ZC-M11-172</b> 膨胀水箱(1个出水口) EXPENSION TANK 81061026209 81061026205 F2000</p> 	<p><b>ZC-M11-173</b> 进气扁管连接管 AIR INTAKE CONNECTION DZ9112196032 F2000</p> 	<p><b>ZC-M11-174</b> 进气扁管连接管 AIR INTAKE CONNECTION DZ91121290600 F2000</p> 
<p><b>ZC-M11-175</b> 手动摇窗机RH WINDOW REGULATOR RH 81626406058 F2000</p> 	<p><b>ZC-M11-176</b> 手动摇窗机LH WINDOW REGULATOR LH 81626406057 F2000</p> 	<p><b>ZC-M11-177</b> 护线盒 WIRE PROTECTION 81254256002 F2000</p> 
<p><b>ZC-M11-178</b> 后轮后小半圆 REAR WHEEL MUDGUARD 81664100101 F2000</p> 	<p><b>ZC-M11-179</b> 后轮后小半圆卡扣 BRACKET CLIP 81974010857 F2000</p> 	<p><b>ZC-M11-180</b> 左水壶盖板 WATER TANK COVER 81662700002 F2000</p> 

# F2000

## FOR MAN



### ZC-M11-181 天

窗  
WINDOW  
81629416038  
F2000



### ZC-M11-182

天窗护框  
WINDOW BOARD  
F2000



### ZC-M11-183

后轮后大半圆  
REAR MUDGUARD  
F2000



### ZC-M11-184

后轮后大半圆  
REAR MUDGUARD  
F2000



### ZC-M11-185

轮固罩(外径43mm\*内径25mm)  
HUBCAP  
81459505009  
F2000



### ZC-M11-186

膨胀水箱  
XXPANSION TANK  
DZ9114530260  
F2000



### ZC-M11-187

挂挡杆皮  
ROD SKIN  
819642000324  
F2000



### ZC-M11-188 换

挡杆橡胶座  
GEAR COVER  
81326706184  
F2000



### ZC-M11-189 地

板压条  
FLOOR STRIPE  
81615100137  
F2000



### ZC-M11-190 雨

刮臂  
WIPER ARM  
81264300116  
F2000



### ZC-M11-191 雨

刮片  
WIPER BLADE  
81264400067  
F2000



### ZC-M11-192

空气滤清器配件  
AIR CLEANER PARTS  
81083120010  
F2000



### ZC-M11-193

半高顶驾驶室总成  
CABIN ASSY  
F2000



### ZC-M11-194

离合器总泵  
CLUTCH MASTER CYLINDER  
DZ9114230022  
F2000



### ZC-M11-195

雨刮继电器  
WIPER FLASHER RELAY  
81253110023  
F2000



# F2000

## FOR MAN



<p><b>ZC-M11-196</b> 闪光继电器 FLASHER RELAY 81253110006 F2000</p> 	<p><b>ZC-M11-197</b> 转向传动轴总成 STEERING DRIVE SHAFT ASSEMBLY 81461226112 F2000</p> 	<p><b>ZC-M11-198</b> 电控暖风单元 ELECTRIC HEATER UNIT 81259356706 F2000</p> 
<p><b>ZC-M11-199</b> 阅读灯 READING LAMP 81252026006 F2000</p> 	<p><b>ZC-M11-200</b> 轮胎盖螺丝 TIRE COVER SCREW 81443120009 F2000</p>  	<p><b>ZC-M11-201</b>门 拉手总成 HANDLE ASSY 81626806108 81626806107 F2000</p> 
<p><b>ZC-M11-202</b> 膨胀水箱 EXPENSION TANK 81061026219 F2000</p> 	<p><b>ZC-M11-203</b> 挡泥皮 MUDGUARD F2000</p> 	<p><b>ZC-M11-204</b> 保险杠铁 BUMPER IRON</p> 
<p><b>ZC-M11-205</b> 保险杠连体铁 BUMPER INTEGRATED IRON</p> 		



**FOR MAN**













**M2000/L2000/LE2000**



<p><b>ZC-M12-001</b>          保险杠          BUMPER          85416104002 85416104003          85416104004          M2000</p> 	<p><b>ZC-M12-002</b>          保险杠          BUMPER          85416104002 85416104003          85416104004          L2000/LE2000</p> 	<p><b>ZC-M12-003</b>          上脚踏板RH          UPPER STEP RH          85612100004          M2000/L2000/LE2000</p> 
<p><b>ZC-M12-004</b>          上脚踏板RH          UPPER STEP RH          85612100003          M2000/L2000/LE2000</p> 	<p><b>ZC-M12-005</b>          包角RH          PANEL CORNER RH          85611100036          M2000/L2000/LE2000</p> 	<p><b>ZC-M12-006</b>          包角LH          PANEL CORNER LH          85611100035          M2000/L2000/LE2000</p> 
<p><b>ZC-M12-007</b>          挡泥板RH          MUDGUARD RH          85612300028          M2000/L2000/LE2000</p> 	<p><b>ZC-M12-008</b>          挡泥板LH          MUDGUARD LH          85612300025          M2000/L2000/LE2000</p> 	<p><b>ZC-M12-009</b>          挡泥板RH          MUDGUARD RH          85612100020          M2000/L2000/LE2000</p> 
<p><b>ZC-M12-010</b>          挡泥板LH          MUDGUARD LH          85612100019          M2000/L2000/LE2000</p> 	<p><b>ZC-M12-011</b>          挡泥板RH          MUDGUARD RH          85612100008          M2000/L2000/LE2000</p> 	<p><b>ZC-M12-012</b>          挡泥板LH          MUDGUARD LH          85612100007          M2000/L2000/LE2000</p> 
<p><b>ZC-M12-013</b>          角灯RH          CORNER LAMP RH          M2000/L2000/LE2000</p> 	<p><b>ZC-M12-014</b>          角灯LH          CORNER LAMP LH          M2000/L2000/LE2000</p> 	<p><b>ZC-M12-015</b>          面板中网          GRILLE          85611505002          LE2000</p> 

# FOR MAN M2000/L2000/LE2000



<p><b>ZC-M12-016</b> 保险杠 BUMPER 85416104012 LE2000</p> 	<p><b>ZC-M12-017</b> 保险杠牌照板 LICENSE PLATE 85416104013 LE2000</p> 	<p><b>ZC-M12-018</b> 保险杠 BUMPER 85416104031 85416104016 LE2000</p> 
<p><b>ZC-M12-019</b> 面板 PANEL 85611100040 LE2000</p> 	<p><b>ZC-M12-020</b> 遮阳板 SUNVISOR 85637010010 LE2000</p> 	<p><b>ZC-M12-021</b> 保险杠灯条 RH BUMPER END PANEL RH 85416100008 LE2000</p> 
<p><b>ZC-M12-022</b> 保险杠灯条 LH BUMPER END PANEL LH 85416100007 LE2000</p> 	<p><b>ZC-M12-023</b> 上脚踏板RH FOOTSTEP RH 85612100126 85612100090 LE2000</p> 	<p><b>ZC-M12-024</b> 上脚踏板LH FOOTSTEP LH 85612100125 85612100089 LE2000</p> 
<p><b>ZC-M12-025</b> 保险杠灯 SIDE LAMP 81253206100 LE2000</p> 	<p><b>ZC-M12-026</b> 电瓶箱盖 BATTERY COVER 81418600083 LE2000</p> 	<p><b>ZC-M12-027</b> 保险杠上饰板RH BUMPER UPPER GARNISH RH 85611100018</p> 
<p><b>ZC-M12-028</b> 保险杠上饰板LH BUMPER UPPER GARNISH LH 85611100017</p> 		

# M90/F90/F2000 TRACTORS FOR MAN



<p><b>ZC-M13-001</b> 保险杠 BUMPER 81416104067 M 90/F 90</p> 	<p><b>ZC-M13-002</b> 保险杠 BUMPER 81416104066 M 90/F 90</p> <p><b>WITHOUT HOLES</b></p> 	<p><b>ZC-M13-003</b> 保险杠 BUMPER 81416104071 M 90/F 90</p> <p><b>WITH 2 HOLES</b></p> 
<p><b>ZC-M13-004</b> 保险杠 BUMPER 81416104072 M 90/F 90</p> <p><b>WITH 4 HOLES</b></p> 	<p><b>ZC-M13-005</b> 副杠 SPOILER 81416130014 81416130015 M 90/F 90</p> 	<p><b>ZC-M13-006</b> 副杠 SPOILER 81416130018 81416130019 M 90/F 90</p> 
<p><b>ZC-M13-007</b> 副杠 SPOILER 81416130020 81416130021 M 90/F 90</p> 	<p><b>ZC-M13-008</b> 大灯RH HEAD LAMP RH 81251016218 M 90/F 90</p> 	<p><b>ZC-M13-009</b> 大灯LH HEAD LAMP LH 81251016219 M 90/F 90</p> 
<p><b>ZC-M13-010</b> 角灯RH CORNER LAMP RH 81253206078 M 90/F 90</p> 	<p><b>ZC-M13-011</b> 角灯LH CORNER LAMP LH 81253206077 M 90/F 90</p> 	<p><b>ZC-M13-012</b> 台阶RH STEP RUBBER RH 81615100130 M 90/F 90</p> <p>58.5CM</p> 
<p><b>ZC-M13-013</b> 台阶LH STEP RUBBER LH 81615100129 M 90/F 90</p> <p>58.5CM</p> 	<p><b>ZC-M13-014</b> 上车拦板RH STAND PANEL GARNISH RH 81612105310 M 90/F 90</p> <p>17.88 cm 18.12</p> 	<p><b>ZC-M13-015</b> 上车拦板LH STAND PANEL GARNISH LH 81612105311 M 90/F 90</p> <p>17.88 cm 18.12</p> 

# M90/F90/F2000 TRACTORS

## FOR MAN



### ZC-M13-016

水箱  
WATER TANK  
81061026112  
M 90/F 90



### ZC-M13-017

遮阳板  
SUNVISOR  
81637010010



### ZC-M13-018

遮阳板支架  
SUNVISOR BRACKET  
81637350024



### ZC-M13-019

换挡手柄(2孔)  
GEAR SHIFT KNOB  
81970106011



### ZC-M13-020

换挡手柄(3孔)  
GEAR SHIFT KNOB  
81970106013



### ZC-M13-021

换挡手柄(右驾)  
GEAR SHIFT KNOB  
81970106010  
(FOR RH DRIVE)



### ZC-M13-022

脚踏板  
STEP  
81612100161



### ZC-M13-023

脚踏板RH  
STEP RH  
81615105118



### ZC-M13-024

脚踏板LH  
STEP LH  
81615105117



### ZC-M13-025

工程车铁杠中  
CENTER BUMPER  
81416105376  
F2000 6X4 - 8X4



### ZC-M13-026

工程车铁杠RH  
FRONT BUMPER RH  
81416105378 81416105454  
F2000 6X4 - 8X4



### ZC-M13-027

工程车铁杠LH  
FRONT BUMPER LH  
81416105377 81416105453  
F2000 6X4 - 8X4



### ZC-M13-028

工程车叶子板RH  
FENDER RH  
81612105382  
F2000 6X4 - 8X4



### ZC-M13-029

工程车叶子板LH  
FENDER LH  
81612105381  
F2000 6X4 - 8X40581



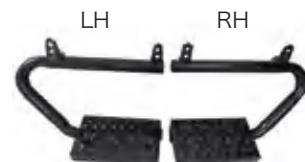

### ZC-M13-030

工程车下台阶板LH/ RH  
STEP LH/ RH  
F2000 6X4 - 8X4



# M90/F90/F2000 TRACTORS FOR MAN



<p><b>ZC-M13-031</b> 杠灯条 END COVER 81416100195 F90</p> 	<p><b>ZC-M13-032</b> 杠灯 SIDE LAMP 81253206087 F90</p> 	<p><b>ZC-M13-033</b> 杠灯铁网 GRILLE 81416100210 F90</p> 
<p><b>ZC-M13-034</b> 杠灯网卡件 HINGE 81416100211 F90</p> 	<p><b>ZC-M13-035</b> 后灯LH TAIL LAMP LH 81252286019</p> 	<p><b>ZC-M13-036后</b> 灯LH TAIL LAMP RH 81252286020</p> 
<p><b>ZC-M13-037</b> 叶子板边灯 SIDE LAMP 85253206004 85253206002</p> 	<p><b>ZC-M13-038</b> 大灯玻璃 HEAD LAMP CLASS 81251100059</p> 	

# FUEL TANKS

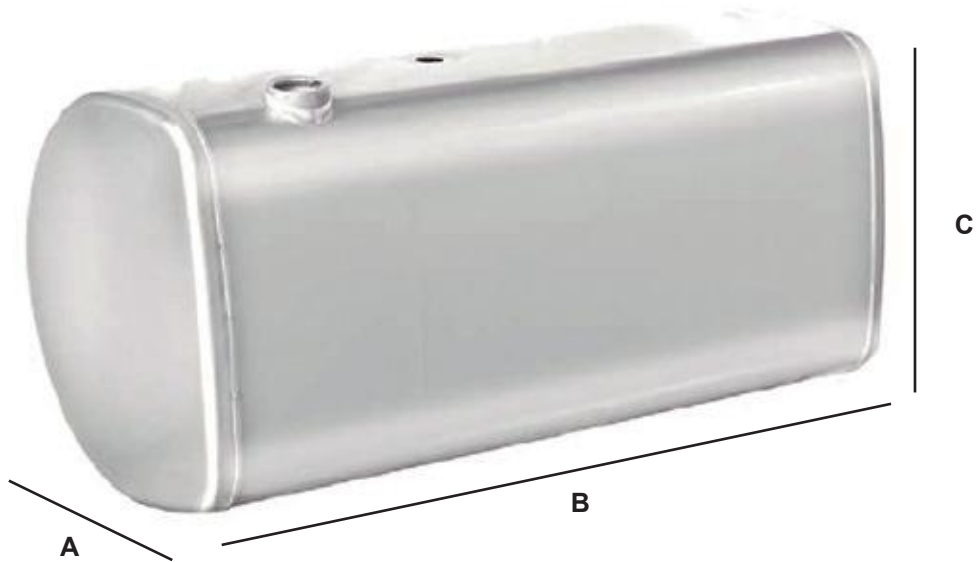

ZC REF.(VOLVO)	OEM NO.	A	B	C	L
ZC-FTVO-001	20503502	69	43	71	165
ZC-FTVO-002	20503503	69	53	71	205
ZC-FTVO-003	24425785	69	71	71	280
ZC-FTVO-004	20503504	69	83	71	325
ZC-FTVO-005	20507744	69	93	71	360
ZC-FTVO-006	20503505	69	103	71	400
ZC-FTVO-007	20503506	69	113	71	445
ZC-FTVO-008	20503507	69	123	71	485
ZC-FTVO-009	20503508	69	133	71	530
ZC-FTVO-010	20503509	69	143	71	565
ZC-FTVO-011	20503510	69	153	71	605
ZC-FTVO-012	20503511	69	163	71	645
ZC-FTVO-013	20503514	69	173	71	685
ZC-FTVO-014	20503516	69	183	71	725
ZC-FTVO-015	20503517	69	203	71	805



# FUEL TANKS

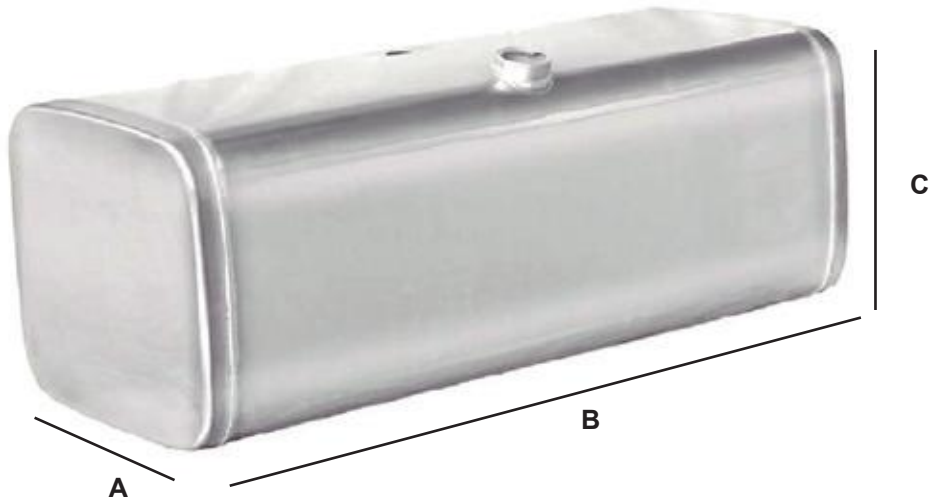

ZC REF.(BENZ)	OEM NO.	A	B	C	L
ZC-FTMB-001	4054700201	64	62	56	200
ZC-FTMB-002	4054700301	64	78	56	250
ZC-FTMB-003	9424700201	64	94	56	300
ZC-FTMB-004	9424700401	64	125	56	400
ZC-FTMB-005	9424700501	64	155	56	500
ZC-FTMB-006	9424700601	64	185	56	590
ZC-FTMB-007		64	189	56	600
ZC-FTMB-008		64	220	56	700

# FUEL TANKS

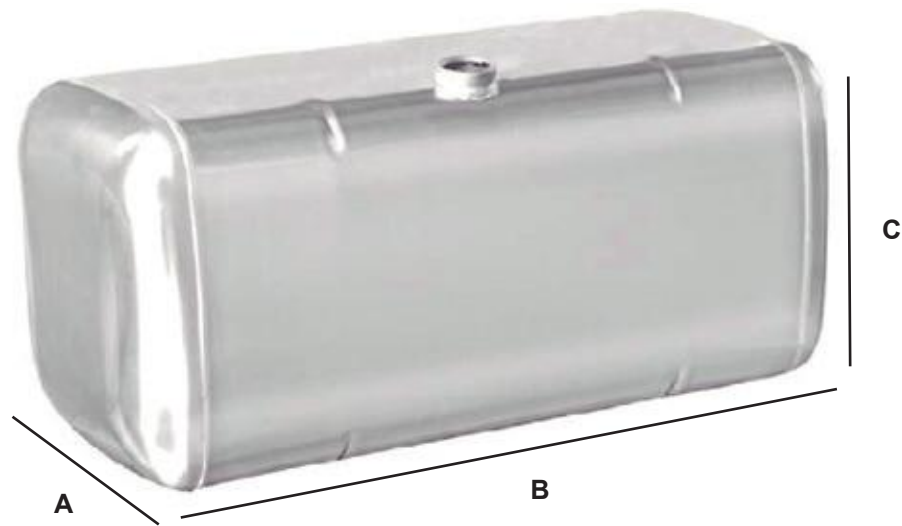

ZC REF.(BENZ)	OEM NO.	A	B	C	L
ZC-FTMB-009	9424701601	69	65	69	280
ZC-FTMB-010	9424701001	69	76	69	300
ZC-FTMB-011	9424701301	69	90	69	400
ZC-FTMB-012	9424701101	69	107	69	450
ZC-FTMB-013	9424701401	69	123	69	550
ZC-FTMB-014	9424700001	69	150	69	650
ZC-FTMB-015		69	160	69	680
ZC-FTMB-016		69	175	69	770

# FUEL TANKS

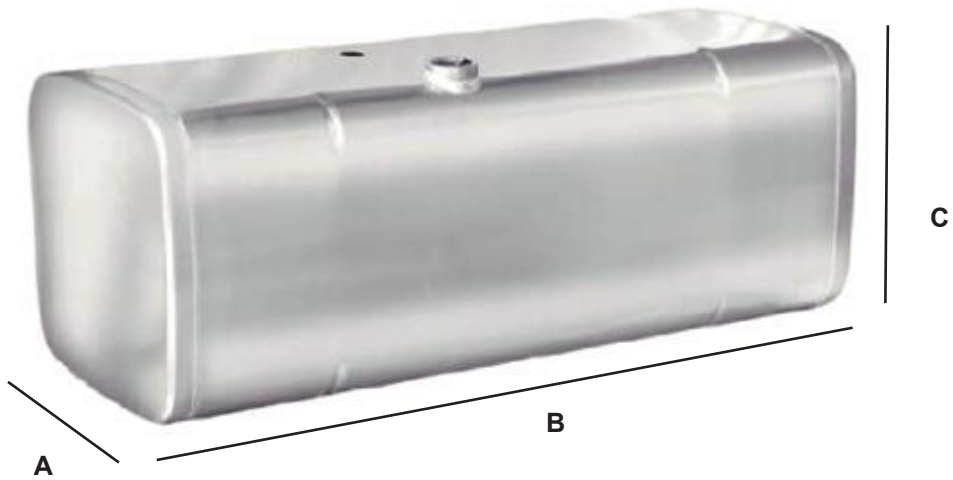

ZC REF.(MAN)	OEM NO.	A	B	C	L
ZC-FTMA-001		67	54	62	200
ZC-FTMA-002	81122015663	67	70	62	250
ZC-FTMA-003	81122015664	67	82	62	300
ZC-FTMA-004	81122015656	67	107	62	400
ZC-FTMA-005	81122015657	67	135	62	500
ZC-FTMA-006	81122015664	67	160	62	600
ZC-FTMA-007	81122015673	67	185	62	700
ZC-FTMA-008		67	200	62	750
ZC-FTMA-009	81122015674	67	208	62	780
ZC-FTMA-010	81122015671	67	214	62	800
ZC-FTMA-011		67	228	62	850

# FUEL TANKS

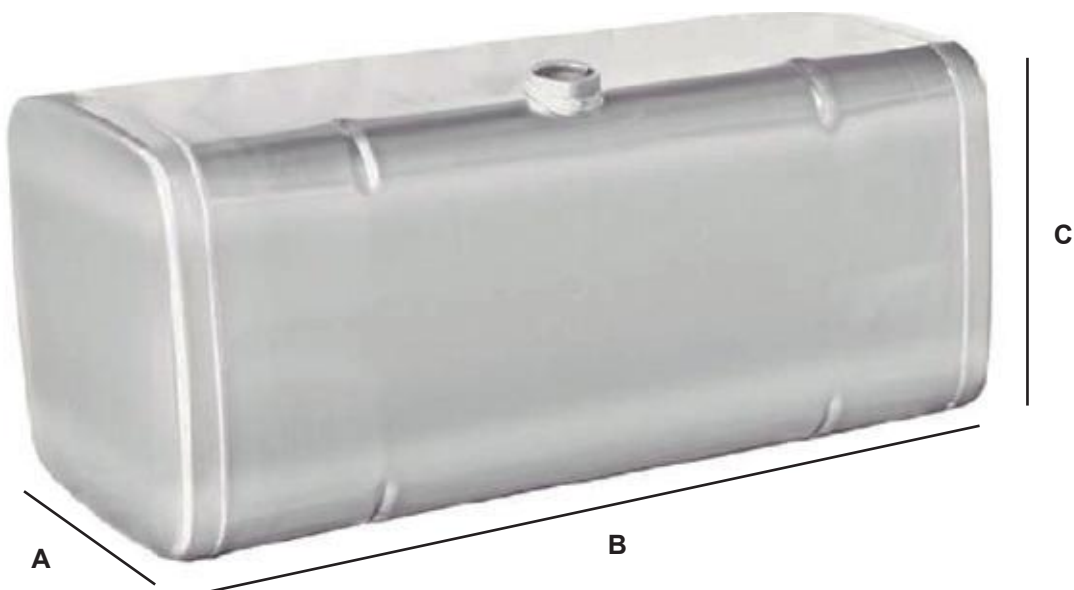

ZC REF.(MAN)	OEM NO.	A	B	C	L
ZC-FTMA-012		70	46	70	200
ZC-FTMA-013	81122015715	70	68	70	300
ZC-FTMA-014		70	90	70	400
ZC-FTMA-015	81122015658	70	106	70	450
ZC-FTMA-016	81122011097	70	115	70	500
ZC-FTMA-017	81122015662	70	136	70	640
ZC-FTMA-018		70	151	70	700
ZC-FTMA-019		70	161	70	780
ZC-FTMA-020		70	170	70	800
ZC-FTMA-021		70	180	70	850
ZC-FTMA-022		70	186	70	880
ZC-FTMA-023		70	206	70	970
ZC-FTMA-024		70	225	70	1050
ZC-FTMA-025		70	230	70	1090

# FUEL TANKS

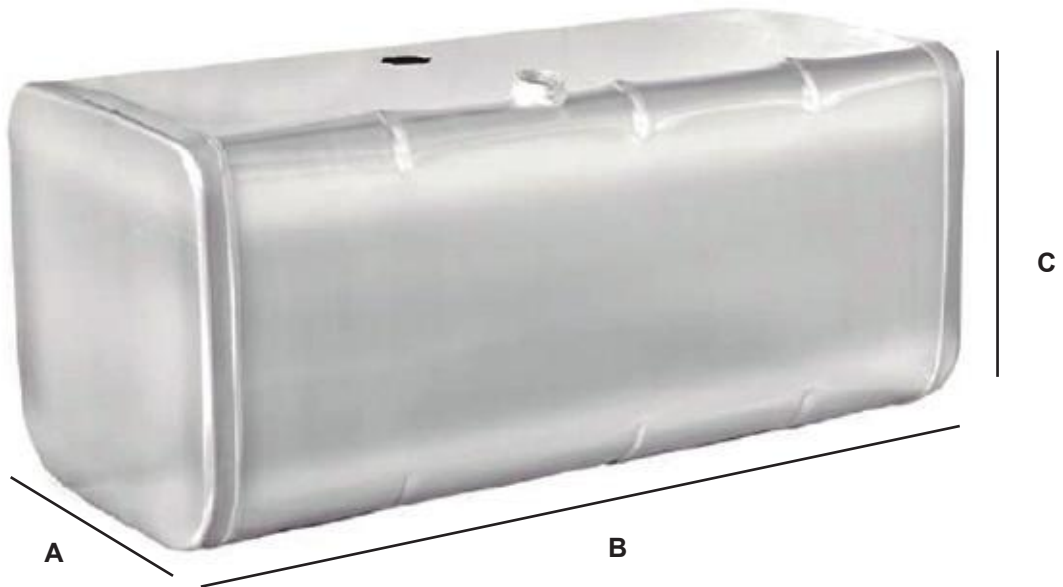

ZC REF.(SCANIA)	OEM NO.	A	B	C	L
ZC-FTSC-001		70	80	67	350
ZC-FTSC-002		70	100	67	450
ZC-FTSC-003		70	130	67	500
ZC-FTSC-004		70	150	67	600
ZC-FTSC-005		70	160	67	700

# FUEL TANKS

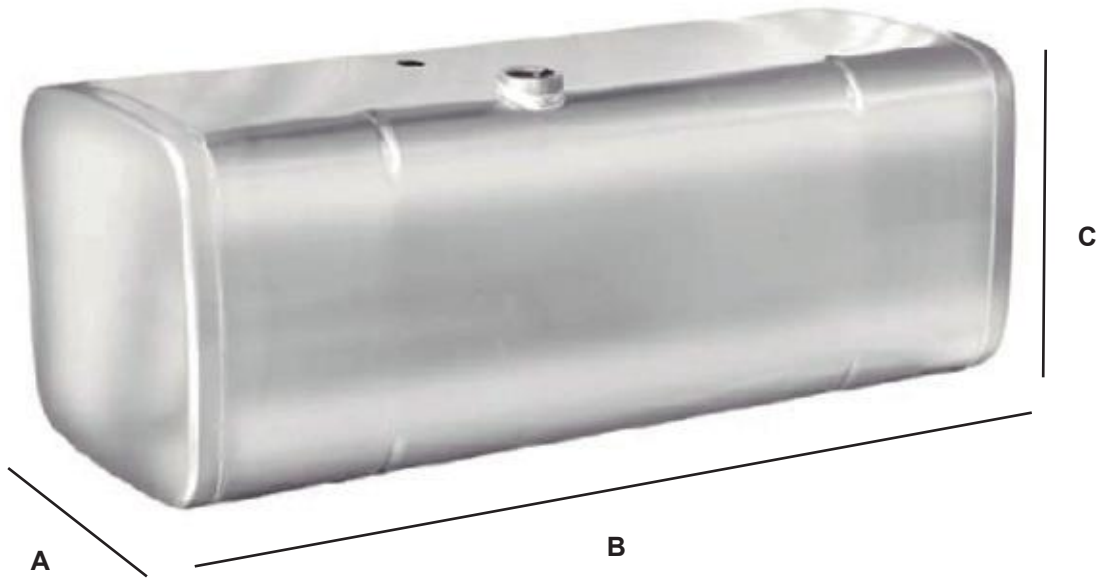

ZC REF.(DAF)	OEM NO.	A	B	C	L
ZC-FTDA-001		67	54	62	200
ZC-FTDA-002		67	70	62	250
ZC-FTDA-003		67	82	62	300
ZC-FTDA-004		67	107	62	400
ZC-FTDA-005		67	135	62	500
ZC-FTDA-006		67	160	62	600
ZC-FTDA-007		67	185	62	700
ZC-FTDA-008		67	200	62	750
ZC-FTDA-009		67	208	62	780
ZC-FTDA-010		67	214	62	800
ZC-FTDA-011		67	228	62	850



# FUEL TANKS

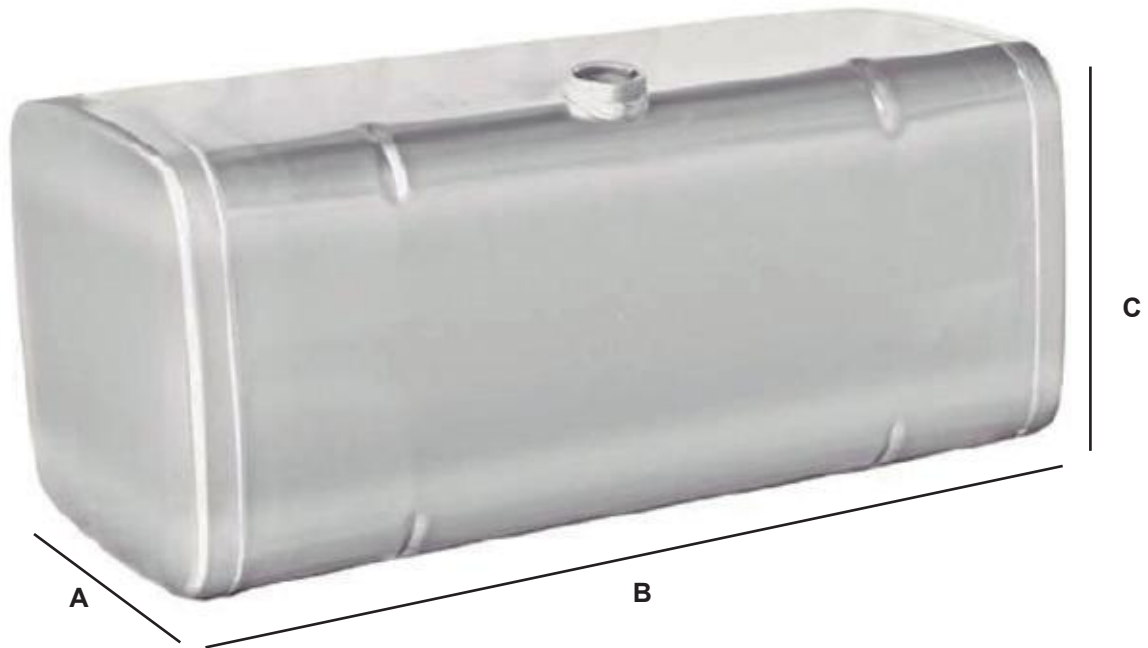

ZC REF.(DAF)	OEM NO.	A	B	C	L
ZC-FTDA-012		70	46	70	200
ZC-FTDA-013		70	68	70	300
ZC-FTDA-014		70	90	70	400
ZC-FTDA-015		70	106	70	450
ZC-FTDA-016		70	115	70	500
ZC-FTDA-017		70	136	70	640
ZC-FTDA-018		70	151	70	700
ZC-FTDA-019		70	161	70	780
ZC-FTDA-020		70	170	70	800
ZC-FTDA-021		70	180	70	850
ZC-FTDA-022		70	186	70	880
ZC-FTDA-023		70	206	70	970
ZC-FTDA-024		70	225	70	1050
ZC-FTDA-025		70	230	70	1090

# FUEL TANKS

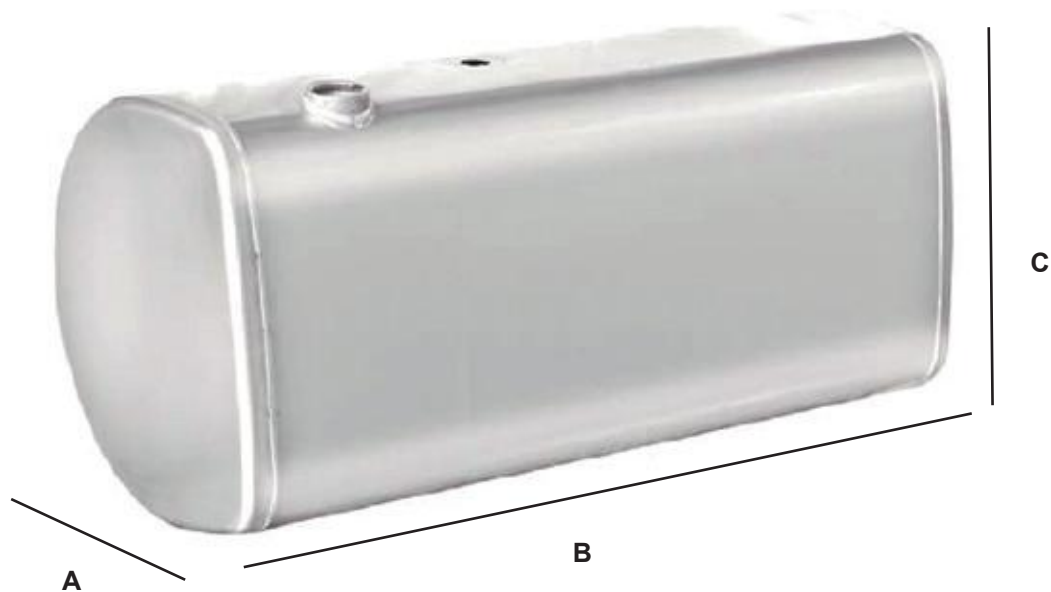

ZC REF.(RENAULT)	OEM NO.	A	B	C	L
ZC-FTRNT-001		69	43	71	165
ZC-FTRNT-002		69	53	71	205
ZC-FTRNT-003		69	71	71	280
ZC-FTRNT-004		69	83	71	325
ZC-FTRNT-005		69	93	71	360
ZC-FTRNT-006		69	103	71	400
ZC-FTRNT-007		69	113	71	445
ZC-FTRNT-008		69	123	71	485
ZC-FTRNT-009		69	133	71	530
ZC-FTRNT-010		69	143	71	565
ZC-FTRNT-011		69	153	71	605
ZC-FTRNT-012		69	163	71	645
ZC-FTRNT-013		69	173	71	685
ZC-FTRNT-014		69	183	71	725
ZC-FTRNT-015		69	203	71	805

# FUEL TANKS

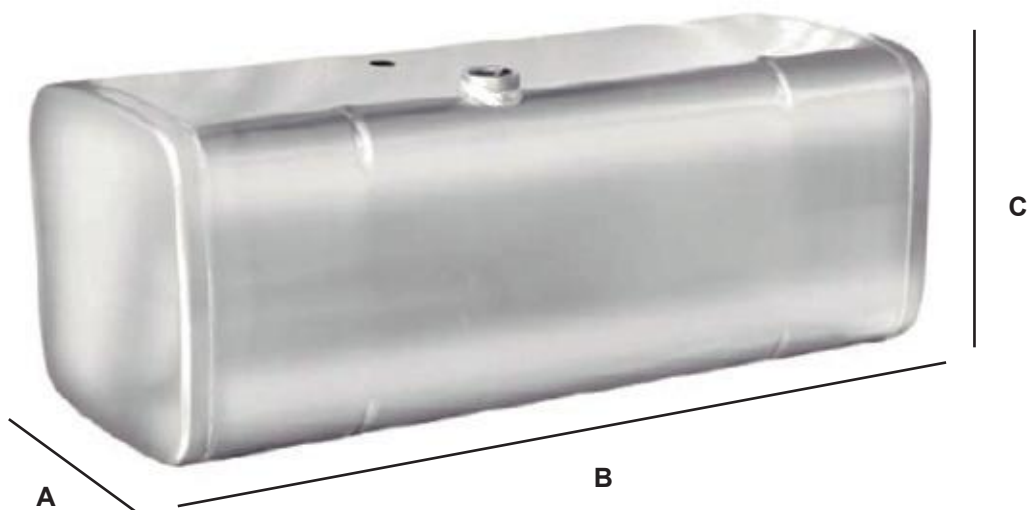

ZC REF.(IVECO)	OEM NO.	A	B	C	L
ZC-FTIV-001		67	54	62	200
ZC-FTIV-002		67	70	62	250
ZC-FTIV-003		67	82	62	300
ZC-FTIV-004		67	107	62	400
ZC-FTIV-005		67	135	62	500
ZC-FTIV-006		67	160	62	600
ZC-FTIV-007		67	185	62	700
ZC-FTIV-008		67	200	62	750
ZC-FTIV-009		67	208	62	780
ZC-FTIV-010		67	214	62	800
ZC-FTIV-011		67	228	62	850

# FUEL TANKS

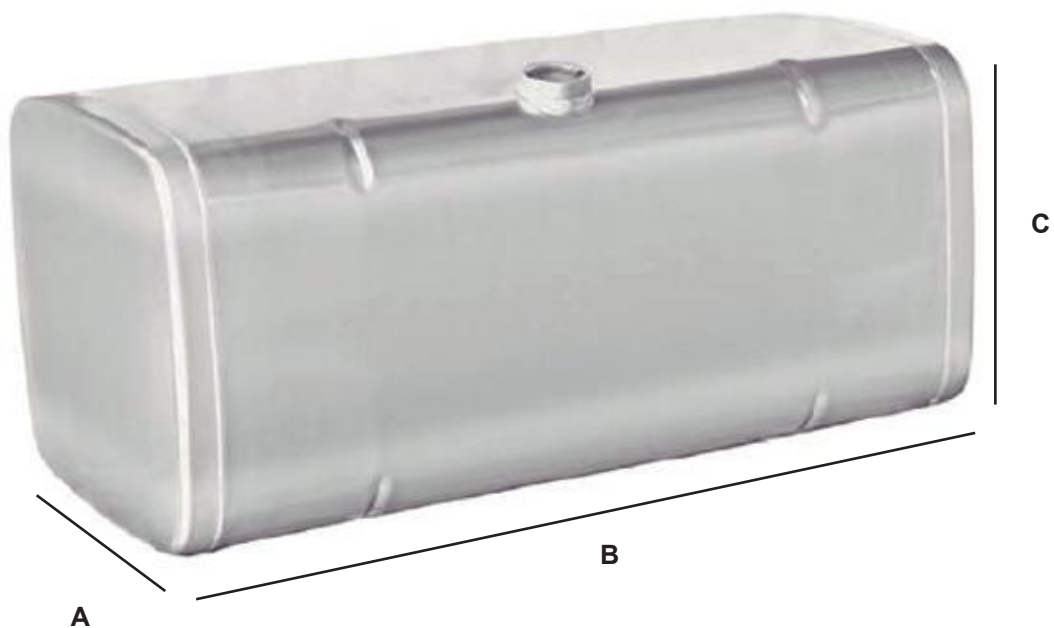

ZC REF.(IVECO)	OEM NO.	A	B	C	L
ZC-FTIV-012		70	46	70	200
ZC-FTIV-013		70	68	70	300
ZC-FTIV-014		70	90	70	400
ZC-FTIV-015		70	106	70	450
ZC-FTIV-016		70	115	70	500
ZC-FTIV-017		70	136	70	640
ZC-FTIV-018		70	151	70	700
ZC-FTIV-019		70	161	70	780
ZC-FTIV-020		70	170	70	800
ZC-FTIV-021		70	180	70	850
ZC-FTIV-022		70	186	70	880
ZC-FTIV-023		70	206	70	970
ZC-FTIV-024		70	225	70	1050
ZC-FTIV-025		70	230	70	1090

# FUEL TANKS

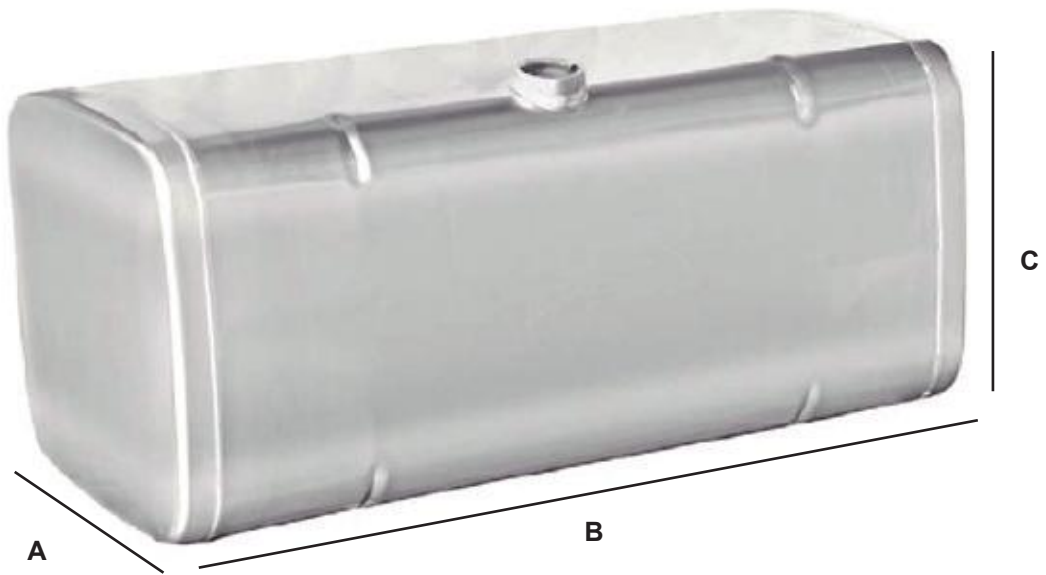

ZC REF.(UNIVERSAL)	OEM NO.	A	B	C	L
ZC-FTUN-001		69	65	69	280
ZC-FTUN-010		69	76	69	300
ZC-FTUN-011		69	90	69	400
ZC-FTUN-012		69	107	69	450
ZC-FTUN-013		69	123	69	550
ZC-FTUN-014		69	150	69	650
ZC-FTUN-015		69	160	69	680
ZC-FTUN-016		69	175	69	770

### ZC-RAD-001

MAN FORTUNA水箱(765\*938\*42mm)(765\*938\*48mm)  
 81061016458 81061016468  
 81061016472 81061016510  
 81061016518  
 RADIATOR  
 MAN FPRTUNA TGA

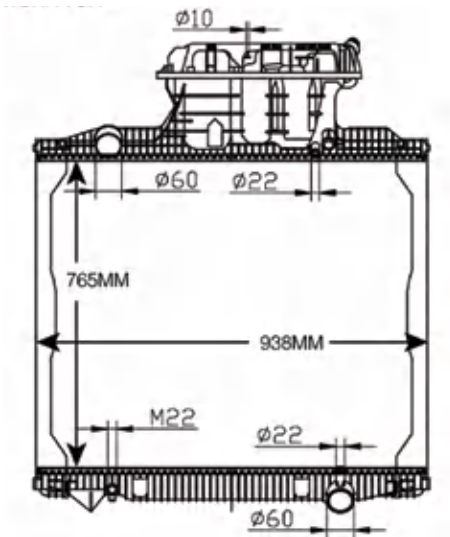

### ZC-RAD-002

MAN FORTUNA水箱(845\*938\*42mm)(845\*938\*48mm)  
 81061016482 81061016511 81061016519  
 RADIATOR  
 MAN FPRTUNA TGA

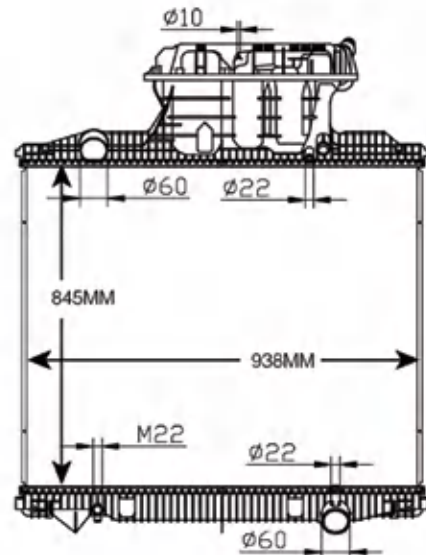

### ZC-RAD-003

MAN FORTUNA水箱(920\*938\*42mm)(920\*938\*48mm)  
 81061016459 81061016462 81061016473  
 81061016477 81061016512 81061016469  
 81061016520  
 RADIATOR  
 MAN FPRTUNA TGA

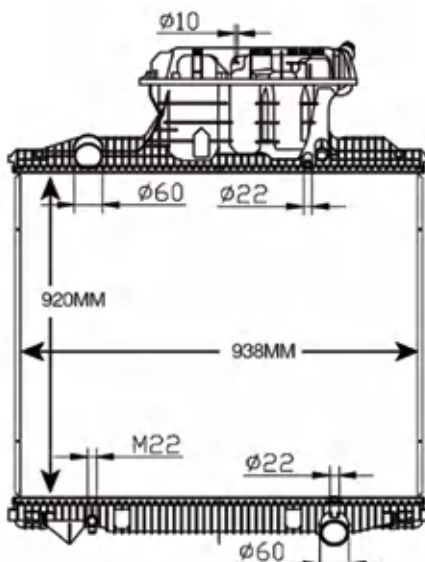

### ZC-RAD-004

F2000' 94 6CY/D28MT水箱(945\*708\*48mm)  
 81061016423 81061016438 81061016407  
 RADIATOR  
 F2000' 94 6CY/D28

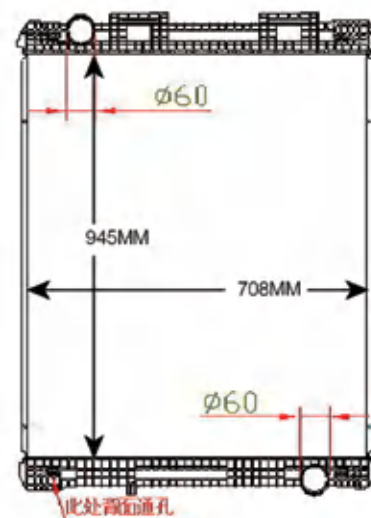



### ZC-RAD-005

F2000' 94 V-10/D28MT水箱(1065\*708\*48mm)  
81061016439  
RADIATOR  
F2000' 94 V-10/D28MT

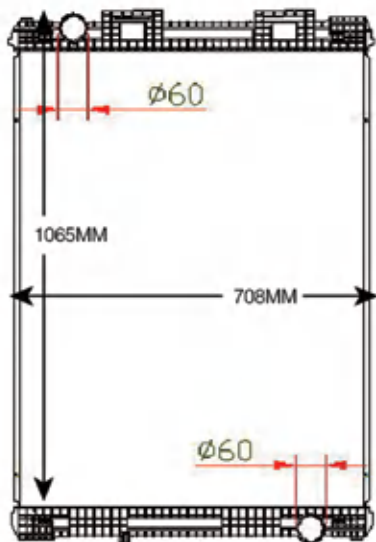

### ZC-RAD-006

BENZ ATEGO水箱(815\*668\*42mm)  
9405000403 9405000203 9405000303  
RADIATOR  
BENZ ATEGO

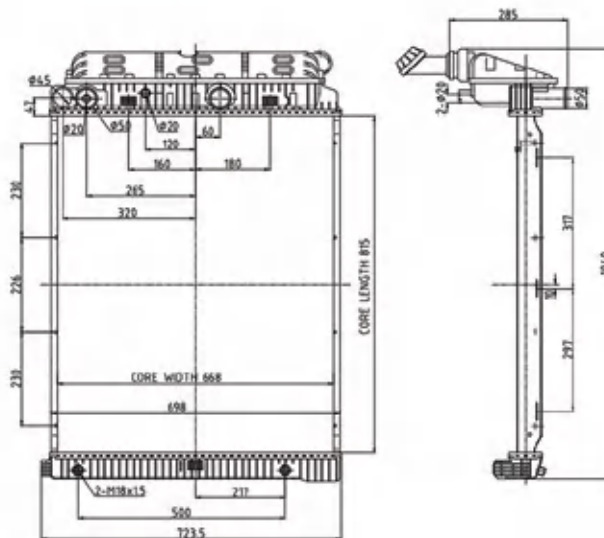

### ZC-RAD-007

中冷器气室上直角(892\*685\*64mm)  
INTERCOOLER  
81061300170 81061300175  
MAN

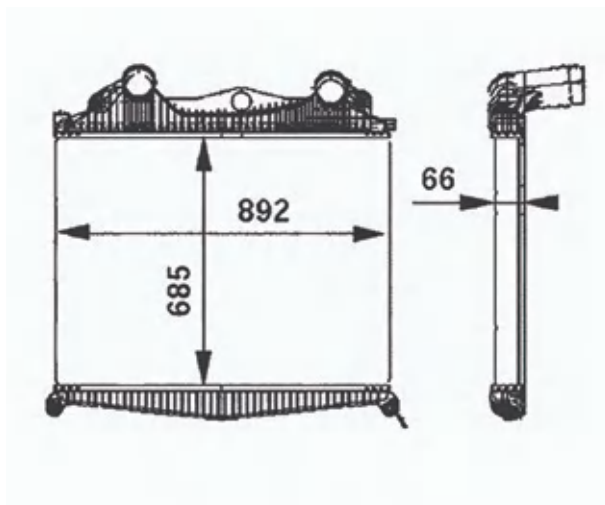

### ZC-RAD-008

中冷器气室上30下度角(892\*685\*64mm)  
INTERCOOLER  
81061300176  
MAN

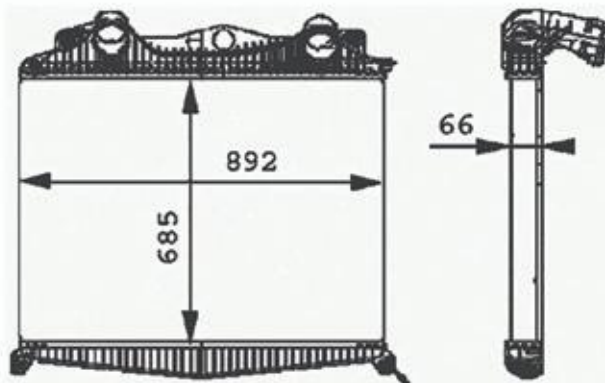

### ZC-RAD-009

中冷器气室上直角(892\*665\*64mm)  
 INTERCOOLER  
 81061300197 81061300215 81061300179  
 81061300204 81061300217  
 MAN

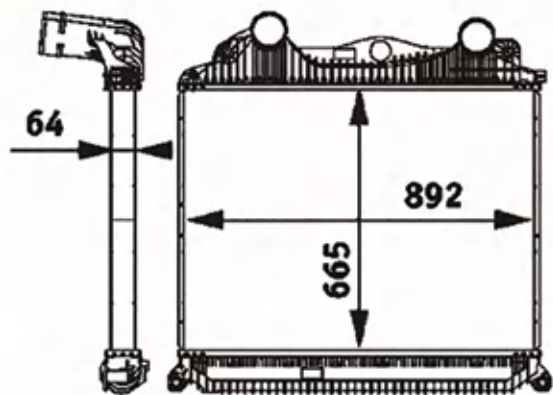

### ZC-RAD-010

中冷器气室上30下度角(892\*665\*64mm)  
 INTERCOOLER  
 81061300205 81061300200 81061300180  
 81061300198 81061300216 81061300203  
 81061300218  
 MAN

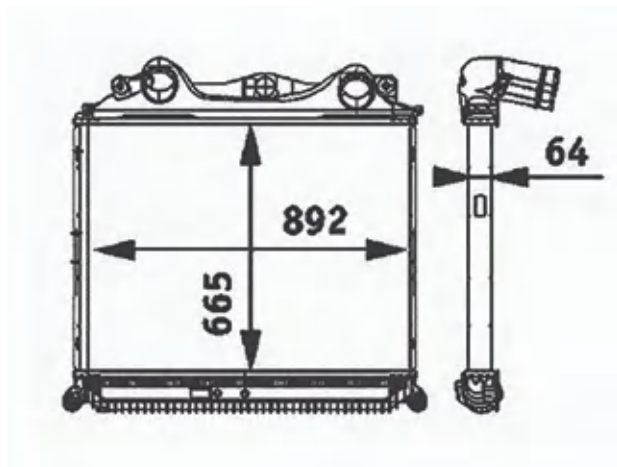

### ZC-RAD-011

曼芯体(配765)  
 CORE(FIT 765)  
 MAN

938MM

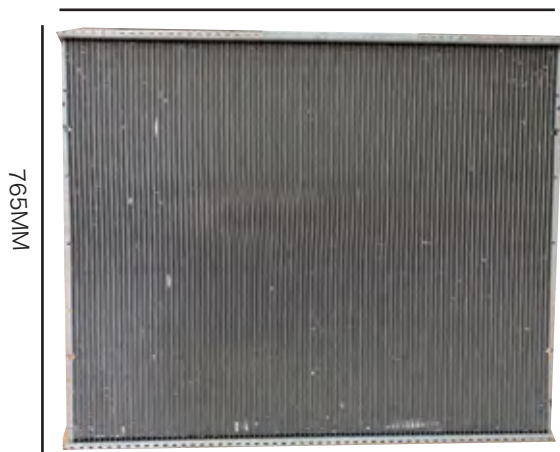

### ZC-RAD-012

曼芯体(配845)  
 CORE(FIT 845)  
 MAN

938MM

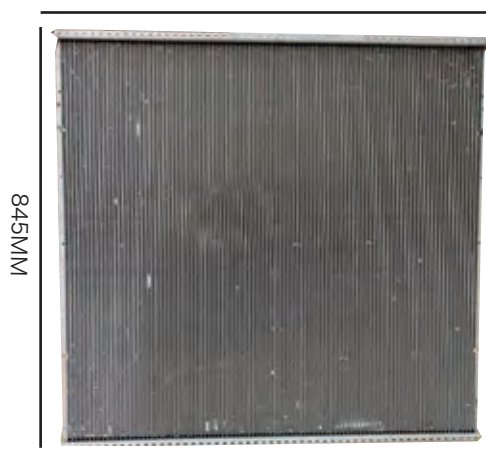

**ZC-RAD-013**  
曼芯体(配920)  
CORE(FIT 920)  
MAN

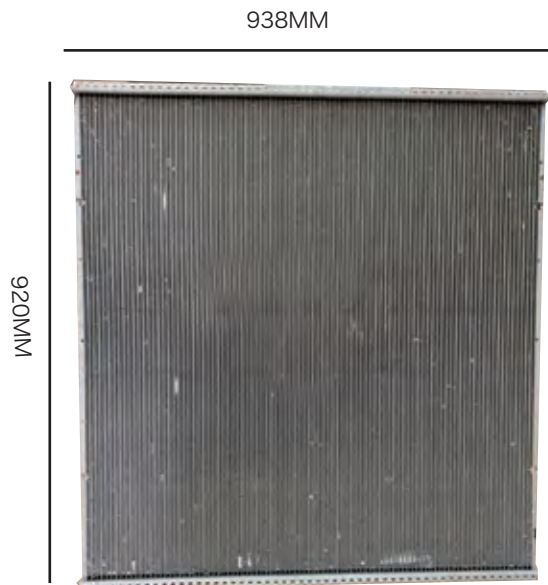

**ZC-RAD-014**  
奔驰芯体  
CORE  
BENZ ATEGO

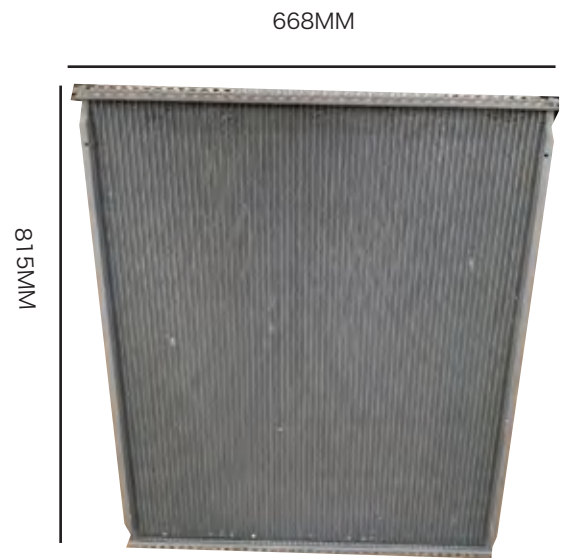

**ZC-RAD-015**  
BENZ ATEGO奔驰中冷器(总成)  
INTERCOOLER  
BENZ ATEGO

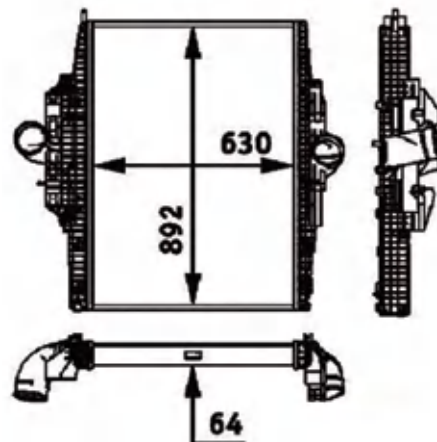

## ZC-RAD-016

曼水室上  
RADIATOR TOP TANK  
MAN

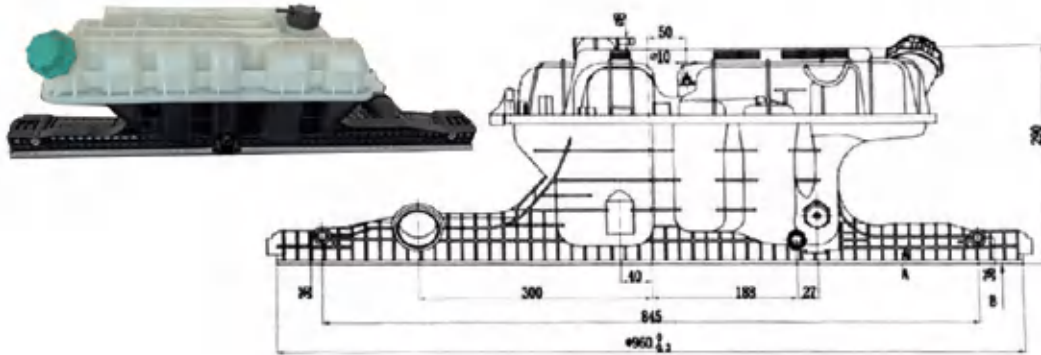

## ZC-RAD-017

曼水室下  
RADIATOR BOTTOM TANK  
MAN

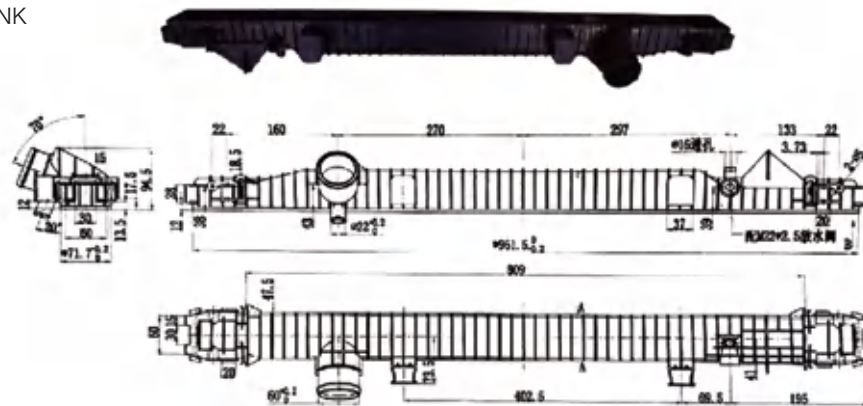

## ZC-RAD-018

曼水箱传感器  
RADIATOR SENSOR  
81274210232 81274210195  
MAN



## ZC-RAD-019

铁侧板(配765)  
SIDE PLATE(FIT 765)  
MAN

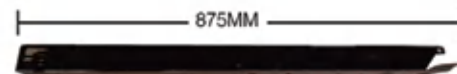

## ZC-RAD-020

铁侧板(配845)  
SIDE PLATE(FIT 845)  
MAN

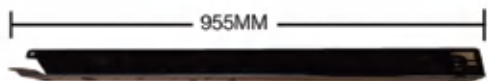

## ZC-RAD-021

铁侧板(配920)  
SIDE PLATE(FIT 920)  
MAN

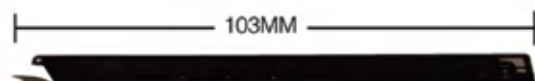

**ZC-RAD-022**  
 曼冷凝器夹具  
 BRACKET  
 81061400161  
 MAN



**ZC-RAD-023**  
 奔驰水室(上)  
 RADIATOR TOP TANK  
 BENZ ATEGO



**ZC-RAD-024**  
 BENZ ATEGO奔驰水室(下)  
 RADIATOR BOTTOM TANK  
 BENZ ATEGO

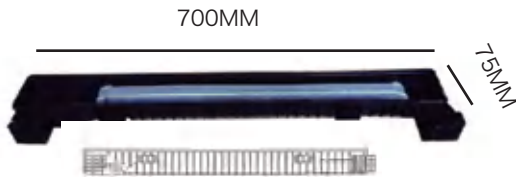

**ZC-RAD-025**  
 奔驰油冷气  
 OIL COOLER  
 BENZ ATEGO



**ZC-RAD-026**  
 BENZ ATEGO奔驰水室(下)(不带油冷器)  
 BOTTOM TANK W/O OIL COOLER  
 BENZ ATEGO



**ZC-RAD-027**  
 奔驰BENZ ATEGO传感器  
 RADIATOR SENSOR  
 9425420217  
 BENZ ATEGO



**ZC-RAD-028**  
 曼气室上直角  
 INTERCOOLER TOP TANK  
 MAN

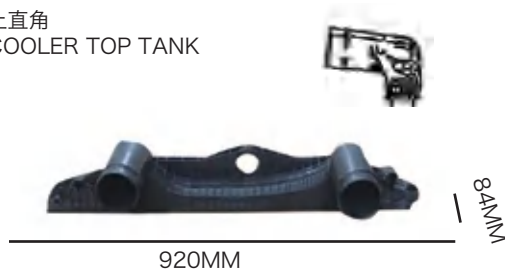

**ZC-RAD-029**  
 曼气室上30下角度  
 INTERCOOLER TOP TANK  
 81061300205 81061300200  
 MAN



**ZC-RAD-030**  
 曼气室下  
 INTERCOOLER BOTTOM TANK  
 MAN 920MM



**ZC-RAD-031**  
 曼气室下  
 INTERCOOLER BOTTOM TANK  
 MAN 920MM

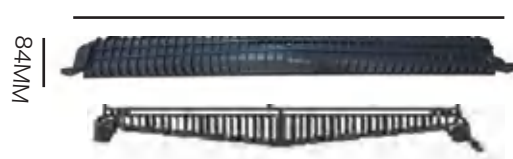

**ZC-RAD-032**

奔驰BENZ ATEGO气室上  
INTERCOOLER BOTTOM TANK  
BENZ ATEGO



**ZC-RAD-033**

奔驰BENZ ATEGO气室下  
INTERCOOLER BOTTOM TANK  
BENZ ATEGO



**ZC-RAD-034**

奔驰BENZ ATEGO气室总成  
INTERCOOLER BOTTOM TANK  
9405010201  
9405010401  
A9405010201  
A9405010401  
BENZ ATEGO

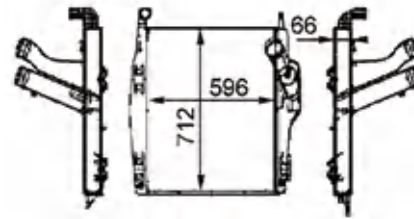

**ZC-RAD-035**

奔驰ATEGO水箱主片  
RADIATOR MASTER SLICE  
BENZ ATEGO



**ZC-RAD-036**

曼气室主片  
INTERCOOLER MASTER SLICE  
MAN



**ZC-RAD-037**

曼水箱主片  
RADIATOR MASTER SLICE  
MAN

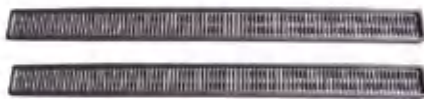

**ZC-RAD-038**

奔驰ATEGO水箱胶条  
RADIATOR TANK GASKET  
BENZ ATEGO



**ZC-RAD-039**

曼中冷器胶条  
INTERCOOLER TANK GASKET  
MAN



**ZC-RAD-040**

曼水箱胶条  
RADIATOR TANK GASKET  
MAN

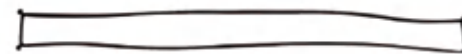



## ZC-RAD-041

堵头  
UPPER RADIATOR PLUG  
81903100615  
MAN



## ZC-RAD-042

排泄口螺塞  
LOWER RADIATOR PLUG  
81903106018  
MAN



## ZC-RAD-043

水箱防虫网  
INSECT-PROOF NET FOR WATER TANK  
81062010124  
EURO6 TGX/TGS  
(765CM)



## ZC-RAD-044

水箱防虫网  
INSECT-PROOF NET FOR WATER TANK  
81062016024  
MAN TGA / TGS  
(845CM)



## ZC-RAD-045

水箱防虫网  
INSECT-PROOF NET FOR WATER TANK  
81062016025  
MAN TGA / TGX  
(920CM)



## ZC-RAD-046

水箱总成 RADIATOR ASSEMBLY  
81061006875  
MAN TGX EURO 6



## ZC-RAD-047

空调冷凝器  
AIR CONDENSER  
81619206041  
EURO6 TGX/TGS



## ZC-RAD-048

水室  
BOTTOM TANK  
EURO6 TGX/TGS



## ZC-RAD-049

气室带铜头  
AIR CHAMBER WITH COPPER HEAD  
TGX/TGS



## ZC-RAD-050

水箱总成  
RADIATOR ASSEMBLY  
81061010075  
EURO6 TGX

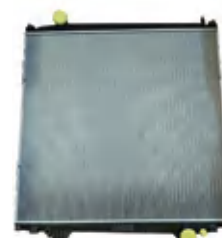

**ZC-RAD-051**

水箱总成  
RADIATOR ASSEMBLY  
81061010074  
EURO6 TGS

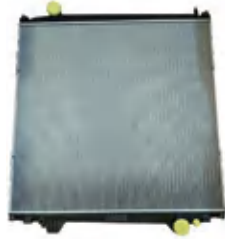

**ZC-RAD-052**

水箱总成  
RADIATOR ASSEMBLY  
81903106025  
EURO6 TGS



**ZC-RAD-053**

风扇罩  
FAN COVER  
81066200201  
EURO6 TGS



**ZC-RAD-054**

81274210152  
F2000 -



**ZC-RAD-055**

水箱盖  
RADIATOR COVER  
81061110020



**ZC-RAD-056**

水箱盖  
RADIATOR COVER  
81061110018



**ZC-RAD-055**

水箱盖  
RADIATOR COVER  
0005016715



## ZC-OFP-001

81018100027  
(106cm)



## ZC-OFP-002

81018106012  
81018100028  
(120cm)



## ZC-OFP-003

81018106010  
(162cm)



## ZC-OFP-004

加油管盖  
FUEL PIPE COVER  
81061110022



## ZC-OFP-005

通风管  
AIR DISCHARGE HOSE  
51018025573 200V01802-5573  
51018025781  
TGX TGS TGA



## ZC-OFP-006

机油管接头  
OIL FILTER PIPE  
81018106027  
MAN



## ZC-OFP-007

机油管  
OIL FILTER PIPE  
81018105093  
MAN



## ZC-OFP-008

机油管  
OIL FILTER PIPE  
81018106014  
81018106008  
81018106035  
TGL-TGM



### ZC-FSD-001

线束MAN  
FRONT SERVICE DOOR  
51254136256  
51254136417  
MAN TG-X TGS TGA



### ZC-FSD-002

线束MAN  
FRONT SERVICE DOOR  
51254136088 51254136104  
MAN TG-X TGS TGA

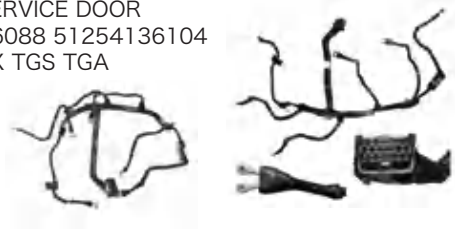

### ZC-FSD-003

线束MAN  
FRONT SERVICE DOOR  
51254136386  
EURO6



### ZC-FSD-004

线束MAN  
CROSS REFERENCE  
51254136418  
51254136179  
51254136281  
MAN



### ZC-FSD-005

线束VOLVO  
FRONT SERVICE DOOR  
20530128



### ZC-FSD-006

线束IVECO  
FRONT SERVICE DOOR  
504389794



### ZC-FSD-007

线束IVECO  
FRONT SERVICE DOOR  
504149934



### ZC-FSD-008

线束IVECO  
FRONT SERVICE DOOR  
504149935



### ZC-FSD-009

线束VOLVO  
FRONT SERVICE DOOR  
22279230



### ZC-FSD-010

线束VOLVO  
FRONT SERVICE DOOR  
22020183



**ZC-FSD-011**

线束VOLVO  
FRONT SERVICE DOOR  
20580978



**ZC-FSD-012**

线束IVECO  
FRONT SERVICE DOOR  
504272883



**ZC-FSD-013**

线束VOLVO  
CROSS REFERENCE  
22041549 21372691  
VOLVO FH/FM/FMX/NH  
9/10/11/12/13/16  
FM13 TRUCK



**ZC-FSD-014**

线束VOLVO  
CROSS REFERENCE  
21776630  
VOLVO FH/FM/FMX/NH  
9/10/11/12/13/16  
FM9,FM11 TRUCK



**ZC-FSD-015**

线束VOLVO  
CROSS REFERENCE  
22248490  
VOLVO  
FM400 TRUCK



**ZC-FSD-016**

线束VOLVO  
CROSS REFERENCE  
22279234 21901481  
21776625  
VOLVO FH/FM/FMX/NH  
9/10/11/12/13/16  
F11 TRUCK



**ZC-FSD-017**

线束IVECO  
CROSS REFERENCE  
5801767837  
IVECO TRUCK



**ZC-FSD-018**

线束VOLVO  
CROSS REFERENCE  
22347607 21822967  
VOLVO  
FM11 TRUCK



**ZC-FSD-019**

线束VOLVO  
FRONT SERVICE DOOR  
20495742



**ZC-FSD-020**

线束VOLVO  
CROSS REFERENCE  
20495742  
VOLVO FM12 TRUCK



**ZC-FSD-021**

线束VOLVO  
CROSS REFERENCE  
20892199



**ZC-FSD-022**

线束VOLVO  
CROSS REFERENCE  
20911558



**ZC-FSD-023**

线束VOLVO  
CROSS REFERENCE  
22020753



**ZC-FSD-024**

线束VOLVO  
CROSS REFERENCE  
20927449



**ZC-FSD-025**

线束VOLVO  
CROSS REFERENCE  
23245790



**ZC-FSD-026**

线束VOLVO  
CROSS REFERENCE  
20593612  
VOLVO TRUCK



**ZC-FSD-027**

线束VOLVO  
CROSS REFERENCE  
22108636 21372461  
20911650 21060810  
VOLVO FH/FM/FMX/NH  
9/10/11/12/13/16  
FM13 TRUCK



**ZC-FSD-028**

线束SCANIA  
CROSS REFERENCE  
1460856



**ZC-FSD-029**

线束RENAULT  
CROSS REFERENCE  
7421545827  
RENAULT



**ZC-FSD-030**

线束MAN  
FRONT SERVICE DOOR  
51254136562





### ZC-RF-001

铝制护风圈  
RING, FAN  
1440407 2149754  
SCANIA



### ZC-RF-002

铝制护风圈 (835)  
RING, FAN  
1511832 1371781 1440404  
SCANIA



### ZC-RF-003

铝制护风圈 (760)  
RING, FAN  
1486148  
SCANIA



### ZC-RF-004

铝制护风圈 (760)  
RING, FAN  
1434106 1788048 1486148  
SCANIA



### ZC-RF-005

铝制护风圈  
RUBBER RING, FAN  
1788048 2212223 2058189  
SCANIA



### ZC-RF-006

铝制护风圈  
RING, FAN  
2214644 2149754  
SCANIA



### ZC-RF-007

铝制护风圈皮  
RUBBER RING, FAN  
1440407  
SCANIA



### ZC-RF-008

铝制护风圈皮  
RUBBER RING, FAN  
1440406  
SCANIA



### ZC-RF-0019

护风罩密封圈  
RUBBER RING, FAN  
1530783  
SCANIA



### ZC-RF-010

护风罩密封圈  
RUBBER RING, FAN  
20440655  
VOLVO



**ZC-RF-011**

铝制护风圈  
RING, FAN  
21301237  
VOLVO



**ZC-RF-012**

铝制护风圈 (845)  
RING, FAN  
20542699  
VOLVO



**ZC-RF-013**

铝制护风圈 (775)  
RING, FAN  
20541083 20542693  
VOLVO



**ZC-RF-014**

铝制护风圈  
RING, FAN  
22134195  
VOLVO



**ZC-RF-015**

护风罩密封圈  
RUBBER RING, FAN  
1674444  
VOLVO



**ZC-RF-016**

铝制护风圈  
RING, FAN  
1332485  
DAF



**ZC-RF-017**

铝制护风圈  
RING, FAN  
1669753  
DAF



**ZC-RF-018**

护风罩密封圈  
RUBBER RING, FAN  
1293797  
DAF



**ZC-RF-019**

铝制护风圈  
RING, FAN  
1953416  
DAF



















**ZC-RF-020**

护风罩密封圈  
RUBBER RING, FAN  
1293767  
DAF



<p><b>ZC-MUD-001</b> 通用挡泥板 UNIVERSALMUDGUARD</p> 	<p><b>ZC-MUD-002</b> 通用挡泥板 UNIVERSALMUDGUARD</p> 	<p><b>ZC-MUD-003</b> 通用挡泥板 UNIVERSALMUDGUARD</p> 
<p><b>ZC-MUD-004</b> 通用挡泥板(带反光片) UNIVERSALMUDGUARD (WITH REFLECTOR)</p> 	<p><b>ZC-MUD-005</b> 通用挡泥板 UNIVERSALMUDGUARD</p> 	<p><b>ZC-MUD-006</b> 通用挡泥板 UNIVERSALMUDGUARD</p> 
<p><b>ZC-MUD-007</b> 通用挡泥板 UNIVERSALMUDGUARD</p> 	<p><b>ZC-MUD-008</b> 通用挡泥板 UNIVERSALMUDGUARD</p> 	<p><b>ZC-MUD-009</b> 通用挡泥板(带压条) UNIVERSALMUDGUARD (WITH RUBBER LAYER)</p> 
<p><b>ZC-MUD-010</b> 通用挡泥板 UNIVERSALMUDGUARD</p> 	<p><b>ZC-MUD-011</b> 通用挡泥板 UNIVERSALMUDGUARD</p> 	<p><b>ZC-MUD-012</b> 通用挡泥板(解放奥威) UNIVERSALMUDGUARD J5P</p> 
		

<p><b>ZC-TRA-001</b> 通用小灯 USE FOR TRAILER</p> 	<p><b>ZC-TRA-002</b> 通用小灯 USE FOR TRAILER 31-2064-017</p> 	<p><b>ZC-TRA-003</b> 通用小灯 USE FOR TRAILER 70015933</p> 
<p><b>ZC-TRA-004</b> 通用小灯 USE FOR TRAILER</p> 	<p><b>ZC-TRA-005</b> 通用小灯 USE FOR TRAILER 70015933</p> 	<p><b>ZC-TRA-006</b> 通用小灯 USE FOR TRAILER</p> 
<p><b>ZC-TRA-007</b> 通用小灯 USE FOR TRAILER E-MARK</p> 	<p><b>ZC-TRA-008</b> 通用小灯 USE FOR TRAILER 81252256182</p> 	<p><b>ZC-TRA-009</b> 通用小灯 USE FOR TRAILER E-MARK WITH SOCKET</p> 
<p><b>ZC-TRA-010</b> 通用小灯 USE FOR TRAILER</p> 	<p><b>ZC-TRA-011</b> 通用小灯 USE FOR TRAILER WITH SOCKET</p> 	<p><b>ZC-TRA-012</b> 通用小灯 USE FOR TRAILER 98241024</p> 
<p><b>ZC-TRA-013</b> 通用小灯 USE FOR TRAILER LED</p> 	<p><b>ZC-TRA-014</b> 通用小灯 USE FOR TRAILER LED 98241084</p> 	<p><b>ZC-TRA-015</b> 通用小灯 USE FOR TRAILER LED 98241014</p> 
<p><b>ZC-TRA-016</b> 通用小灯 USE FOR TRAILER LED</p> 	<p><b>ZC-TRA-017</b> 通用小灯 USE FOR TRAILER LED 98241084</p> 	<p><b>ZC-TRA-018</b> 通用小雾灯 FOG LAMP HID XENON</p> 